

See discussions, stats, and author profiles for this publication at: <https://www.researchgate.net/publication/267095265>

INTRODUCTION TO FISHWAY DESIGN

Technical Report · January 1992

CITATIONS

4

READS

36

2 authors, including:



C. Katopodis

126 PUBLICATIONS 1,646 CITATIONS

SEE PROFILE

INTRODUCTION TO FISHWAY DESIGN

Chris Katopodis, P.Eng.

Freshwater Institute
Central and Arctic Region
Department of Fisheries and Oceans
501 University Crescent
Winnipeg, Manitoba
Canada, R3T 2N6

Ph:(204) 983-5181
FAX:(204) 984-2402

JANUARY 1992

DISCLAIMER This is a working document which is changed from time to time to include new or revised information. Competent advice should be sought with respect to the use and suitability of this information for specific applications. The author and the Government of Canada, Department of Fisheries and Oceans cannot provide any express or implied warranty of any kind in the use of this document, and assume no liability therefor. Anyone using this information assumes all liability arising from such use.

Table of Contents

1 INTRODUCTION	1
2 FISHWAY TYPES	3
2.1 Vertical Slot Fishways	3
2.2 Denil Fishways	4
2.3 Weir Fishways	5
2.4 Culvert Fishways	6
3 DESIGN CONSIDERATIONS	8
3.1 General	8
3.2 Design process	12
4 FISHWAY DESIGN FLOW	13
5 FISHWAY HYDRAULICS	15
5.1 Vertical Slot Fishways	16
5.2 Denil Fishways	20
5.3 Weir Fishways	23
5.3.1 Weir Flow	23
5.3.2 Orifice Flow	24
5.3.3 Weir & Orifice Flow	24
5.4 Culvert Fishways	25
5.4.1 Offset Baffle	26
5.4.2 Weir Baffle	28
5.4.3 Slotted Weir Baffle	29
5.4.4 Fish-Weir	31
5.4.5 Spoiler Baffle	32
6 ICHTHYOMECHANICS	34
7 FISHWAY EFFECTIVENESS	42
7.1 General	42
7.2 Assessment of Denil Fishways for freshwater species	43
8 DESIGN EXAMPLES	51
8.1 Altrude Creek Culvert	51
8.1.1 Fish migration discharge	51
8.1.2 Fish passage design	52
8.2 Hunt Dam Vertical Slot Fishway	55
8.2.1 Design Calculations	57
9 FISHWAY COSTS	60
10 NOTATION	63
11 SELECTED REFERENCES	64
11.1 Fishway Design	64
11.2 Fishway Hydraulics	65
11.3 Ichthyomechanics	67
11.4 Fishway Assessment	67

1 INTRODUCTION

In lakes, rivers and streams fish migrations involve completing a cycle of upstream and downstream movements. This sequence depends on the fish's life stage, its location, and the type of migration. Generally, downstream migration is a feature of early life stages, while upstream migration is a feature of adult life. Fish migrate to spawn, to feed, and to seek refuge from predators or harmful environmental conditions, such as the complete freeze-up of a stream or lake. Should a natural (e.g. a waterfall) or man-made (e.g. a dam, weir, or culvert) obstruction block the stream, fish migration may be slowed or stopped altogether. A fishway is a waterway designed to allow the passage of a species or a number of different species of fish past a particular obstruction. While in most cases fishways are built for adult spawners in some cases migrating juveniles are the target species. For adult fish spawning migrations are usually involved and delays are critical to reproductive success. For juveniles feeding migrations are usually involved and delays are not as critical.

Fish of all ages require freedom of movement to fulfil needs (e.g. reproduction, growth) which cannot be satisfied where they are. Obstructions such as dams or hanging culverts can have long-term effects, while temporary activities (construction of stream crossings) result in short-term stoppages of movement. Spawning migrations are undertaken typically by mature fish, although they are accompanied periodically by immature fish. Some migrations are extensive particularly for catadromous and anadromous species which involve movement to and from the sea. Even within freshwater systems potamodromous species may move more than 100 km. The migration period may take several weeks. Within this time frame there is a relatively short period when most fish migrate. Spawning migration occurs in the spring and fall depending on the species. Obstacles can prevent the passage of fish.

Fish also move from one area to another to feed. These movements may be upstream or downstream and occur over an extended period of time. Before winter freeze-up, fish move downstream to deeper pools for overwintering. This movement is triggered by a reduction in stream discharge. Fry and juvenile fish also show movement in seeking rearing habitat. As they grow older, they require access up and down the stream and into side channels and tributaries to find food and escape predators.

Fish passage over dams and weirs or through culverts is an important consideration in fish bearing streams. Just as adequate design and construction is required for safety, adequate provision for fish passage is required to maintain healthy fish populations. Well designed and constructed fishways provide a path that allow fish to continue migrating past dams, weirs or through culverts without unacceptable delays. Biological requirements such as fish behaviour, motivation, preferences, migration timing and swimming ability drive design and construction criteria for fishways. Although some requirements such as migration timing and the corresponding hydrological conditions in rivers and streams, or swimming performance and fishway hydraulics can be harmonized through rational approaches, other requirements such as species preferences, motivation and behaviour rely heavily on experience and judgement.

Swimming ability is a key component in the successful completion of fish migrations. Fish travelling upstream need to navigate through a variety of flows and water velocities. These range from areas of slow currents, such as pools, wide river sections or reaches of mild stream gradients, to areas of fast currents, such as rapids, narrow sections or reaches with steep gradients. Fish are able to negotiate these conditions by using different levels of swimming performance. Fish swimming performance has been classified into burst speed (highest speed attainable and maintained for less than 15 seconds), prolonged speed (a moderate speed that can be maintained for up to 200 minutes), and sustained speed (a speed maintained indefinitely). In natural waterways, fish mainly use sustained and prolonged speeds when migrating upstream and occasionally use burst speeds to overcome high velocity areas such as rapids.

Fishways allow fish to a) maintain migrations past new hydraulic structures, b) re-establish migrations after years of blockage at man-made barriers, or c) extend migrations upstream of natural barriers. Fishways continue to be a key factor in maintaining salmon stocks in the Columbia River (U.S.A.) by providing access over several hydroelectric dams. Fishways played a vital role in rebuilding the salmon runs in the Fraser River, British Columbia (Canada), after decades of severe population declines attributed to obstruction of spawning migrations. The obstruction was caused by a large rock slide at Hell's Gate Canyon which occurred during railway construction and constricted the river channel. Fishways opened a path over natural falls at the outlet of Fraser Lake, Kodiak Island, Alaska, helped develop and are perpetuating a major salmon run there. These are just a few examples illustrating the usefulness of fishways as mitigation and enhancement measures. A renaissance in fishway research and development has occurred in the last two decades, particularly in North America and Europe. This culminated in the organizing of the first International Symposium on Fishways in Gifu, Japan, in October 1990.

2 FISHWAY TYPES

Fishways usually consist of a sloping channel partitioned by weirs, baffles, or vanes with openings for fish to swim through. The in-channel devices act hydraulically together to produce flow conditions that fish can navigate. Several types of fishways have been developed and are usually distinguished by the arrangement of in-channel devices. Although several variations of each fishway type exist, fishways are classified into vertical slot, Denil, weir and culvert fishways. Excavated channels utilizing rocks, sills or weirs are also used as fishways. The different physical and hydraulic characteristics of each fishway type may make them suitable for some fish species and not suitable for others. Several types of fishways have been developed and the most common are described in sections 2.1-2.4. An effective fishway attracts fish readily and allows them to enter, pass through, and exit safely with minimum cost to the fish in time and energy.

2.1 Vertical Slot Fishways

In the vertical slot fishway, baffles are installed at regular intervals along the length to create a series of pools (Fig. 2.1) Fish easily maintain their position within each pool. Travel between pools, however, requires a burst effort through each slot. Water velocities at the slots remain almost the same from top to bottom. The main advantage of the vertical slot fishway is in its ability to handle large variations in water levels. Usually the difference between water levels in successive pools is 300 mm for adult salmon and 200 mm for adult freshwater fish. Vertical slot fishways usually have a slope of 10%.

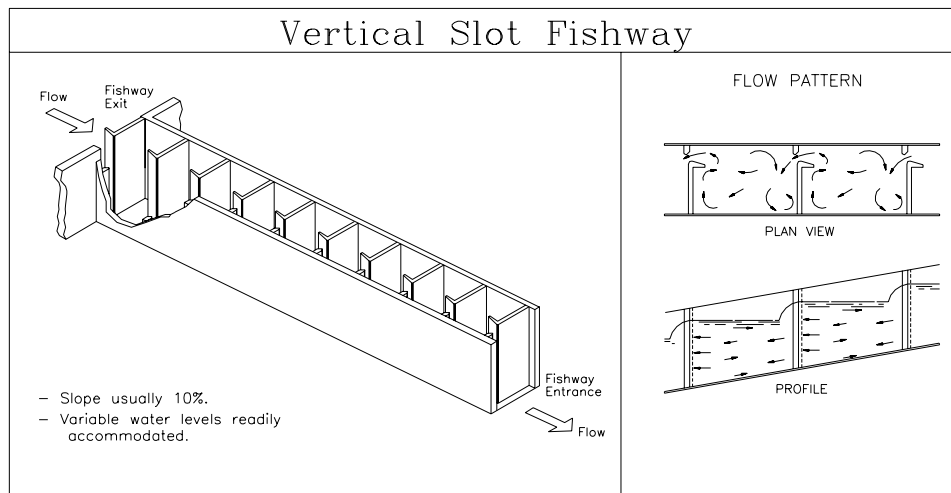

Figure 2.1 Vertical Slot Fishway

2.2 Denil Fishways

Named after its inventor, the Denil fishway consists of a rectangular chute with closely spaced baffles or vanes located along the sides and bottom. Over the years various versions of the Denil fishway have been developed and used for fish passage. Two of the more common Denil fishway types used today are shown in Figure 2.2. The plain Denil contains a series of planar baffles pointing upstream, at an angle of 45 degrees with the fishway floor. Baffles in the steppass Denil also point in the upstream direction but are angled away from the walls of the chute.

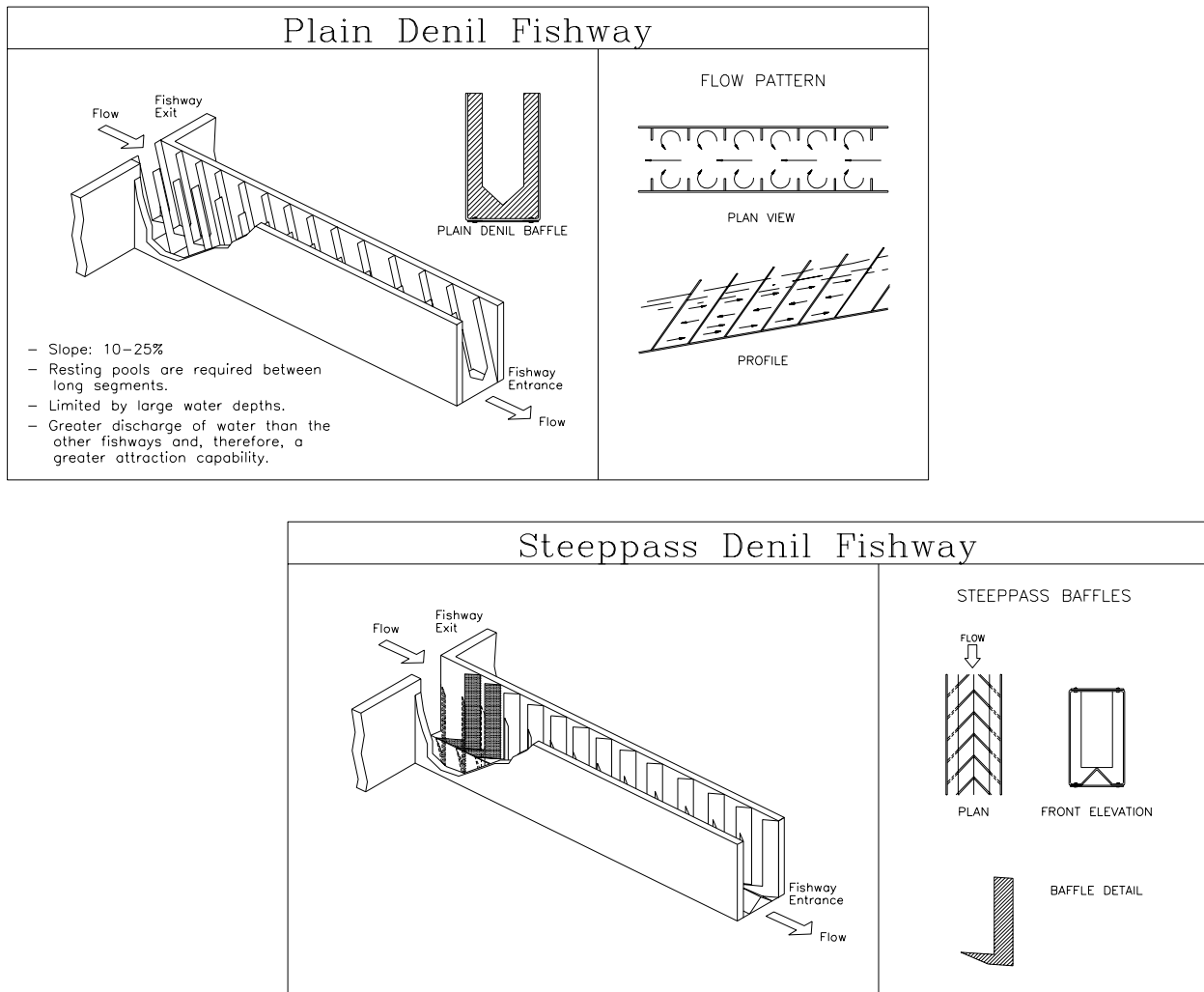

Figure 2.2 Denil Fishways

Flow through Denil fishways is highly turbulent, with large momentum exchange and high energy dissipation. For the plain Denil the water in the chute flows at a relatively low velocity near the bottom with a faster velocity near the top. For the steppass, at low depths velocities tend to be higher near the bottom of the fishway and decrease towards the water surface. At high depths,

flow divides into an upper and a lower layer, and velocity profiles become roughly symmetrical with maximum velocities at mid-depth. The large flow associated with the Denil designs, reduces the deposition of sediment within the fishway and also provides good attraction capability, assisting the fish in finding the fishway. Since fish need to constantly swim while in the chute, resting pools are placed along the fishway every 10 to 15 m for adult salmon and 5 to 10 m for adult freshwater species. Slopes for Denil fishways usually range from 10% to 15% for adult freshwater fish and 15% to 25% for adult salmon.

2.3 Weir Fishways

The weir fishway consists of a number of pools arranged in a stepped pattern separated by weirs, each of which is slightly higher than the one immediately downstream (Fig. 2.3). The fish, attracted by the flowing water, move from pool to pool by jumping or swimming (depending on the water depth) until they have cleared the obstruction. Movement between pools usually involves burst speeds. Fish can rest in the pools, if necessary as they move through the fishway. An orifice may also be added to the submerged portion of the weir allowing the fish to pass through the orifice rather than over the weir. While simple to construct, the pool and weir is sensitive to fluctuating water levels and requires adjustments. The water level drop between pools is usually set at 300 mm for adult salmon and 200 mm for adult freshwater fish. Weir fishways usually have a slope of 10%.

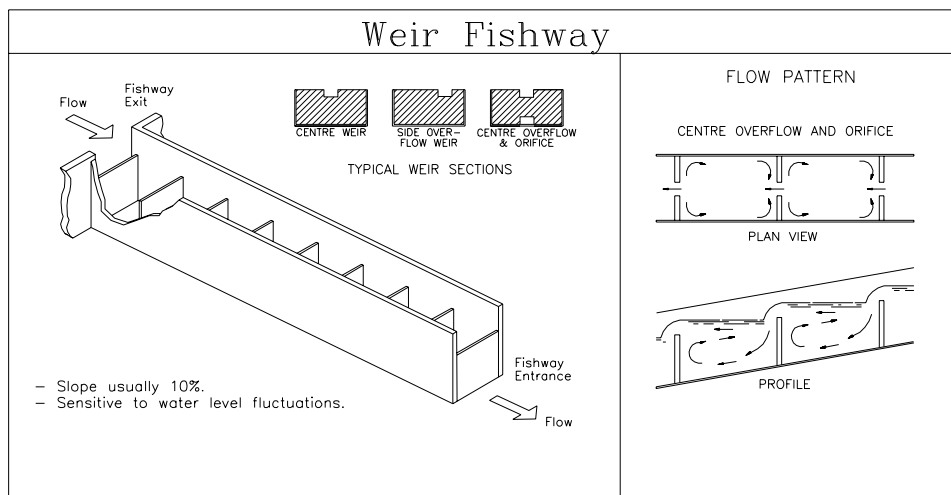

Figure 2.3 Weir Fishway

2.4 Culvert Fishways

Culverts are used to convey water from one side of a roadway embankment to the other. Culverts are built with circular, elliptic, pipe-arch, rectangular or square cross-sections. If a culvert is required to pass fish, special considerations are needed to ensure that fish can enter, pass through and exit the culvert without undue or harmful delay. In many cases culverts are placed below the stream bed and special devices such as riprap, baffles, weirs, blocks or plates are used to form a culvert fishway (Figs. 2.4a & 2.4b). Mainly associated with roadway construction, culvert fishways usually have slopes of between 0.5 and 5%.

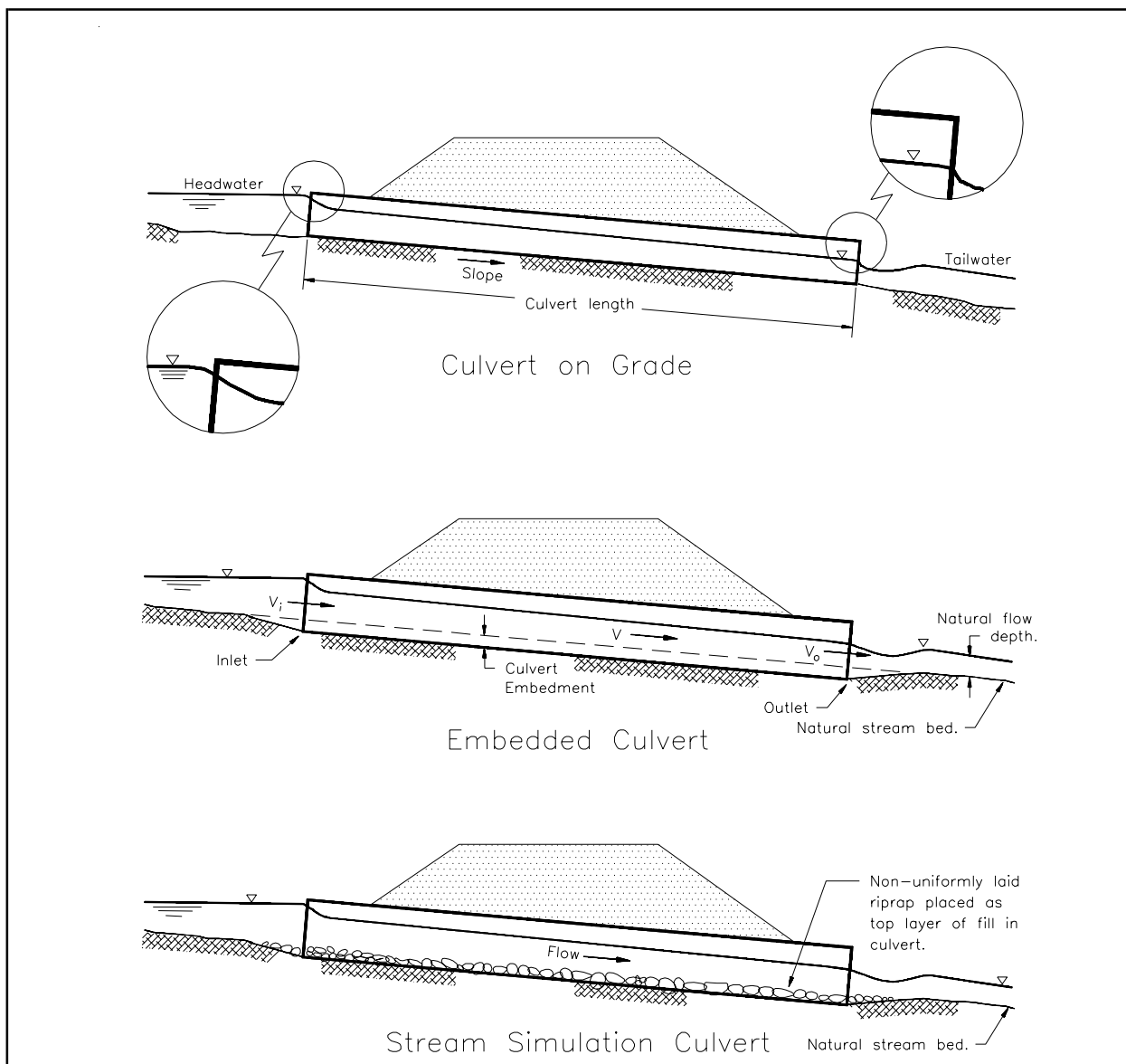

Figure 2.4a Culvert placement.

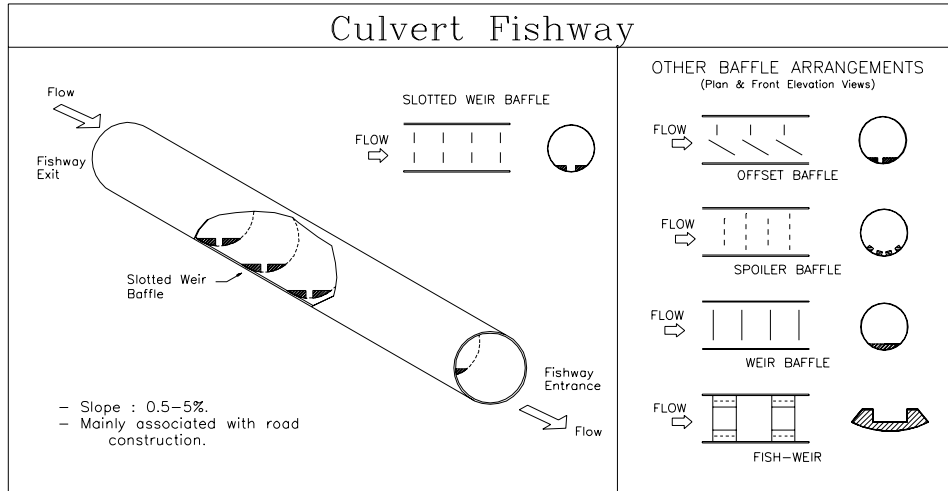

Figure 2.4b Culvert fishway.

3 DESIGN CONSIDERATIONS

3.1 General

In the design of a fishway, important factors to be considered include the hydraulic characteristics of the fishway type, as well as the swimming performance and behaviour of the species of fish to be passed. Biological and hydraulic criteria for designing fishways vary with species and sizes of fish. Fishway efficiency depends on attraction, as well as safe and speedy transport of fish. Attracting fish to the fishway entrance is critical and depends on species behaviour and motivation. Commonly, flows and appropriate water velocities at the entrance are used for fish attraction. Experience with the target species is usually the best guide for designing fishway entrances. In Denils, fast velocities near the water surface provide good attraction conditions at the fish entrance. Backwater conditions reduce fishway velocities, although considerable tailwater levels are usually needed to drown out Denil fishway flows. In vertical slot fishways, slot velocities and fish attraction conditions are affected by backwater when tailwater level exceeds some critical value (generally half of the critical depth in the slot). With slot flows drowned, the entrance pool provides little attraction for fish. Weir fishways are very sensitive to changes in water levels.

The most important factor in selecting the type of fishway to be used is the record of experience with the species of fish it is desired to pass. The Denil and vertical slot fishways have been successfully used by a wide variety of anadromous and freshwater fish. Culvert fishways have also been successful in passing various species. The weir, orifice and orifice-weir fishways have been used successfully by anadromous salmonids, but not readily by alewife, shad and probably other fish that rarely leap over obstacles or swim through submerged orifices. Both the vertical slot and the Denil allow fish to swim at their preferred depth. The Denil provides the most direct route of ascent while in the vertical slot fish use a "burst-rest" pattern to move between pools. Fish move through Denil fishways faster than through vertical slot or weir fishways.

In fishway channels, fish transport relies on water velocities not exceeding the swimming abilities of the migrating species. Swimming ability varies with species, size, as well as water temperature, oxygen, pH, and salinity. Water velocities depend on fishway type, channel slope and water depth. Velocities and depths are functions of fishway discharge and slope. Scale models of various types of fishways have provided velocities and depths for a range of discharges and slopes, as well as the functional relationship between these variables. Field studies with various fish species have tested fishway designs and demonstrated successful applications of fish passage technology.

Weir fishways are frequently the least expensive, while Denil fishways are usually less costly than vertical slot fishways. In Denil fishways effectiveness in water velocity control decreases as water depth increases. Since water velocities in Denils increase with depth, a limit is reached when water velocities start to exceed fish swimming speeds. If larger depths are required a second Denil fishway is needed. Vertical slot fishways maintain water velocities at the slots for very large water

depths. This means that vertical slots can be built as deep as required to cover the entire range of water levels. Water level range and economics play a decisive role on which type of fishway is used.

The main problem with improperly designed and installed culverts is that they form velocity barriers to fish migrants at the outlet, inlet or within the culvert barrel. If water depths are too low or water velocities at any of these three culvert locations exceed fish swimming ability, fish may be prevented from reaching their spawning grounds. Since hydraulic efficiency and optimum fish passage requirements are mutually exclusive objectives, compromises must be effected that permit adequate fish protection with maximum economy. Such compromises involve the matching of water velocities with fish swimming performance at design discharges that allow limited, if any, delay in fish migrations.

Water velocities in plain culverts are usually much higher than those in natural channels. In addition, culverts provide fairly uniform velocities throughout their length, while streams provide a diverse pattern of slow to fast velocities both longitudinally and laterally. Sustained speeds are generally exceeded by culvert velocities, while fish cannot maintain burst speeds long enough to navigate the entire length of most culverts. Prolonged speeds are used for continuous passage through culverts when no resting areas are available. However, fish use a burst and rest pattern to take advantage of low water velocities that are created by the placement of rip-rap, baffles, weirs or other forms of culvert fishways. Consequently, considerable emphasis must be placed on retaining as many qualities of the original stream channel as possible at each crossing.

Migrating fish must negotiate the culvert outlet, the culvert barrel and the culvert inlet before successfully passing upstream. Hydraulic conditions, such as water velocities and depths, at each one of these three locations must be suitable for passage at the highest and lowest stream flows expected during fish migration. Fish need to swim continuously for the entire culvert length when no resting opportunities are available. Culvert length and velocities, as well as maximum distance that fish are able to swim, determine whether fish can pass through a culvert once they enter it.

For culverts, the following three approaches need to be assessed in arriving at a culvert design that satisfies engineering, economic, and fish passage requirements.







- a) plain culvert that meets fish passage velocity (usually 1.2 m/s or less) and minimum water depth criteria (usually 0.2 m at inlet, barrel, and outlet).
- b) stream simulation approach where the status quo in the stream is preserved, i.e. average stream width and slope are maintained up to the fish passage design flow, and stream substrate is kept from washing out either by supports fixed at the culvert bottom or by large stable riprap.
- c) culvert with fish passage devices.

The plain culvert rarely meets fish passage criteria particularly for small fish. Stream simulation or fish passage devices are usually needed. During the design of the Liard Highway, Northwest Territories, Canada, the "stream simulation" concept was advanced for fish passage at culvert

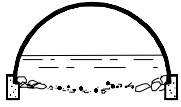
crossings. The stream simulation concept uses stream dimensions to size the culvert and uses large riprap within the culvert to resemble passable natural rapids. In practice, a culvert is selected which is of sufficient size to maintain average stream width and cross-sectional area for the stream discharge during fish migrations. The culvert is (a) set at the average stream slope for the site, (b) placed below streambed, and (c) filled to stream grade. The top layer of the fill is non-uniformly laid riprap, large enough to be stable during the culvert design discharge.

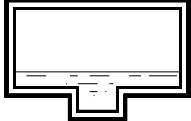
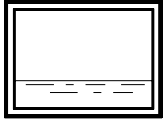
Culverts are the most popular stream crossing structure over other alternatives for economic reasons. The final stream crossing alternative is based on a need for a crossing structure, hydrological conditions, economic factors related to installation and maintenance of the structure, and the natural resource value of the stream. Table 3.1 shows the many types of culverts that are commonly installed along with hydraulic and fisheries design considerations. Designing a culvert that is both economical and allows for the successful movement of fish is not always successful. From an environmental point of view the preferred stream crossing structure is a bridge, especially if there is a known fisheries resource. However, if a culvert is properly designed and installed, it is an acceptable stream crossing structure from both an environmental and economic point of view. Field studies with various fish species have tested culvert fishway designs and demonstrated successful applications of fish passage technology.

Table 3.1 Fisheries and hydraulic considerations for various types of culverts.

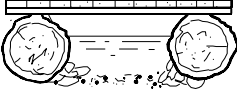
TYPE OF CULVERT	FISHERIES CONSIDERATIONS	HYDRAULIC CONSIDERATIONS
<p>Open Bottom Pipe Arch</p> 	<ul style="list-style-type: none"> Retains natural stream bed and gradient. Water velocities not significantly changed. Can be designed to maintain normal stream width up to fish passage design flow. 	<ul style="list-style-type: none"> Wide bottom area enables passage of high flows while minimizing increases in flow depth. Large waterway opening for low clearance installations.
<p>Open Bottom Box Culvert</p> 	<ul style="list-style-type: none"> Retains natural stream bed and gradient. Water velocities not significantly changed. Can be designed to maintain normal stream width up to fish passage design flow. 	<ul style="list-style-type: none"> Can be designed to maintain normal width of the stream channel. When a large end area is required in low fill, box culverts can be put side by side.
<p>Box Culvert With Trough</p> 	<ul style="list-style-type: none"> Trough concentrates water maintaining fish passage even in low flows. Baffles or culvert fishway can be installed inside. Can be embedded and designed to simulate stream up to fish passage design flow. 	<ul style="list-style-type: none"> Can be designed to maintain normal width of the stream channel. When a large end area is required in low fill, box culverts can be put side by side. Note: Trough can fill with bed load material and create maintenance problems.
<p>Box Culvert</p> 	<ul style="list-style-type: none"> Limits fish passage during low flow due to decreased flow depths. Baffles or culvert fishway can be installed inside. Can be embedded and designed to simulate stream up to fish passage design flow. 	<ul style="list-style-type: none"> Can be designed to maintain normal width of the stream channel. When a large end area is required in low fill, box culverts can be put side by side.
<p>Pipe Arch Culvert</p> 	<ul style="list-style-type: none"> Wide, flat profile allows improved fish passage by back watering the structure. Baffles or culvert fishway can be installed inside. Can be embedded and designed to simulate stream up to fish passage design flow. 	<ul style="list-style-type: none"> Wide bottom area of culvert enables passage of high flows while minimizing increases in the flow depth. Large waterway opening for low clearance installations.
<p>Horizontal Elliptical Culvert</p> 	<ul style="list-style-type: none"> Represents a compromise between pipe arch and round culvert cross-section. Baffles or culvert fishway can be installed inside. Can be embedded and designed to simulate stream up to fish passage design flow. 	<ul style="list-style-type: none"> Squat profile useful in low fill elevations. Shape results in deeper water depth than pipe arch, but does not offer as broad a bottom area.
<p>Stacked Culverts</p> 	<ul style="list-style-type: none"> Allows for fish passage during wider range of flows than single culvert. Baffles or culvert fishway can be installed inside. Can be embedded and designed to simulate stream up to fish passage design flow. 	<ul style="list-style-type: none"> Same hydraulic properties as type of single culvert used (Round, Box, etc.)
<p>Round Metal Culvert</p> 	<ul style="list-style-type: none"> Baffles or culvert fishway can be installed inside. Can be embedded and designed to simulate stream up to fish passage design flow. 	<ul style="list-style-type: none"> Generally constricts stream width and creates high flow velocities with increased chance of scour. Concentrates water during low flows.
<p>Log Culvert</p> 	<ul style="list-style-type: none"> Ensure proper decking to avoid introduction of sediment and debris into the stream. Maintains natural stream bed and gradient. 	<ul style="list-style-type: none"> Exercise care not to restrict stream width. Normally only used as a temporary facility.

3.2 Design process

The information required and the design steps needed to design a fishway for dams, weirs or culverts are outlined below:

1. Obtain a) maps of the project location and drainage basin, b) plan views and profiles of the proposed or existing dam, weir or culvert, c) aerial photos, if available.
2. List fish species which require access to habitat upstream of the project site and the main purpose for such access (e.g. spawning); provide population estimates if available, minimum and maximum length of the species considered for passage.
3. Describe the migration period for each species by giving, where possible, the dates for the start, peak, and end of migration, associated water temperatures, and estimates of peak migrant numbers.
4. Show, whenever possible, locations of spawning, rearing and feeding areas upstream, downstream and at the project site.
5. Perform a flow frequency analysis for the existing or proposed dam, weir or culvert and estimate the following:
 - a) low, average, and high flows (e.g. flows at 98-95% probability of being equalled or exceeded, mean annual flood, bankfull discharge, flows at 10% and 2% probability),
 - b) dam, weir or culvert design flow (e.g. 1:50 year flood) and fishway design flow (e.g. 3-day delay for 1:10 year flood).
6. Prepare stage-discharge relationships for the headwater and tailwater of the existing or proposed dam, weir or culvert.
7. Examine various design alternatives and prepare a short list of feasible options by considering site conditions and dam, weir or culvert characteristics, fish species and sizes, water levels and flows, fish behaviour and stamina, debris and ice, bank protection and stream scour or sedimentation.
8. Prepare a discharge rating curve and characteristic velocity profiles for low, average and high flows for each feasible option.
9. Prepare preliminary engineering report, drawings, and estimate costs. Show fishway dimensions, inverts and elevations, provide plan, side and cross-sectional views, stream bed and bank protection measures and fish passage devices.
10. Ensure review of the preliminary report and drawings. Prepare final report and drawings.
11. Develop a monitoring and evaluation program where desirable; include both biological and hydraulic parameters.
12. Provide a regular maintenance program, particularly to alleviate ice and debris problems.

4 FISHWAY DESIGN FLOW

One of the important tasks in designing a hydraulic structure is the estimation of the design flow through flood frequency analysis. Design flows through fishways are estimated in similar ways except that stream flows during the fish migration period are of primary interest. Another factor that affects the choice of stream flows for analysis is the biological effect of migration delay. Some spawning fish may be able to tolerate short delays in migration. Depending on the species involved excess delay may lead to spawning in marginal areas, reabsorption of spawn, depletion of energy reserves or even mortality. In many cases, particularly with Pacific salmon no delay is required by regulatory agencies. A delay period of less than three days in annual spawning migrations is usually accepted for several freshwater species. Delays longer than three days may be acceptable with 1:10 year frequency. These two criteria are used whenever sufficient data exist to estimate the maximum flow that is likely to prevail at the time of fish migration. This flow, may be used as fishway design flow, and can be estimated directly from existing or reconstructed daily flow records for each species and migration period. Design flows for other delay periods may be estimated in a similar manner.

To create a three day delay discharge frequency curve, first find the three day delay discharge value, Q_{3d} , for each year. Q_{3d} is the largest discharge value which is equalled or exceeded three times in three consecutive days over the fish migration period during a particular year. Set the initial Q_{3d} value equal to the lowest discharge value from the first three daily discharge values for the migration period. Next, determine the lowest discharge for the next three day period, i.e. the lowest discharge from the second, third and fourth days. Compare this discharge with the initial Q_{3d} value, the larger of the two becomes the new Q_{3d} value. Repeat this process for next three day period. This process of comparing values for 3 consecutive days is repeated for the entire migration period.

The Q_{3d} values for each year are then arranged in order of descending magnitude, the largest ranked as number one and the smallest ranked as number "n". The return period, T, for each Q_{3d} value is calculated by dividing the total number of Q_{3d} values plus one (n+1) by the rank number. For example, the return period for the fourth largest Q_{3d} value based on a 32 year record would be equal to 8.25 years, $(32+1)/4$. Return period, T, is then plotted against the corresponding value Q_{3d} on a log-log plot. The points usually plot in a straight line. This line is the frequency curve and is used to estimate other Q_{3d} values. The 1:10 year (T = 10), 3 day delay discharge may then be estimated from this frequency curve. Other more sophisticated methods of estimating return period or probability may also be used in constructing the frequency curve.

The following example illustrates the process of estimating the fishway design flow. The Water Survey of Canada hydrometric record for Redearth Creek was examined for daily flows from September 15 to October 31, corresponding to the fall spawning migration period and from May 1 to June 30 corresponding to the spring migration period. For each year of record (1974-1986) the 3-day delay discharge was selected as shown in Table 4.1. Flows for the 13 year record were ranked and the return period calculated (Table 4.1). Values of flows and return periods were then plotted in log-log format and straight lines were fitted through the data (using the power curve) for each

migration period (Fig. 4.1). The fish passage design flows were then projected as illustrated in Fig. 4.1 and values of $5.3 \text{ m}^3/\text{s}$ and $32.5 \text{ m}^3/\text{s}$ were estimated for the fall and spring spawners respectively. If daily flow records are not available for the stream of interest, the record of another hydrologically similar stream may be used. Flows may then be extrapolated from one stream to the other using methods such as the ratio of drainage areas.

Table 4.1 Redearth Creek three day delay discharge calculation.

Redearth Creek discharge equalled or exceeded once for three consecutive days during the fall and spring fish migration periods (Q_{fall} corresponds to September 15 to October 31; Q_{spring} corresponds to May 1 to June 30). Data from Water Survey of Canada Surface Water Data for Alberta 1974-86.						
Year	Q_{fall} (m^3/s)	Q_{spring} (m^3/s)	Rank #	T (years)	Q_{fall} (m^3/s)	Q_{spring} (m^3/s)
1986	2.07	30.1	1	14.00	5.29	36.2
85	4.32	14.8	2	7.00	4.32	30.1
84	3.34	17.5	3	4.67	4.14	23.3
83	1.89	17.8	4	3.50	3.65	22.1
82	3.63	22.1	5	2.80	3.63	17.8
81	2.81	23.3	6	2.33	3.34	17.5
80	4.14	16.9	7	2.00	3.34	16.9
79	1.92	13.8	8	1.75	2.94	15.7
78	3.65	15.7	9	1.56	2.81	14.9
77	3.34	14.0	10	1.40	2.39	14.8
76	5.29	14.9	11	1.27	2.07	14.0
75	2.94	12.7	12	1.17	1.92	13.8
74	2.39	36.2	13	1.08	1.89	12.7

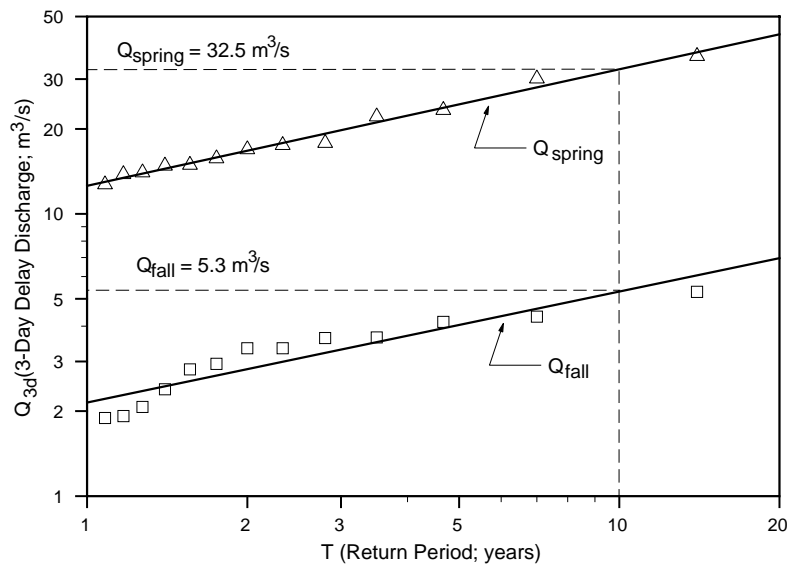

Figure 4.1 Redearth Creek frequency curves (1974-86)

5 FISHWAY HYDRAULICS

The hydraulic characteristics of various types of fishways were studied using geometrically similar scale models. Hydraulic modelling was performed on several variations of vertical slot (18 designs), Denil (6 designs), weir (2 kinds) and culvert (6 kinds) fishways. Discharge rating curves and characteristic velocity profiles for these fishways are available for a wide range of slopes and water depths. Froudian similitude laws were found to reproduce flow phenomena well, and were used for all models to transfer values between model and prototype. In Froudian models gravitational forces predominate, the velocity and time scales are represented by the square root of the geometric scale and the discharge scale is provided by the geometric scale raised to the 5/2 power. Fluid turbulent shear stresses between water jets and recirculating water seem to dominate in fishway flows providing large momentum exchange and high energy dissipation. Neglecting wall shear stresses provides a good approximation for flow analysis. Discharge rating curves were derived using a simple force balance on the predominant flow stream in each fishway type. Applicable to different fishway sizes or scales, dimensionless variables were used to summarize experimental results. For fishway discharge, the corresponding dimensionless variable is usually expressed by:

$$Q_* = \frac{Q}{\sqrt{gS_o b_o^5}} \quad (5.1)$$

where Q is fishway discharge, S_o is slope of the fishway bed, b_o is a characteristic width (e.g. fish passage opening, slot width, orifice width, culvert diameter) and g is gravitational acceleration (constant). Dimensionless discharge Q_* is a linear or a power function of dimensionless depth, y_o/b_o . For most fishway designs tested velocity profiles along a vertical line exhibit similar geometrical shapes. Velocity profile similarity is a property manifested by a large number of turbulent jet flows. Similarity allows the analysis of velocity profiles using dimensionless variables applicable to various fishway sizes or scales. In a typical velocity profile, dimensionless local velocity, u/u_m , is commonly a linear or power function of dimensionless local depth, y/y_o or y/z_o . Here u is the local velocity at a depth y , u_m is the velocity scale representing the maximum values of u , y_o is the total depth and z_o is the height of baffle or weir in culvert fishways. In plain Denil fishways because u_m is not well defined in the profile it is substituted by u_m' , the velocity at 75% of the depth. In vertical slot fishways u and u_m are approximately the same throughout the profile except near the fishway bed. Analogous to the dimensionless discharge Q_* defined above, a dimensionless velocity scale was expressed as:

$$U_* = \frac{u_m \text{ or } u_m'}{\sqrt{gS_o b_o}} \quad (5.2)$$

The dimensionless velocity scale U_* is a linear or power function of y_o/b_o or Q_* and provides an estimate of the maximum velocities in a fishway. Velocity profiles in a fishway may be derived from the similarity analysis and the dimensionless velocity scale.

5.1 Vertical Slot Fishways

A vertical slot fishway (Fig. 2.1) consists of a sloping (or stepped) rectangular channel which is partitioned into pools. Water flows down the channel from pool to pool through slots oriented vertically. A water jet is formed at each slot and energy dissipation by jet mixing occurs in each pool. The hydraulic characteristics of several variations of the vertical slot fishway (Fig. 5.1) were studied by scale models. Both "uniform flow", where depth of flow in each pool (y_o) is approximately the same, and "gradually varied" flow, where M1 or M2 - type backwater curves may occur, were studied. Shear stress between the jet and the recirculating mass predominates, while bed or wall shear stress on the jet is negligible in comparison.

Dimensionless discharge (Q_*) varies linearly with relative depth of flow (y_o/b_o) for the 18 designs tested (Table 5.1; Figure 5.2):

$$Q_* = \frac{Q}{\sqrt{gS_o}b_o^5} = \alpha(y_o/b_o) + \beta \quad (5.3)$$

The maximum velocity in each slot, u_m , is a function of the head drop between pools, h , and is approximated by $\sqrt{2gh}$, if the velocity in the upstream pool is neglected:

$$u_m = \sqrt{2gh} \quad (5.4)$$

Analysis of "gradually varied" flow conditions is important, particularly at the fishway entrance, where fish attraction velocities are reduced by backwater.

Many of the vertical slot designs tested were selected in order to evaluate how hydraulic characteristics change with pool dimensions and baffle geometry. For example, designs 8-13 were tested primarily to find out how sensitive the standard pool length and width are for satisfactory performance. Designs 14-18 are modified versions of Design 1. From the results summarized in Figure 5.2 and Table 5.1, it appears that a pool width of $8b_o$ and a pool length of $10b_o$ are generally satisfactory. Minor variations in these pool dimensions would not seriously affect fishway hydraulic performance. In addition to the widely used designs 1 and 2, designs 6, 16 and 18 are recommended for practical use.

Figure 5.1 Vertical slot fishway design layouts including circulation patterns in pools.

Table 5.1 Vertical slot dimensionless discharge equations.

Design	y_o/b_o range	$Q_* = \frac{Q}{\sqrt{gS_o}b_o^5}$
Design #1	1.90 - 9.02	$Q_* = 3.77(y_o/b_o) - 1.11$
Design #2	2.46 - 9.51	$Q_* = 3.75(y_o/b_o) - 3.52$
Design #3	2.30 - 25.79	$Q_* = 2.84(y_o/b_o) - 1.62$
Design #4	1.77 - 10.79	$Q_* = 5.85(y_o/b_o) + 0.67$
Design #5	2.17 - 13.29	$Q_* = 2.67(y_o/b_o) - 0.52$
Design #6	2.17 - 13.55	$Q_* = 2.71(y_o/b_o)$
Design #7	4.53 - 24.28	$Q_* = 2.91(y_o/b_o) - 3.22$
Design #8	1.93 - 12.62	$Q_* = 1.66(y_o/b_o)$
Design #9	1.97 - 11.61	$Q_* = 1.65(y_o/b_o)$
Design #10	2 - 12.37	$Q_* = 1.4(y_o/b_o)$
Design #11	1.71 - 12.1	$Q_* = 2.98(y_o/b_o)$
Design #12	2.26 - 12.63	$Q_* = 3.11(y_o/b_o)$
Design #13	3.85 - 12.22	$Q_* = 4.13(y_o/b_o)$
Design #14	3.07 - 13.04	$Q_* = 3.21(y_o/b_o)$
Design #15	3.3 - 12.83	$Q_* = 2.89(y_o/b_o)$
Design #16	3.19 - 12.87	$Q_* = 3.59(y_o/b_o)$
Design #17	3.69 - 9.38	$Q_* = 3.27(y_o/b_o)$
Design #18	3.64 - 7.48	$Q_* = 3.71(y_o/b_o)$

Figure 5.2 Variation of dimensionless discharge with relative depth for vertical slot fishways.

5.2 Denil Fishways

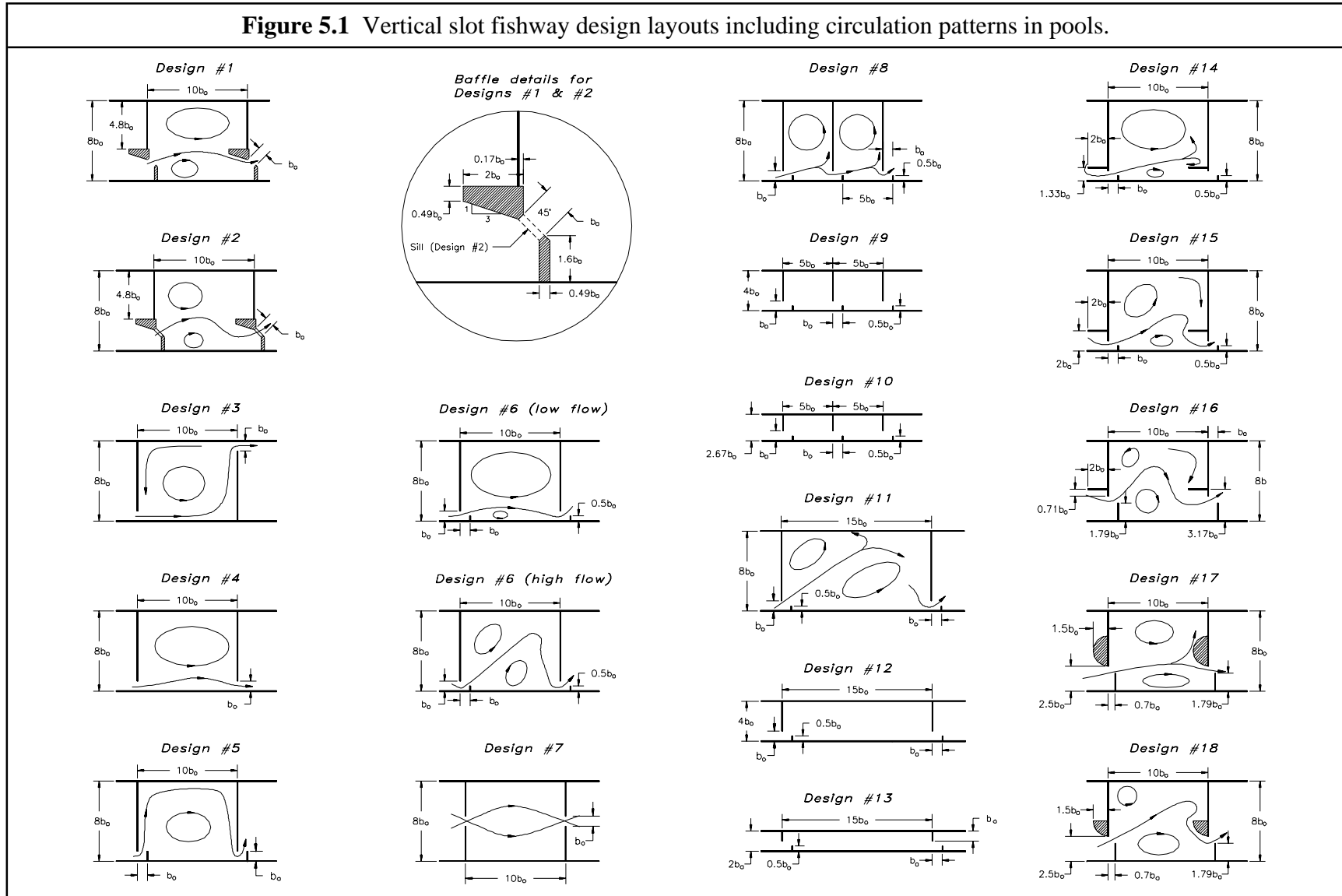
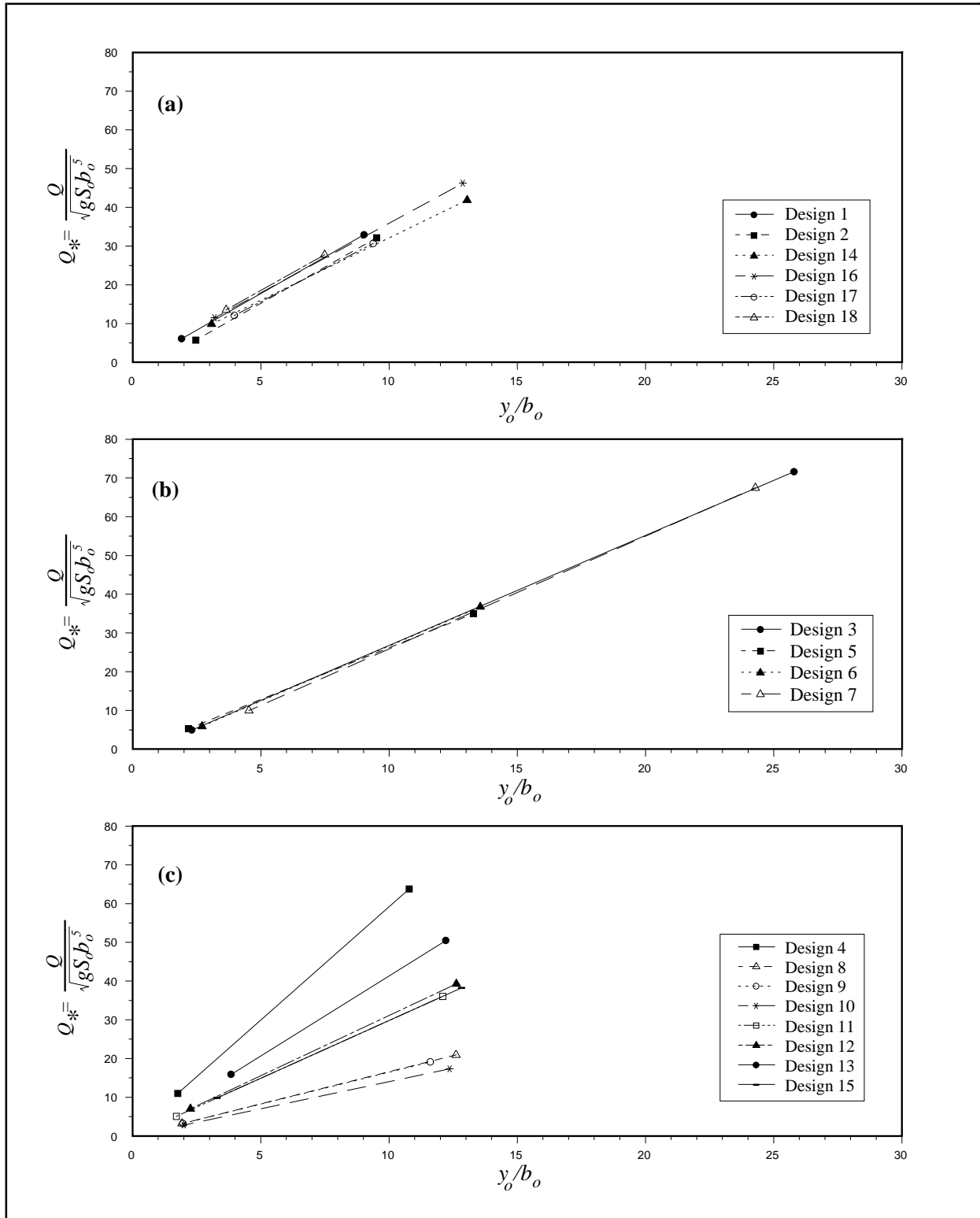
A Denil fishway (Fig. 2.2) consists of a sloping rectangular channel with closely spaced baffles or vanes on the sides and bottom. Flow is highly turbulent, with large momentum exchange and high energy dissipation in the channel. The recirculating mass of fluid between the baffles on the sides and bottom exerts a retarding shear stress on the main flow down the fishway. The hydraulic characteristics of several variations of Denil fishways were studied by scale models both for "uniform" and "gradually varied" flow. A version of the steppass with side baffles at an angle to the walls (Fig. 5.3; design 1) and the plain Denil with planar baffles normal to the walls and at an angle to the floor were investigated (5 baffle spacings; designs 2-6).

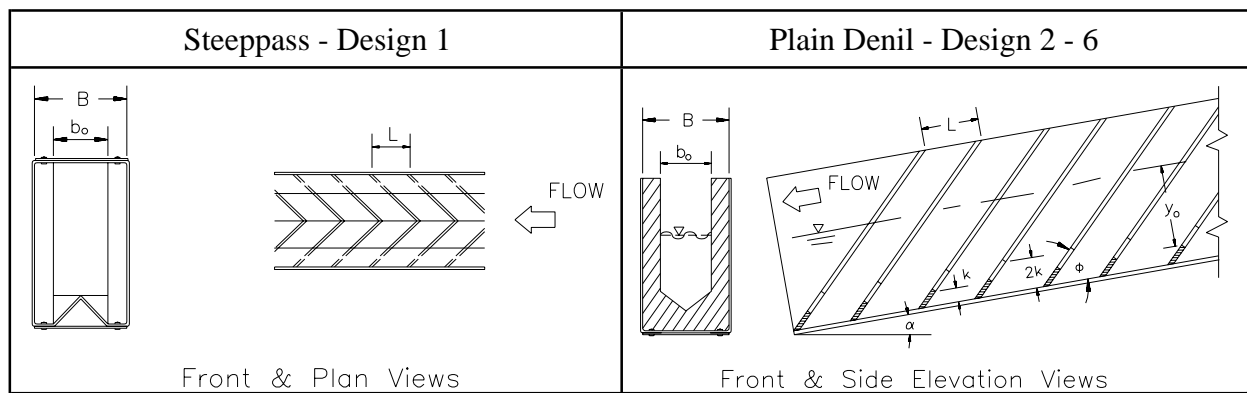

Figure 5.3 Denil fishway design layouts.

Dimensionless discharge (Q_*) is a curvilinear (power) function of relative depth of flow (y_o/b_o) as shown in equation 5.5 (Table 5.2; Fig. 5.4).

$$Q_* = \frac{Q}{\sqrt{gS_o}b_o^5} = \alpha(y_o/b_o)^\beta \quad (5.5)$$

A comparison between the steppass (Denil 1) and the standard Denil (Denil 2) reveals that for $y_o/b > 1.0$ the flow carrying capacity of the standard Denil is larger than that of the steppass. The reverse is true for $0.5 < y_o/b < 1.0$ (Fig. 5.4). Denils 3-6 carry more flow than the steppass (Denil 1) for the range of depth measurements (Fig. 5.4).

Velocity profiles at the central plane of Denil fishways have characteristic shapes which depend mainly on the y_o/b_o ratio. Velocity profiles for different spacings of the baffles in the plain Denil (Fig. 5.3; designs 2-6) are similar, with velocities increasing from the bottom of the channel towards the water surface. For a given slope higher depths result in higher velocities and fishway functionality becomes limited by fish swimming ability. Introducing a new fishway floor at an appropriate depth, increases the range of water depths over which the fishway functions well. The shape of characteristic velocity profiles for the steppass (Fig. 5.3; design 1) are different than those of the plain Denils tested. For the steppass velocities decrease from the channel bottom towards

the surface for $y_o/b_o \leq 1.2$ (and $Q_* \leq 1.2$). For higher y_o/b_o ratios, flow is divided into lower and upper regions, with velocity profiles becoming roughly symmetrical and the maximum velocity at mid-depth.

Table 5.2 Denil fishway dimensionless discharge equations and velocity scales. Note that Denil 1 is the same as steeppass (Model A); u_m applies only to Denil 1 and u_m' to Denil 2-6.

Design	B/b_o	L/b_o	y_o/b_o range	$Q_* = \frac{Q}{\sqrt{gS_o b_o^5}}$	$U_* = \frac{u_m \text{ or } u_m'}{\sqrt{gS_o b_o}}$
Denil 1	1.58	0.715	0.1 - 4.0	$Q_* = 0.97(y_o/b_o)^{1.55}$	$U_* = 1.43(Q_*)^{0.48}$
Denil 2	1.58	0.715	0.5 - 5.8	$Q_* = 0.94(y_o/b_o)^2$	$U_* = 0.76(Q_*)^{0.61}$
Denil 3	1.58	1.07	0.5 - 1.2	$Q_* = 1.12(y_o/b_o)^{1.16}$	
Denil 4	2	0.91	1 - 5	$Q_* = 1.01(y_o/b_o)^{1.92}$	$U_* = 0.84(Q_*)^{0.58}$
Denil 5	2	1.82	1.3 - 4.6	$Q_* = 1.35(y_o/b_o)^{1.57}$	$U_* = 0.67(Q_*)^{0.57}$
Denil 6	2	2.58	0.8 - 4.3	$Q_* = 1.61(y_o/b_o)^{1.43}$	$U_* = 1.37(Q_*)^{0.25}$

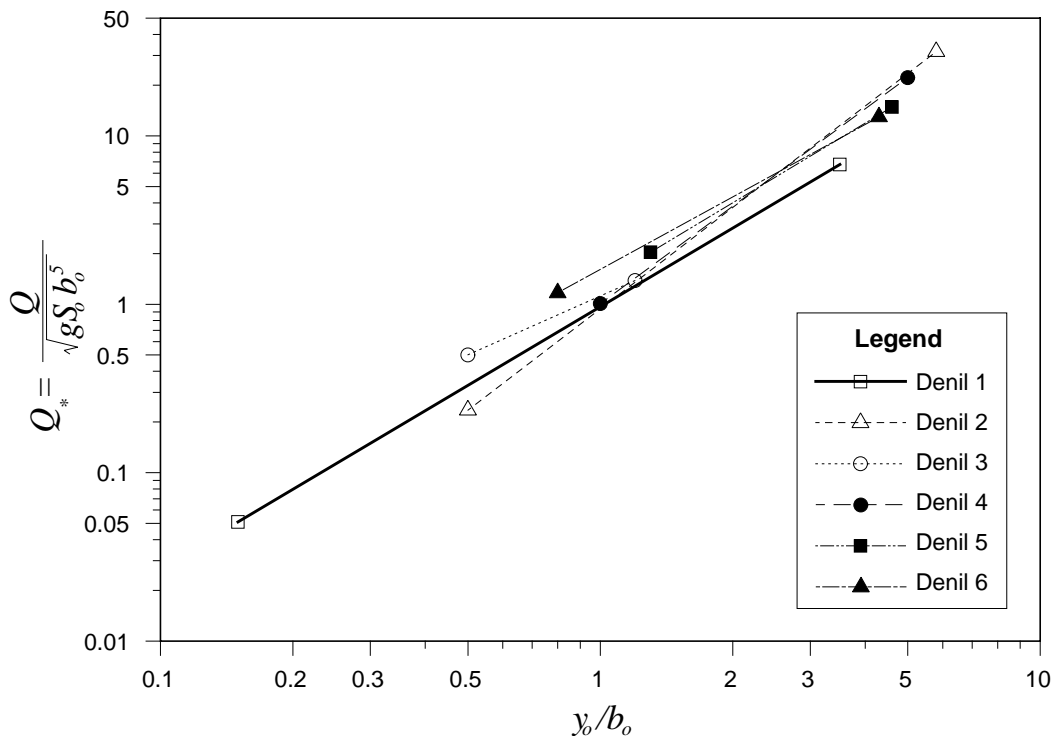

Figure 5.4 Denil fishway dimensionless discharge curves.

Dimensionless velocity scale (U_*) is a curvilinear (power) function of dimensionless discharge (Q_*) as shown in Fig. 5.5 and Table 5.2:

$$U_* = \frac{u_m \text{ or } u_m'}{\sqrt{gb_o S_o}} = \alpha Q_*^\beta \quad (5.6)$$

It is important to note that both u_m and u_m' were estimated from velocity profiles at a centreline vertical. But u_m is the maximum velocity in the profile and applies only to Denil 1 (steppass), while u_m' is the maximum velocity at 75% of the water depth in the fishway and applies to Denil 2-6. Because, the two velocity scales u_m and u_m' are defined differently, values of the dimensionless velocity scales (U_*) from Fig. 5.5 and Table 5.2 can only be compared directly for Denil 2-6. For example, U_* for Denil 6 appears higher than U_* for Denil 2 and 4 for $Q_* < 5$ and lower for $Q_* > 5$.

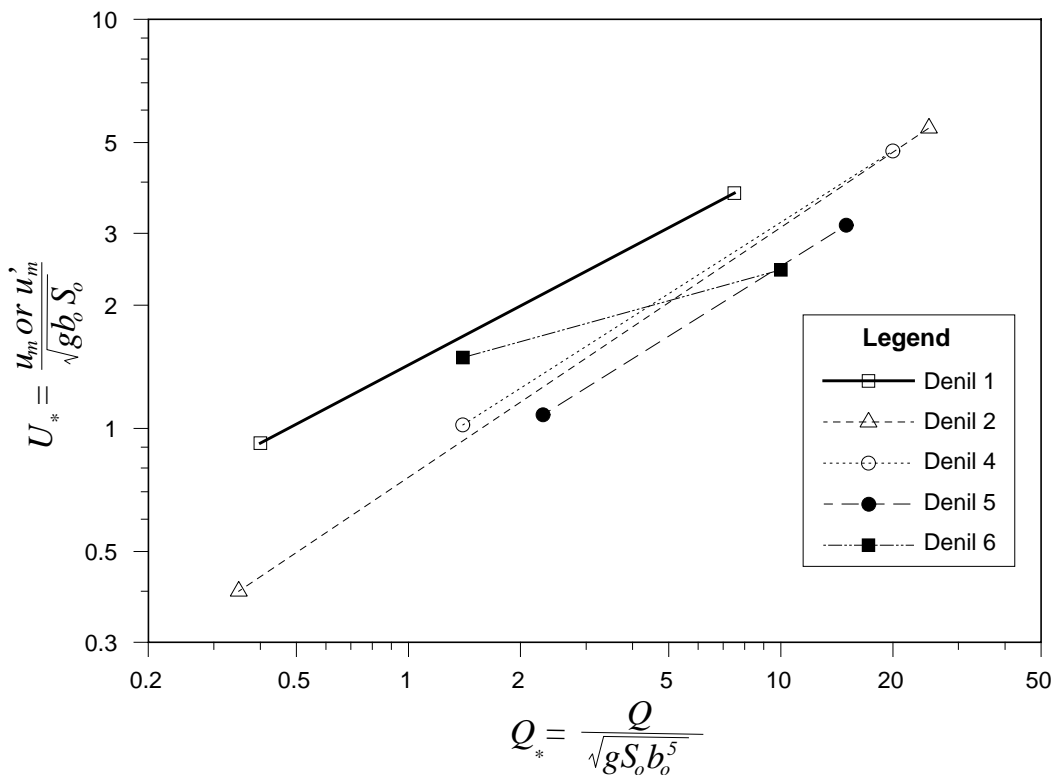

Figure 5.5 Denil fishway dimensionless velocity scales.

5.3 Weir Fishways

A weir fishway (Fig. 2.3) consists of a sloping (or stepped) rectangular channel partitioned into pools by weirs. Water flows a) over the weirs, b) through orifices placed at the bottom of the weirs, or c) both over the weirs and through the orifices. Weir design modifications to stimulate maximum leaping ability by fish or to swim through chutes have also been reported.

5.3.1 Weir Flow

Flow over the weirs is either "plunging" or "streaming", depending on the depth of flow for a given slope and pool length. In the plunging mode hydraulic head, h , above each weir produces a water jet, dissipating energy by turbulent mixing and diffusion. The water level below each weir is generally lower than the weir crest and the weir resembles the classical free-flow case. Limited experimental results indicate that the discharge rating curve is similar to the one for sharp-crested weirs. In the streaming mode a surface jet with approximately uniform depth, d , flows over recirculating water in the pools. The turbulent shear stress between the surface jet and the recirculating mass in the pool dominates while side wall shear stress may be neglected. The dimensionless discharge for the plunging (Q_p) and streaming (Q_s) modes are given in Table 5.3a where B is the width of the weir. Maximum velocity in the plunging mode occurs near the top of the weir and decreases to about half at the water surface. In the streaming mode the average velocity in the jet is given as V in Table 5.3a.

Table 5.3a Weir fishways - dimensionless discharge equations for flow over the weir.

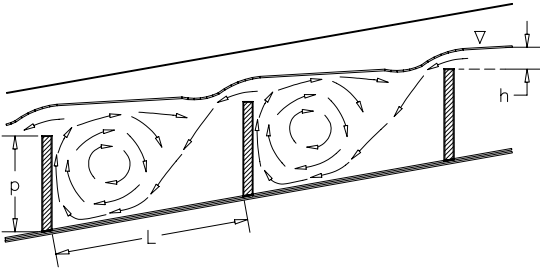
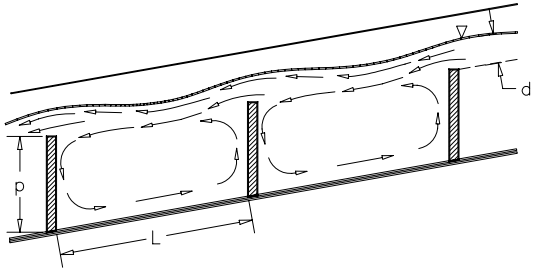
Plunging - Weir Flow	Streaming - Weir Flow
 $Q_p = \frac{Q_w}{Bh^{1.5}\sqrt{g}} = 0.61$ $u_m = \sqrt{2gh}$	 $Q_s = \frac{Q_w}{Bd^{1.5}\sqrt{gS_o}} = 1.5\sqrt{L/d}$ $V = \frac{Q_w}{Bd}$

The transition between plunging and streaming flow is characterized by acceleration over each weir crest, a standing wave below each weir, and a surface jet depth that varies cyclically along the fishway. The dimensionless discharge (Q_t) during the transition from plunging to streaming flow can be calculated using equation (5.7).

$$\text{Transitional - Weir Flow: } Q_t = \frac{Q_w}{BS_o L^{1.5} \sqrt{g}} = 0.25 \quad (5.7)$$

5.3.2 Orifice Flow

Orifices at each weir, close to the fishway bed, are frequently used. Fishway discharge for orifice flow may be analyzed as: a) a vertical slot for $y_o < z_o$, b) a submerged jet for $y_o > 2z_o$ and c) as an unsubmerged jet for in between depths where the orifice is submerged only on the upstream side. Table 5.3b summarizes dimensionless discharge (Q_d) rating curves for these cases with a standard pool and orifice configuration of $z_o = b_o$, $L = (6 \text{ to } 10) b_o$, $B = (5 \text{ to } 10) b_o$, $p = (3.5 \text{ to } 4) b_o$, with a small ($0.5b_o$ wide) deflecting baffle a short distance ($1.0b_o$) downstream of the orifice, similar to vertical slots.

Table 5.3b Weir fishways - dimensionless discharge equations for flow through the orifice.

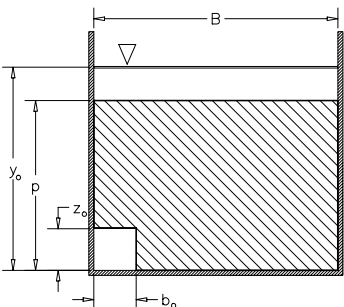
Orifice Flow	Water depth	$Q_j = \frac{Q_o}{\sqrt{gS_o b_o^5}}$	Flow
	$y_o < z_o$	$Q_j = 1.94 \left(\frac{y_o}{b_o} \right)$	vertical slot
	$y_o > 2z_o$	$Q_j = 2.25$	submerged jet

5.3.3 Weir & Orifice Flow

For a weir fishway with both weir and orifice flow, interaction between the hydraulic characteristics of the orifice and the weir can be neglected. The weir discharge (Q_w) can be calculated using the plunging, streaming, or transitional flow equations, and the orifice discharge (Q_o) is calculated using the dimensionless discharge equation for submerged jet flow ($Q_j=2.25$; Table 5.3b). The total discharge through the fishway is the sum of the weir and orifice discharges.

$$Q = Q_w + Q_o \quad (5.8)$$

5.4 Culvert Fishways

A culvert fishway (Fig. 2.4) consists of a sloping pipe flowing partly full with regularly spaced baffles or weirs on the bottom. Several baffle and weir arrangements were studied and are illustrated in Fig. 5.6.

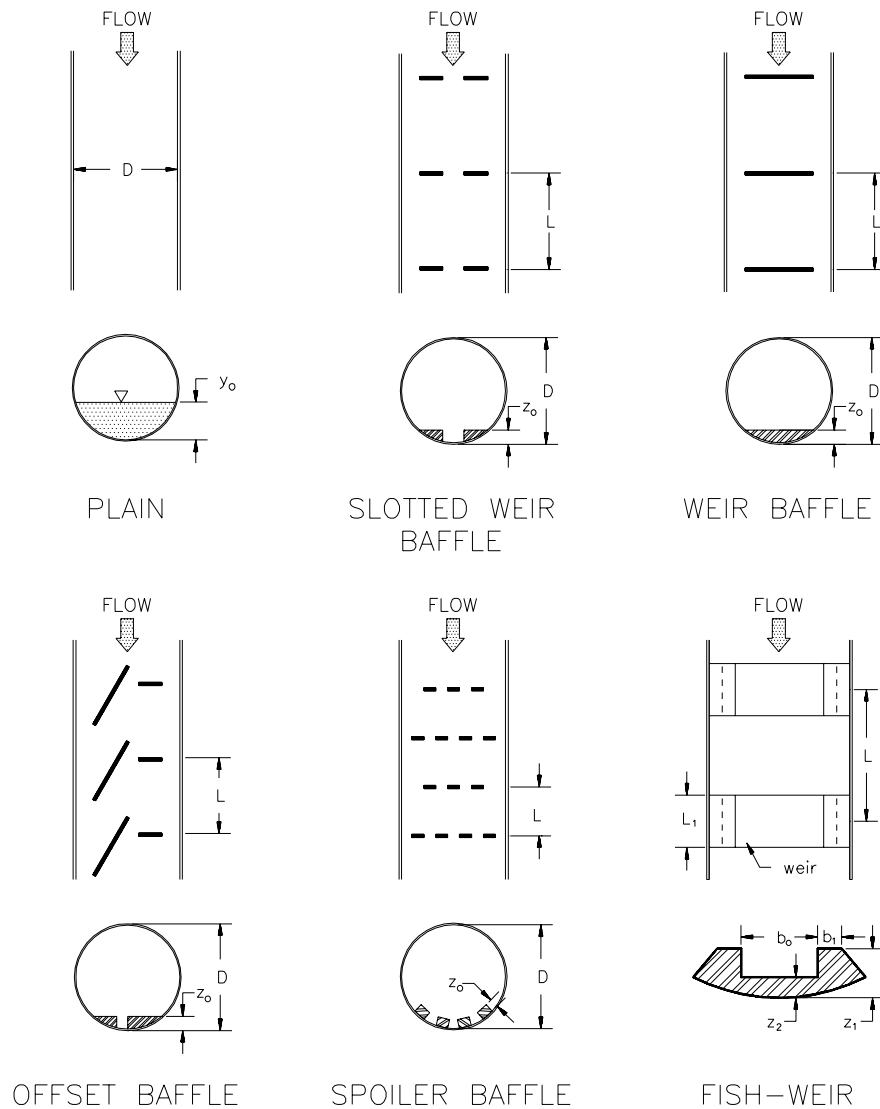

Figure 5.6 Culvert fishways - baffle and weir arrangements.

Flow analysis for culvert fishways is similar to weir fishways for depths higher than the baffle or weir height (z_0). Streaming flow occurs for all but the low depths, since z_0 is 0.1 to 0.15 of the

culvert diameter (D). Dimensionless discharge (Q_*) vs relative depth (y_o/D) takes the form of a power curve. Discharge rating curves and dimensionless velocity scales for the various designs are presented in sections 5.4.1 - 5.4.5.

$$Q_* = \frac{Q}{\sqrt{gS_oD^5}} = \alpha \left(\frac{y_o}{D} \right)^\beta \quad (5.10)$$

Velocity profiles at weirs or baffles were also evaluated for all the culvert fishways tested and analyzed by utilizing the profile similarity displayed.

$$U_* = \frac{u_m}{\sqrt{gS_oD}} = \alpha \left(\frac{y_o}{D} \right) + \beta \quad (5.11)$$

$$\frac{u}{u_m} = \alpha \left(\frac{y}{z_o} \right)^\beta \quad (5.12)$$

The flow characteristics at the inlet region of culverts flowing partly full were also studied. Closer baffle spacing may be needed when draw-down occurs.

5.4.1 Offset Baffle

Table 5.4 Offset baffle dimensionless discharge equations and velocity scales.

Design	L	z_o	y_o/D range	$Q_* = \frac{Q}{\sqrt{gS_oD^5}}$	y_o/D range	$U_* = \frac{u_m}{\sqrt{gS_oD}}$
D-1	0.67D	0.1D	0.029 - 0.565	$Q_* = 12(y_o/D)^{2.6}$	0.09 - 0.37	$U_* = 12.8(y_o/D)$
D-2	0.67D	0.2D	0.146 - 0.462	$Q_* = 11.14(y_o/D)^{3.63}$	0.22 - 0.42	$U_* = 5.6(y_o/D)$
D-3	0.33D	0.1D	0.076 - 0.469	$Q_* = 9.38(y_o/D)^{2.62}$	0.14 - 0.34	$U_* = 10.2(y_o/D)$
D-4	1.01D	0.10D	0.055 - 0.448	$Q_* = 9.48(y_o/D)^{2.57}$		

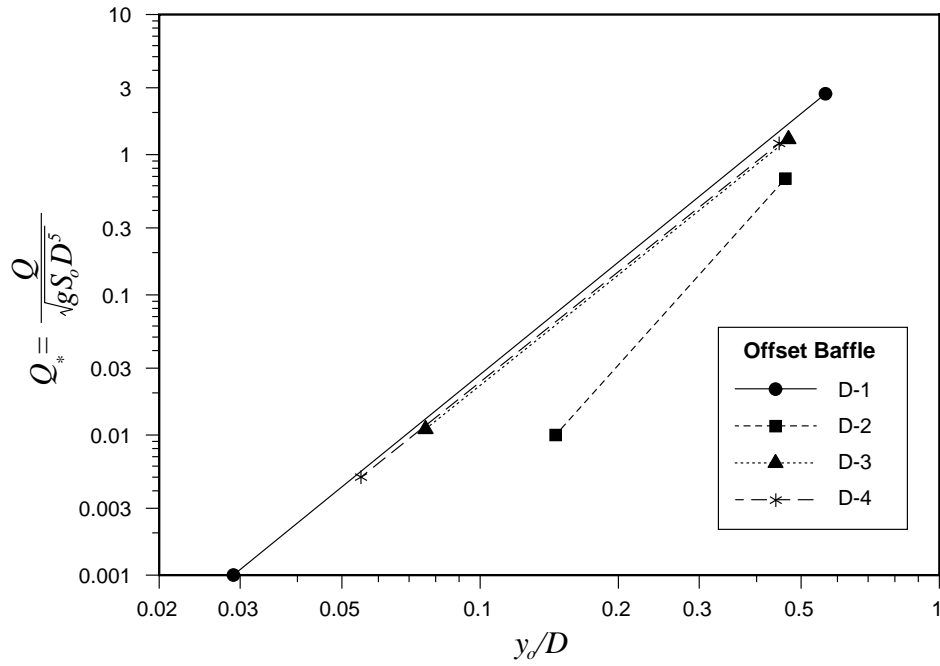

Figure 5.7 Offset baffle dimensionless discharge curves.

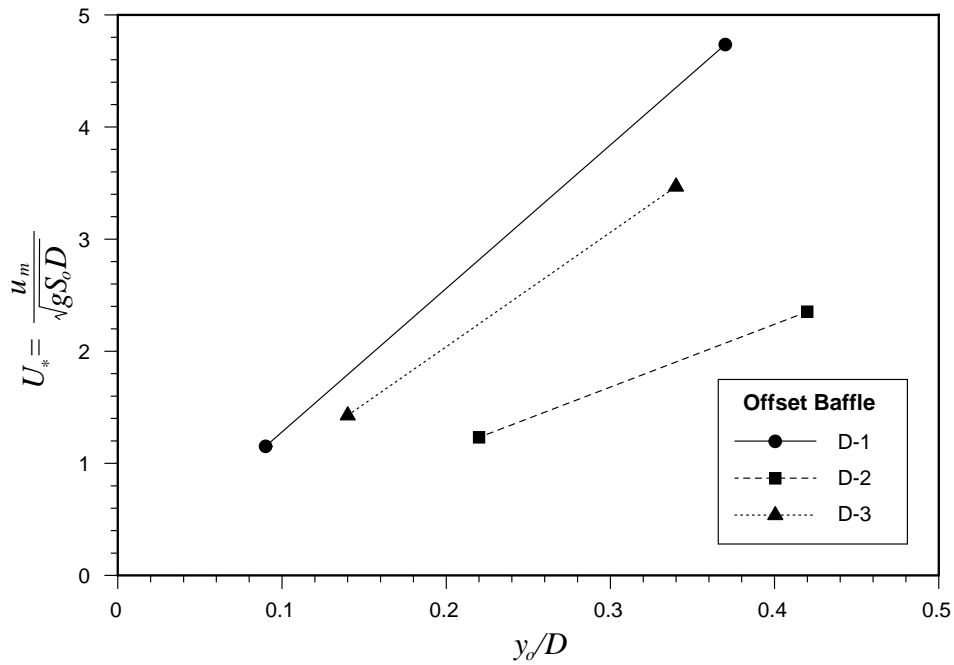

Figure 5.8 Offset baffle dimensionless velocity scales.

5.4.2 Weir Baffle

Table 5.5 Weir baffle dimensionless discharge equations and velocity scales.

Design	L	z_o	y_o/D range	$Q_* = \frac{Q}{\sqrt{gS_oD^5}}$	y_o/D range	$U_* = \frac{u_m}{\sqrt{gS_oD}}$
D-1	0.6D	0.15D	0.17 - 0.25 0.25 - 0.81	$Q_* = 549(y_o/D)^{5.78}$ $Q_* = 5.39(y_o/D)^{2.43}$	0.23 - 0.61	$U_* = 8.6(y_o/D)$
D-2	1.2D	0.15D	0.18 - 0.35 0.35 - 0.9	$Q_* = 35.3(y_o/D)^{4.14}$ $Q_* = 6.6(y_o/D)^{2.62}$	0.29 - 0.61	$U_* = 8.6(y_o/D)$
D-3	0.6D	0.1D	0.1 - 0.2 0.2 - 0.9	$Q_* = 443196(y_o/D)^{8.63}$ $Q_* = 8.62(y_o/D)^{2.53}$	0.24 - 0.53	$U_* = 10.9(y_o/D)$
D-4	1.2D	0.1D	0.2 - 0.9	$Q_* = 9(y_o/D)^{2.36}$		

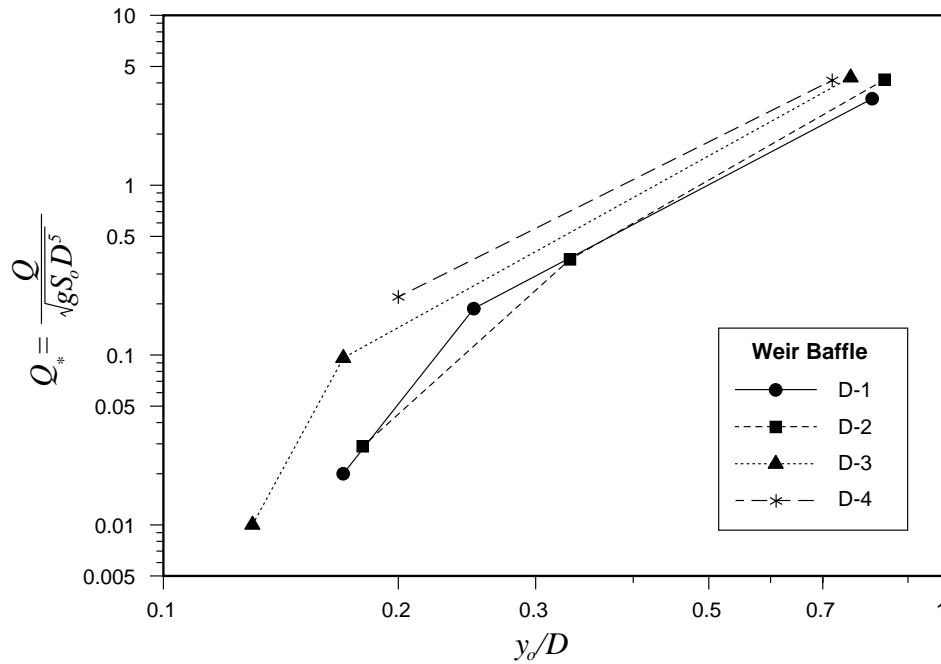

Figure 5.9 Weir baffle dimensionless discharge curves.

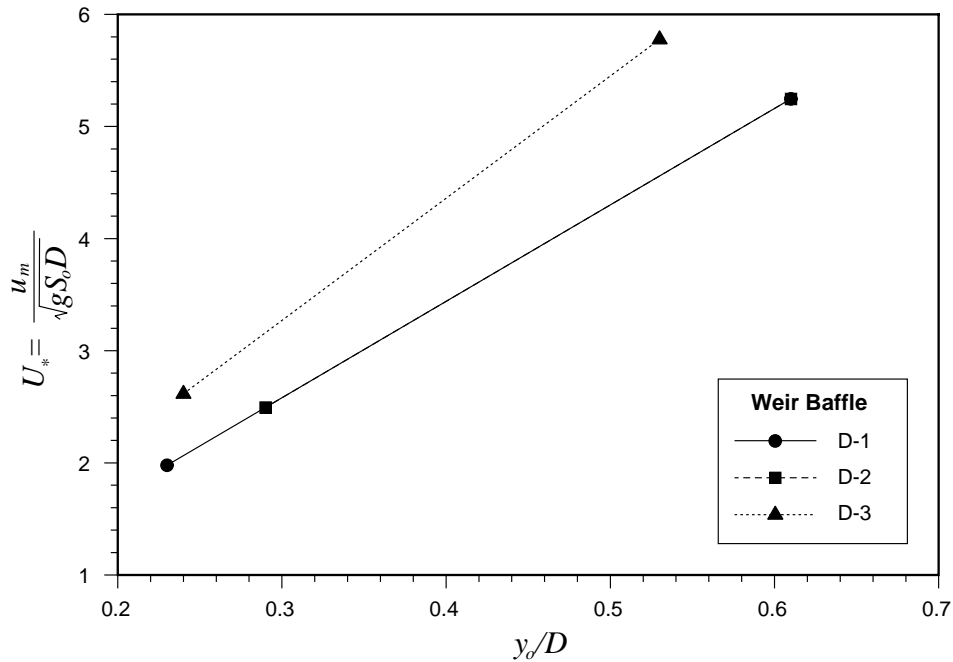

Figure 5.10 Weir baffle dimensionless velocity scales.

5.4.3 Slotted Weir Baffle

Table 5.6 Slotted weir baffle dimensionless discharge equations and velocity scales.

Design	L	z_o	y_o/D range	$Q_* = \frac{Q}{\sqrt{gS_oD^5}}$	y_o/D range	$U_* = \frac{u_m}{\sqrt{gS_oD}}$
D-1	0.6D	0.15D	0.12 - 0.85	$Q_* = 9.2(y_o/D)^{3.0}$	0.15 - 0.79	$U_* = 9.2(y_o/D)$
D-2	0.3D	0.15D	0.15 - 0.84	$Q_* = 9.2(y_o/D)^{3.0}$	0.18 - 0.78	$U_* = 9.2(y_o/D)$
D-3	1.2D	0.15D	0.14 - 0.76	$Q_* = 12.4(y_o/D)^{3.1}$	0.13 - 0.72	$U_* = 10.9(y_o/D)$
D-4	2.4D	0.15D	0.16 - 0.68	$Q_* = 13.8(y_o/D)^{3.1}$	0.14 - 0.67	$U_* = 12.7(y_o/D)$
D-5	0.6D	0.10D	0.10 - 0.73	$Q_* = 13.7(y_o/D)^{2.9}$	0.12 - 0.68	$U_* = 11.4(y_o/D)$
D-6	1.2D	0.10D	0.10 - 0.67	$Q_* = 14.9(y_o/D)^{3.0}$	0.13 - 0.68	$U_* = 12.4(y_o/D)$

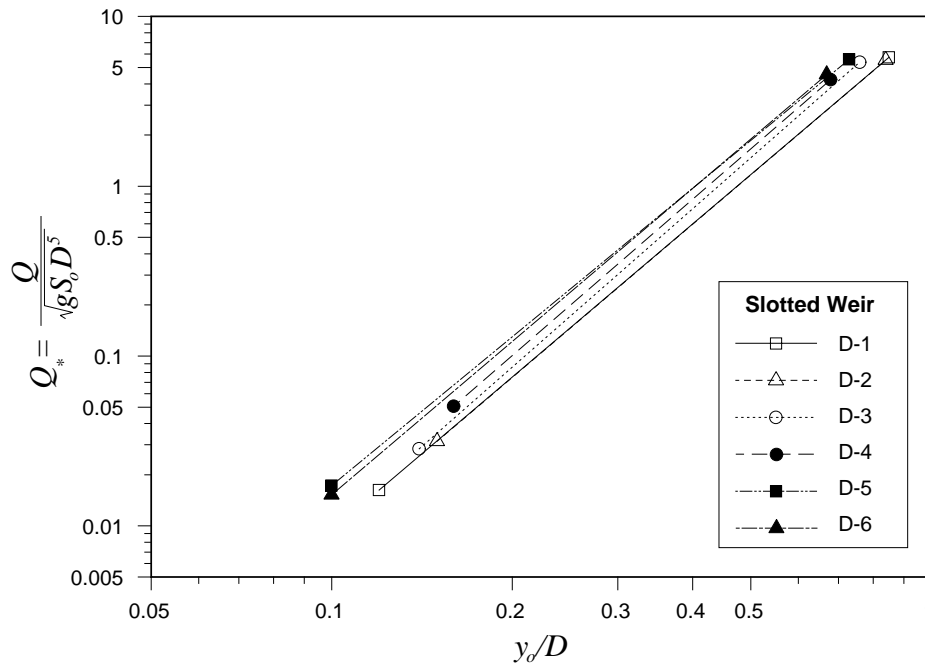

Figure 5.11 Slotted weir baffle dimensionless discharge curves.

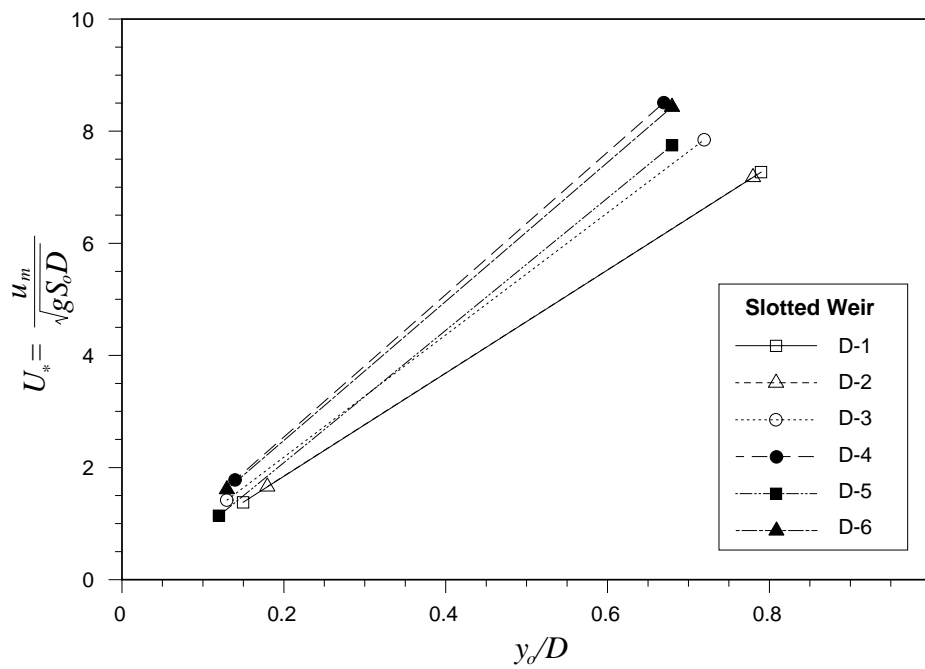

Figure 5.12 Slotted weir baffle dimensionless velocity scales.

5.4.4 Fish-Weir

For each design: $L_1 = 0.16 D$, $z_1 = 0.14D$, $z_2 = 0.06D$, $b_o = 0.22D$, $b_1 = 0.069D$ (see Fig. 5.6).

Table 5.7 Fish-weir dimensionless discharge equations and velocity scales.

Design	L	y_o/D range	$Q_* = \frac{Q}{\sqrt{gS_oD^5}}$	$U_* = \frac{u_m}{\sqrt{gS_oD}}$
D-1	2.39D	0.06 - 0.4	$Q_* = 17.63(y_o/D)^{2.88}$	$U_* = 4.8Q_*^{0.25}$
D-2	1.2D	0.09 - 0.4	$Q_* = 38.99(y_o/D)^{3.57}$	$U_* = 3.5Q_*^{0.25}$
D-3	0.6D	0.08 - 0.4	$Q_* = 21.2(y_o/D)^{3.2}$	$U_* = 3.5Q_*^{0.25}$
D-4	1.79D	0.045 - 0.4	$Q_* = 11.57(y_o/D)^{2.53}$	

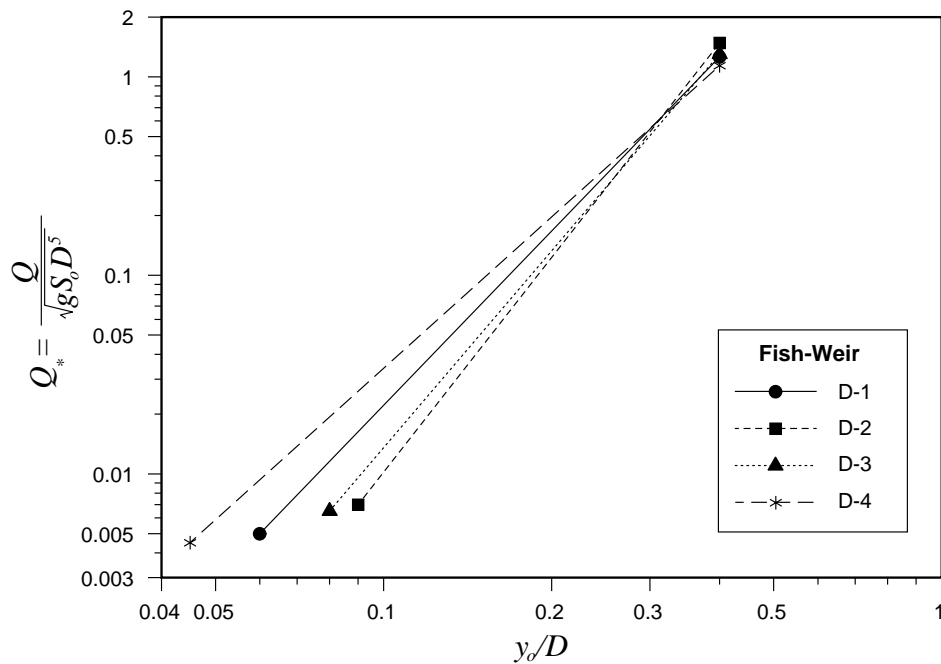

Figure 5.13 Fish-weir dimensionless discharge curves.

5.4.5 Spoiler Baffle

Table 5.8 Spoiler baffle dimensionless discharge equations and velocity scales.

Design	L	z_o	y_o/D range	$Q_* = \frac{Q}{\sqrt{gS_oD^3}}$	y_o/D range	$U_* = \frac{u_m}{\sqrt{gS_oD}}$
D-1	0.53D	0.09D	0.045 - 0.1 0.1 - 0.46	$Q_* = 0.85(y_o/D)^{2.02}$ $Q_* = 9.06(y_o/D)^{2.83}$	0.09 - 0.37	$U_* = 8.56(y_o/D)$
D-2	1.06D	0.09D	0.015 - 0.09 0.09 - 0.46	$Q_* = 0.29(y_o/D)^{1.12}$ $Q_* = 6.73(y_o/D)^{2.44}$	0.08 - 0.45	$U_* = 10.3(y_o/D)$
D-3	0.53D	0.15D	0.03 - 0.15 0.15 - 0.46	$Q_* = 0.33(y_o/D)^{1.35}$ $Q_* = 5.01(y_o/D)^{2.84}$	0.18 - 0.48	$U_* = 6.52(y_o/D)$
D-4	1.06D	0.15D	0.015 - 0.1 0.1 - 0.46	$Q_* = 0.19(y_o/D)^{0.98}$ $Q_* = 2.51(y_o/D)^{2.1}$		

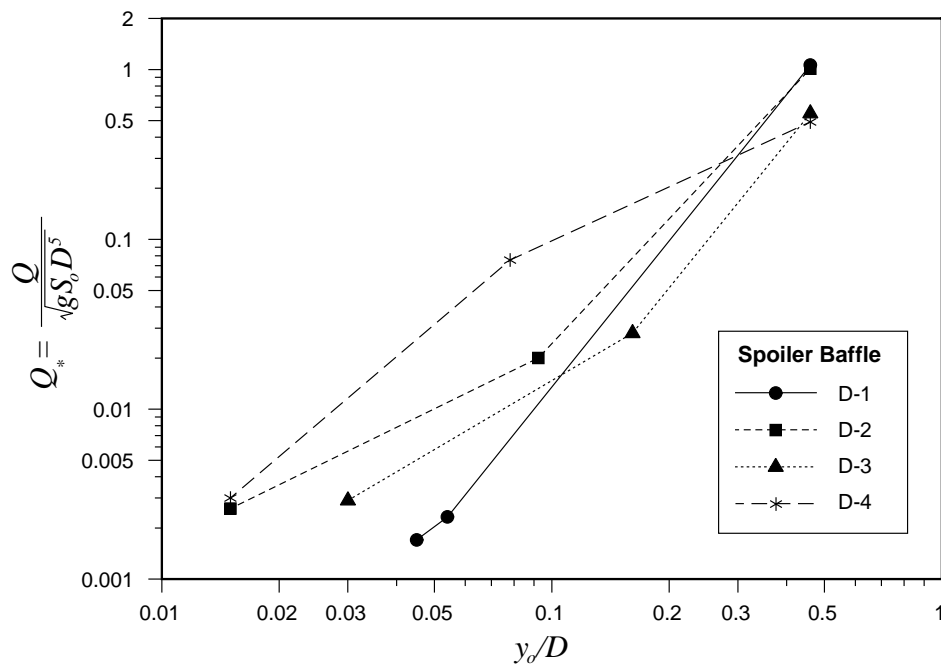

Figure 5.14 Spoiler baffle dimensionless discharge curves.

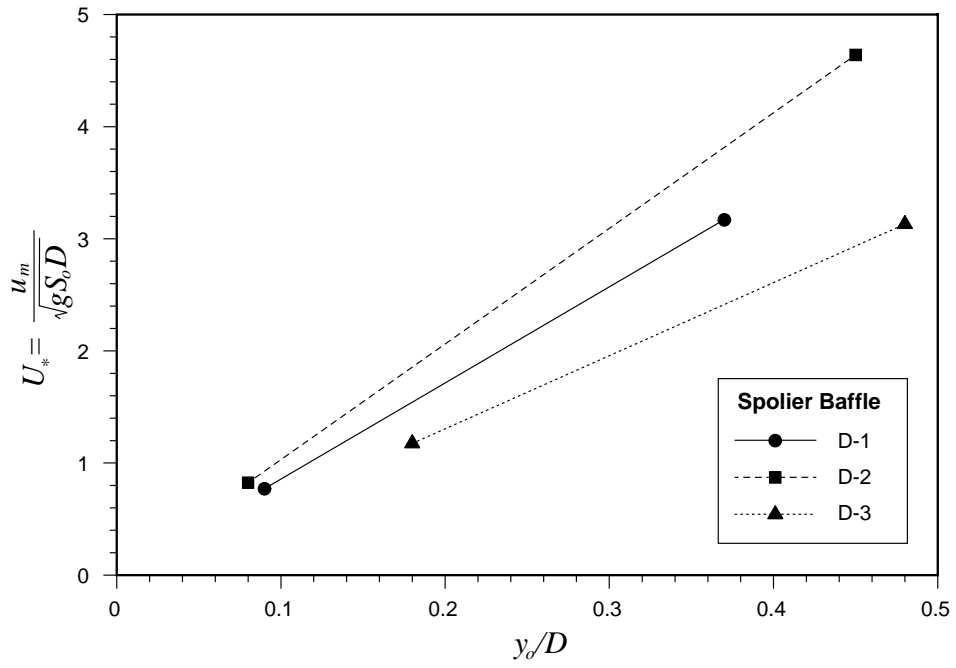

Figure 5.15 Spoiler baffle dimensionless velocity scales.

6 ICHTHYOMECHANICS

Fish locomotion and the mechanics of fish swimming, fish behaviour and motivation, fish responses to natural and artificial stimuli, are all critical to the development of fish protection technology in general and to fishway design in particular. Despite a growing data base, significant gains in knowledge and better understanding of fish biomechanics, specific information on how long (endurance time) or how far (swimming distance) a particular fish can swim against a given water velocity, is limited or simply not available for many fish species. In an attempt to address this deficiency, literature on fish swimming performance tests was compiled (over 500 references) and reported data were entered into a computer database. The database consists of author and date, genera, species, test method, water temperature, number of fish tested, life stage, fish length (l), swimming speed (U), and endurance time (t). Although large data gaps for most species exist, the database can be consulted for specific information.

Analyses with dimensionless variables indicate similarity in the swimming performance of several fish species. Most fish swim with undulatory motions by passing alternating waves of contraction backward along the body muscles. Most of the data gathered involve fish swimming in the subcarangiform and anguilliform modes. Subcarangiform is an undulatory mode of swimming characterized by small side-to-side amplitude at the anterior and large amplitude only in the posterior half or one-third of the body. The characteristic body shape is fusiform, the caudal peduncle is fairly deep and the caudal fin has a rather low aspect ratio. In the anguilliform mode most or all of the length of the body participates in propulsion. The body is long and thin, the anterior cylindrical, the posterior compressed and caudal fin is usually small. Similar hydrodynamic analysis may be applicable to fish swimming in the same mode, regardless of phyletic origin. Figure 6.1 presents the data available in the database using dimensionless variables for species swimming in the subcarangiform and anguilliform modes. Figure 6.1 indicates that for each swimming mode data tend to collapse within a relatively small region of the graph even though diverse species, data sources, and test methods are involved in the subcarangiform mode. In the burst speed range ($t \leq 20$ s) points from both swimming modes are well represented by a single line. In the prolonged speed range ($20\text{ s} < t \leq 30$ min) the anguilliform mode is well represented by the same line, while the slope of the line for the subcarangiform mode is significantly milder, indicating higher endurance for these species. The inferred relationship between the dimensionless fish speed F_f and the dimensionless endurance t_* is of the form:

$$F_f = Kt_*^{-\eta} \quad (6.1)$$

For the subcarangiform mode the species involved include: a) 10 anadromous species: Arctic charr (*Salvelinus alpinus*), Atlantic salmon (*Salmo salar*), brook trout (*Salvelinus fontinalis*), chum salmon (*Oncorhynchus keta*), cisco (*Coregonus artedii*), coho salmon (*Oncorhynchus kisutch*), humpback whitefish (*Coregonus clupeaformis*), pink salmon (*Oncorhynchus gorbuscha*), rainbow trout (*Oncorhynchus mykiss*; formerly *Salmo gairdneri*), sockeye salmon (*Oncorhynchus nerka*), b) 10 freshwater species: Arctic grayling (*Thymallus arcticus*), dace (*Leuciscus leuciscus*), flathead chub (*Platygobio gracilus*), goldfish (*Carassius auratus*), humpback whitefish (*Coregonus*

clupeaformis), largemouth bass, (*Micropterus salmoides*) longnose sucker (*Catostomus catostomus*), rainbow trout (*Oncorhynchus mykiss*; formerly *Salmo irideus*), walleye (*Stizostedion vitreum*), white sucker (*Catostomus commersoni*). The anguilliform mode includes two species, lamprey (*Petromyzon marinus*) and burbot (*Lota lota*). Data in this analysis were restricted to temperatures which did not appear to affect swimming performance.

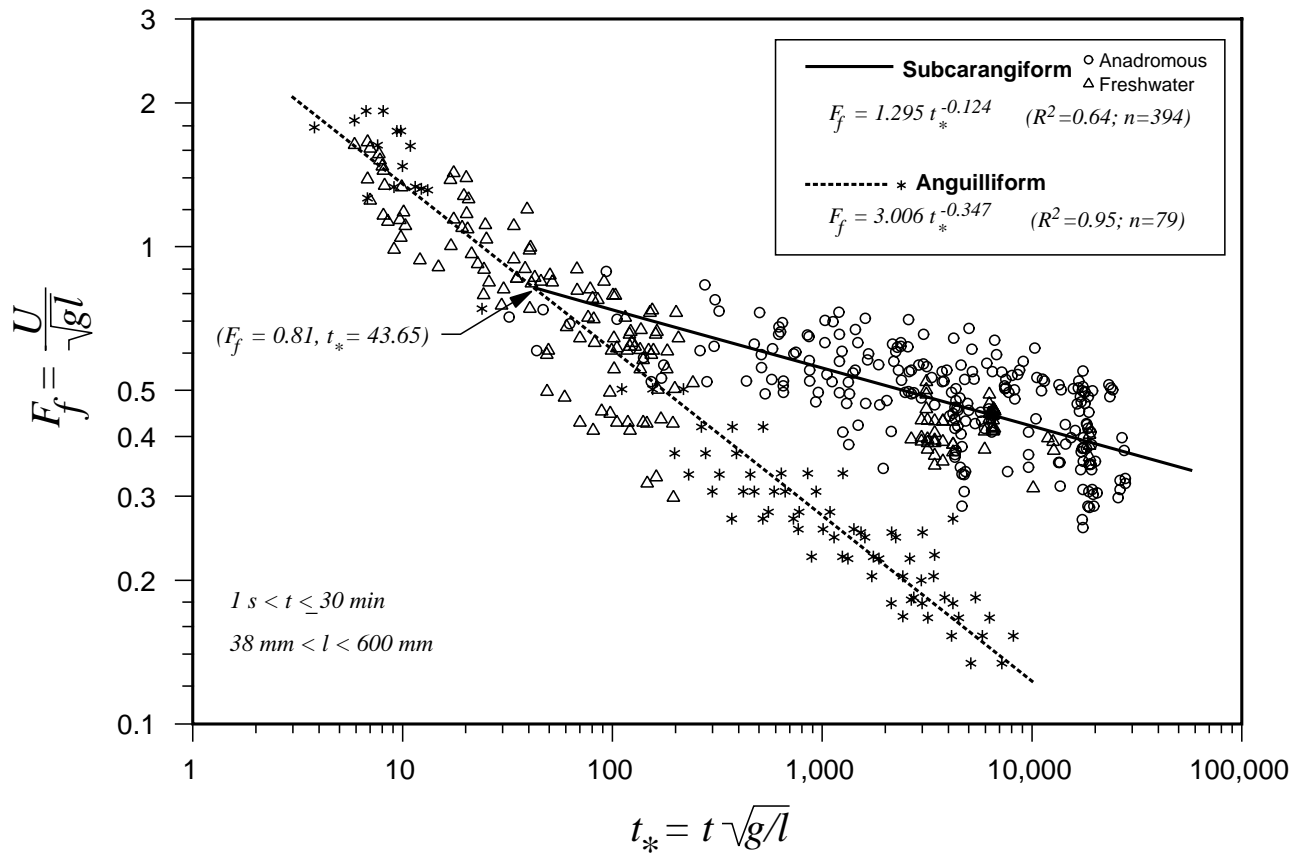

Figure 6.1 Fish endurance curves.

Figure 6.1 provides a guide to swimming speeds of several fish particularly when endurance time is of primary concern. This relationship can also be transformed into a water velocity vs swimming distance relationship. Considering the distance, X , that a fish travels by maintaining a speed, U , for a time (endurance), t , against water velocity, V , the following relationship is assumed:

$$X = (U - V)t \quad (6.2)$$

As can be seen from Figure 6.2 the swimming distance (X) is represented by the shaded area on a velocity vs time graph.

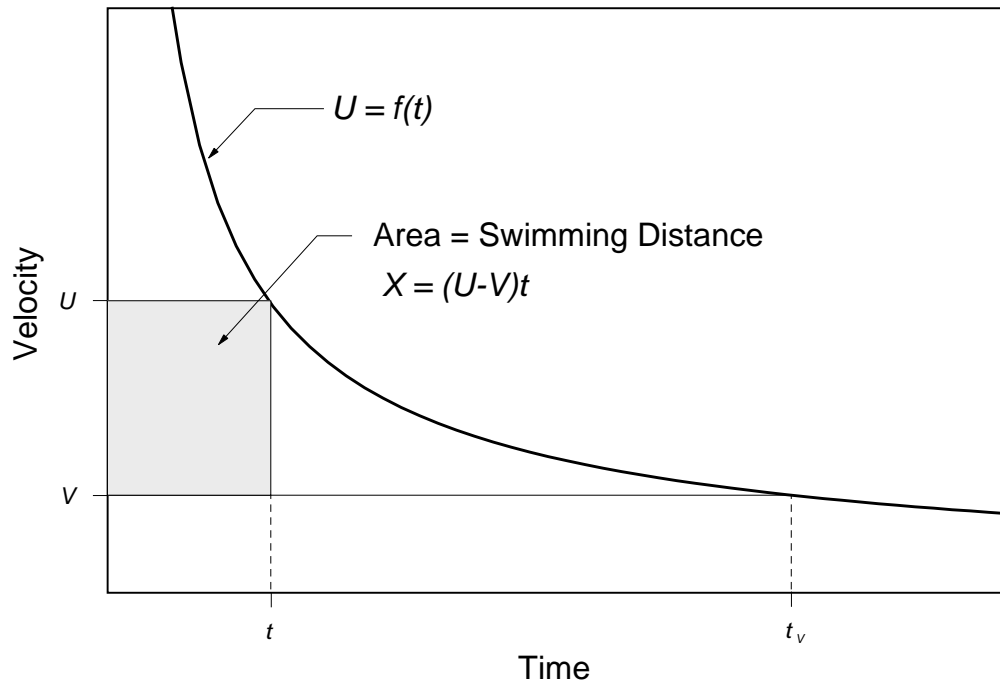

Figure 6.2 Swimming distance based on $X = (U - V)t$.

where: X = swimming distance,
 U = fish swimming speed,
 V = water velocity,
 t = endurance time.

Substituting between (6.1) and (6.2) and maximizing X , results in the following functional relationship:

$$\xi = CF^{-\lambda} \quad (6.3)$$

$$\text{where: } \xi = X_{\max}/l; \quad F = V/\sqrt{gl}; \quad \lambda = (1 - \eta)/\eta; \quad C = \eta(1 - \eta)^\lambda K^{1/\eta} \quad (6.4)$$

Figure 6.3 illustrates equation (6.3) while Figs. 6.4 and 6.5 are derived from (6.3) once specific water velocities and fish lengths are applied. Table 6.1 summarizes the range of data for the species and variables used in the analysis. Table 6.2 provides a list of fish species and their swimming modes, while Table 6.3 summarizes regression equations for swimming speed vs fish length for several species reported in the literature.

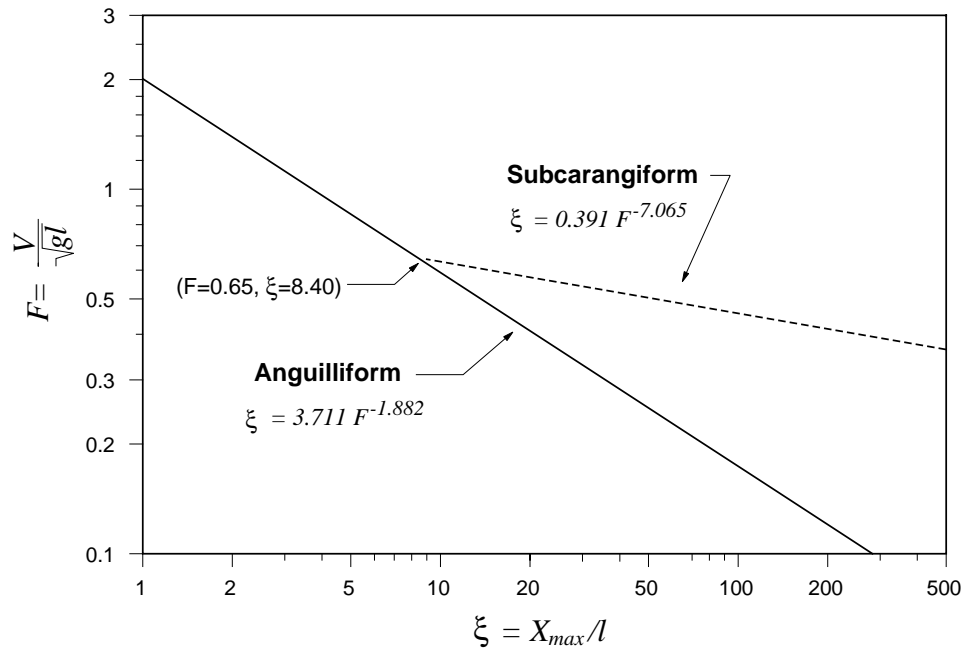

Figure 6.3 Dimensionless swimming distance curves.

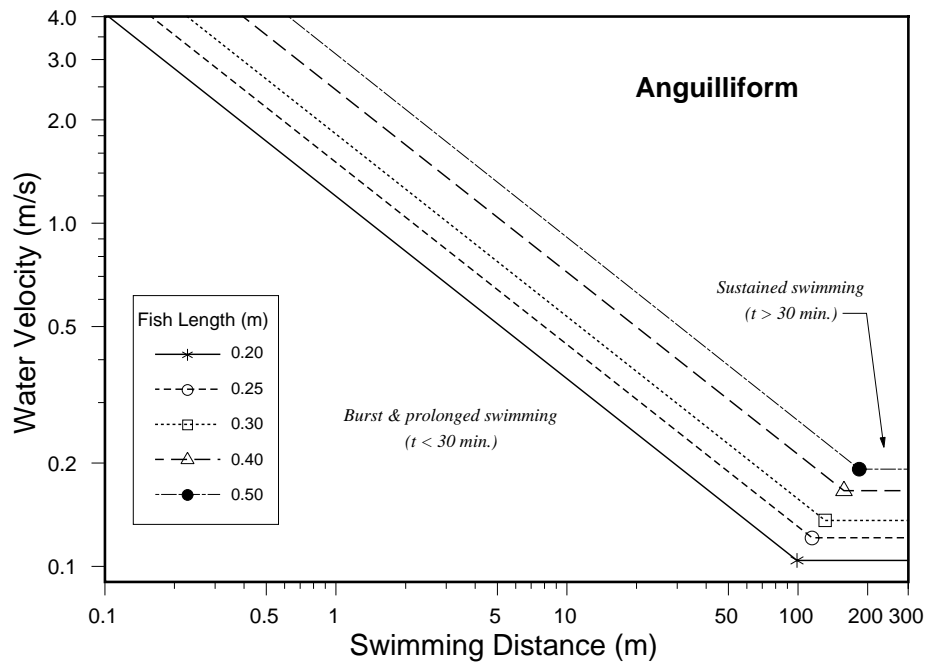

Figure 6.4 Swimming distance curves for several fish lengths (Anguilliform mode).

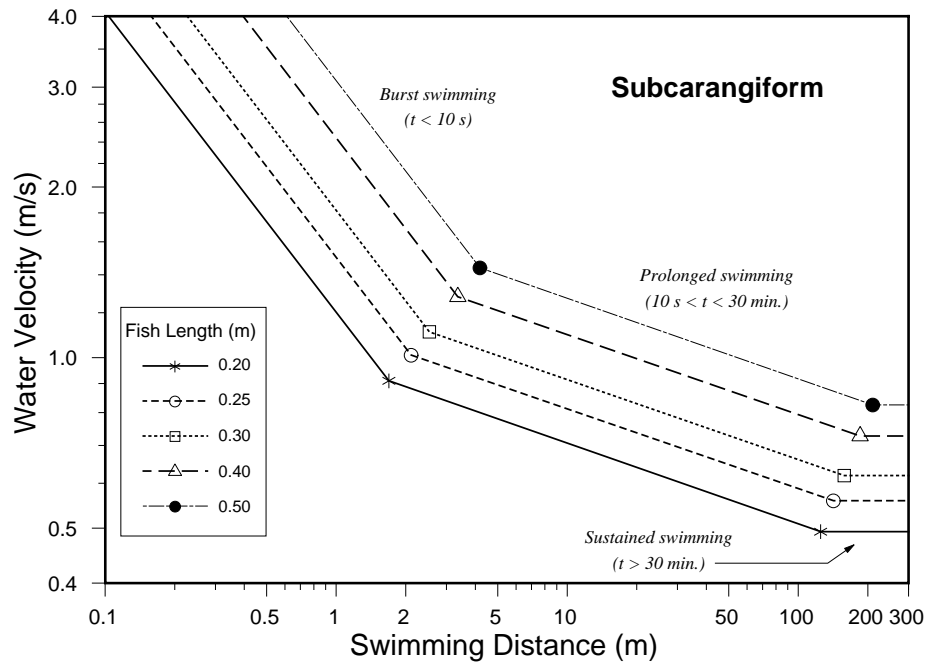

Figure 6.5 Swimming distance curves for several fish lengths (Subcarangiform mode).

Table 6.1 Variables and ranges of swimming performance data used in analysis

Common Name	Scientific Name	Length Range (mm)	Endurance Time (s)	Swimming Speed (m/s)	Temp. (°C)	No. of Fish	No. of Sources
Anguilliform Swimming Mode							
Burbot	<i>Lota lota</i>	120 - 620	600	0.360 - 0.410	7 - 12	56	1
Lamprey	<i>Petromyzon marinus</i>	145 - 508	0.8 - 1635	0.300 - 3.960	5 - 23	>75	2
Subcarangiform Swimming Mode							
Arctic char	<i>Salvelinus alpinus</i> ^A	80 - 420	6 - 1089	0.411 - 1.300	10 - 13.5	64	3
Arctic grayling	<i>Thymallus arcticus</i> ^F	70 - 370	600	0.520 - 0.720	12 - 19	94	1
Atlantic salmon	<i>Salmo salar</i> ^A	231	300	0.516	7.0	55	1
Brook trout	<i>Salvelinus fontinalis</i> ^A	41 - 172	10 - 1800	0.202 - 0.930	11.5 - 15	42	3
Chum salmon	<i>Oncorhynchus keta</i> ^A	38 - 48	300	0.181 - 0.342	10	17	1
Cisco	<i>Coregonus artedii</i> ^A	135	433 - 1800	0.458 - 0.630	12	20	1
Coho salmon	<i>Oncorhynchus kisutch</i> ^A	51 - 133	534 - 1746	0.343 - 0.701	10 - 20	>100	2
Dace	<i>Leuciscus leuciscus</i> ^F	100 - 200	1 - 20	0.430 - 2.400	15	7	1
Flathead chub	<i>Platygobio gracilis</i> ^F	170 - 300	600	0.429 - 0.627	12 - 19	28	1
Goldfish	<i>Carassius auratus</i> ^F	67 - 213	1 - 20	0.420 - 2.000	15	8	1
Humpback whitefish	<i>Coregonus clupeaformis</i> ^{A/F}	60 - 510	72 - 1278	0.341 - 1.021	5 - 19	>200	2
Largemouth bass	<i>Micropterus salmoides</i> ^F	81 - 224	300 - 1800	0.340 - 0.589	20 - 30	190	3
Longnose sucker	<i>Catostomus catostomus</i> ^F	40 - 530	600	0.230 - 0.910	7 - 19	169	1
Pink salmon	<i>Oncorhynchus gorbuscha</i> ^A	465 - 596	72 - 1278	0.780 - 1.740	12 - 20	212	2
Rainbow trout ¹	<i>Oncorhynchus mykiss</i> ^{A/F}	82 - 310	1 - 1800	0.257 - 2.700	7 - 15	78	4
Sockeye salmon	<i>Oncorhynchus nerka</i> ^A	126 - 621	6 - 1350	0.554 - 1.700	10 - 18	47	3
Walleye	<i>Stizostedion vitreum</i> ^F	80 - 380	600	0.380 - 0.840	19	54	1
White sucker	<i>Catostomus commersoni</i> ^F	170 - 370	600	0.480 - 0.730	12 - 19	20	1

¹ Former scientific names: *Salmo gairdneri*; *Salmo irideus*.

A - Anadromous, F - Freshwater

Table 6.2 Summary of species and swimming modes; all species from Osteichthyes class except lamprey which are from the Agnatha class.

Common Name	Scientific Name	Family / Subfamily	Order	Swimming Mode
Alewife	<i>Alosa pseudoharengus</i>	Clupeidae	Clupeiformes	Subcarangiform
Arctic charr	<i>Salvelinus alpinus</i>	Salmonidae / Salmoninae	Salmoniformes	Subcarangiform
Arctic grayling	<i>Thymallus arcticus</i>	Salmonidae / Thymalinae	Salmoniformes	Subcarangiform
Atlantic salmon	<i>Salmo salar</i>	Salmonidae / Salmoninae	Salmoniformes	Subcarangiform
Bonytail chub	<i>Gila elegans</i>	Cyprinidae	Cypriniformes	Subcarangiform
Broad whitefish	<i>Coregonus nasus</i>	Salmonidae / Coregoninae	Salmoniformes	Subcarangiform
Brook trout	<i>Salvelinus fontinalis</i>	Salmonidae / Salmoninae	Salmoniformes	Subcarangiform
Burbot	<i>Lota lota</i>	Gadidae	Gadiformes	Anguilliform
Carp	<i>Cyprinus carpio</i>	Cyprinidae	Cypriniformes	Subcarangiform
Chinook salmon	<i>Oncorhynchus tshawytscha</i>	Salmonidae / Salmoninae	Salmoniformes	Subcarangiform
Chum salmon	<i>Oncorhynchus keta</i>	Salmonidae / Salmoninae	Salmoniformes	Subcarangiform
Cisco	<i>Coregonus artedii</i>	Salmonidae / Salmoninae	Salmoniformes	Subcarangiform
Coho salmon	<i>Oncorhynchus kisutch</i>	Salmonidae / Salmoninae	Salmoniformes	Subcarangiform
Colorado squawfish	<i>Ptychocheilus lucius</i>	Cyprinidae	Cypriniformes	Subcarangiform
Dace	<i>Leuciscus leuciscus</i>	Cyprinidae	Cypriniformes	Subcarangiform
Flathead chub	<i>Platygobio gracilis</i>	Cyprinidae	Cypriniformes	Subcarangiform
Goldfish	<i>Carassius auratus</i>	Cyprinidae	Cypriniformes	Subcarangiform
Humpback chub	<i>Gila cypha</i>	Cyprinidae	Cypriniformes	Subcarangiform
Humpback whitefish	<i>Coregonus clupeaformis</i>	Salmonidae / Coregoninae	Salmoniformes	Subcarangiform
Inconnu	<i>Stenodus leucichthys</i>	Salmonidae	Salmoniformes	Subcarangiform
Lake sturgeon	<i>Acipenser fulvescens</i>	Acipenseridae	Acipenseriformes	Subcarangiform/Carangiform
Lake trout	<i>Salvelinus namaycush</i>	Salmonidae	Salmoniformes	Subcarangiform
Lamprey	<i>Petromyzon marinus</i>	Petromyzontidae	Petromyzontiformes	Anguilliform
Largemouth bass	<i>Micropterus salmoides</i>	Centrarchidae	Perciformes	Subcarangiform
Longnose sucker	<i>Catostomus catostomus</i>	Catostomidae	Cypriniformes	Subcarangiform
Northern pike	<i>Esox lucius</i>	Esocidae	Salmoniformes	Subcarangiform/Labriform ¹
Pink salmon	<i>Oncorhynchus gorbuscha</i>	Salmonidae / Salmoninae	Salmoniformes	Subcarangiform
Rainbow smelt	<i>Osmerus mordax</i>	Osmeridae	Perciformes	Subcarangiform
Rainbow trout	<i>Oncorhynchus mykiss</i> ²	Salmonidae / Salmoninae	Salmoniformes	Subcarangiform
Sockeye salmon	<i>Oncorhynchus nerka</i>	Salmonidae / Salmoninae	Salmoniformes	Subcarangiform
Threespine stickleback	<i>Gasterosteus aculeatus</i>	Gasterosteidae	Gasterosteiformes	Diodontiform/Ostraciform
Walleye	<i>Stizostedion vitreum</i>	Percidae	Perciformes	Subcarangiform
White perch	<i>Morone americana</i>	Percichthyidae	Perciformes	Subcarangiform/Carangiform
White sucker	<i>Catostomus commersoni</i>	Catostomidae	Cypriniformes	Subcarangiform
Yellow perch	<i>Perca flavescens</i>	Percidae	Perciformes	Subcarangiform

¹ Labriform swimming mode as a predator.

² Former scientific name *Salmo gairdneri*.

Table 6.3 Fish swimming performance data - regression equations. Note: all data are from increasing velocity tests.

Scientific Name	Common Name	Temp. T(°C)	Length Range l (m)	LM ¹	F/A ²	Time t (s)	# ³	Regression Equation	Reference
<i>Alosa pseudoharengus</i>	Alewife	15	0.046 - 0.150	FL	FW	3600	31	$U = 0.771 L^{0.193}$	Griffiths (1979)
<i>Catostomus catostomus</i>	Longnose sucker	13	0.040 - 0.530	FL	FW	600	179	$U = 1.261 L^{0.529}$	Jones et al (1973)
<i>Catostomus commersoni</i>	White sucker	16	0.170 - 0.370	FL	FW	600	20	$U = 1.309 L^{0.552}$	Jones et al (1973)
<i>Coregonus clupeaformis</i>	Humpback whitefish	13	0.060 - 0.510	FL	FW	600	168	$U = 0.912 L^{0.350}$	Jones et al (1973)
<i>Coregonus nasus</i>	Broad whitefish	12.5	0.060 - 0.330	FL	FW	600	24	$U = 0.770 L^{0.450}$	Jones et al (1973)
<i>Esox lucius</i>	Northern pike	13	0.120 - 0.620	FL	FW	600	192	$U = 0.617 L^{0.550}$	Jones et al (1973)
<i>Micropterus salmoides</i>	Largemouth bass	10	0.216	TL	FW	1800	15	$U = 0.086 * 1072^L$	Beamish (1970)
		15	0.225	TL	FW	1800	15	$U = 0.161 * 125.9^L$	
		20	0.197	TL	FW	1800	15	$U = 0.280 * 23.44^L$	
		25	0.200	TL	FW	1800	15	$U = 0.318 * 14.79^L$	
		30	0.224	TL	FW	1800	15	$U = 0.317 * 15.85^L$	
		34	0.212	TL	FW	1800	15	$U = 0.249 * 24.55^L$	
<i>Morone americana</i>	White perch	10	0.076 - 0.248	FL	FW	3600	52	$U = 0.897 L^{0.333}$	Griffiths (1979)
<i>Lota lota</i>	Burbot	13	0.120 - 0.620	FL	FW	600	53	$U = 0.442 L^{0.070}$	Jones et al (1973)
<i>Oncorhynchus nerka</i>	Sockeye salmon	2	0.092	TL	AN	3600	?	$U = 1.459 L^{0.6294}$	Brett & Glass (1973)
		5	0.092	TL	AN	3600	?	$U = 1.600 L^{0.6243}$	
		10	0.092	TL	AN	3600	?	$U = 1.965 L^{0.6294}$	
		15	0.092	TL	AN	3600	?	$U = 2.500 L^{0.6345}$	
		20	0.092	TL	AN	3600	?	$U = 2.300 L^{0.6293}$	
<i>Osmerus mordax</i>	Rainbow smelt	10	0.070 - 0.163	FL	FW	3600	31	$U = 1.148 L^{0.504}$	Griffiths (1979)
<i>Perca flavescens</i>	Yellow perch	10	0.096 - 0.245	FL	FW	3600	55	$U = 0.703 L^{0.307}$	Griffiths (1979)
		20	0.096 - 0.245	FL	FW	3600	60	$U = 0.579 L^{0.114}$	
<i>Platygobio gracilis</i>	Flathead chub	16	0.170 - 0.300	FL	FW	600	28	$U = 1.450 L^{0.670}$	Jones et al (1973)
<i>Salmo salar</i>	Atlantic salmon	7-12	0.197 - 0.256	TL	AN	300	55	$U = 0.173 + 1.57 L$	McCleave & Stred (1975)
<i>Salvelinus alpinus</i>	Arctic charr	10	0.080 - 0.420	FL	AN	600	26	$U = 1.660 L^{0.606}$	Welch (1979)
<i>Stenodus leucichthys</i>	Inconnu	16	0.080 - 0.410	FL	FW	600	22	$U = 0.678 L^{0.175}$	Jones et al (1973)
<i>Stizostedion vitreum</i>	Walleye	16	0.040 - 0.500	FL	FW	600	54	$U = 1.369 L^{0.510}$	Jones et al (1973)
<i>Thymallus arcticus</i>	Arctic grayling	13	0.070 - 0.370	FL	FW	600	105	$U = 0.880 L^{0.193}$	Jones et al (1973)

1 Length measurement: FL=fork length, TL=total length. 2 FW=freshwater, AN=anadromous. 3 Number of fish tested.

7 FISHWAY EFFECTIVENESS

7.1 General

There is a large body of literature documenting the successes and failures of fishway installations around the world. Generally, fish passage effectiveness varies with fishway design practice, species and site conditions. Fishways for the highly motivated salmon spawners are commonly successful, several design options are available, and numerous facilities exist as examples. Fishways for other species and juvenile fish are more recent and not as well documented. In the last decade several fishways were monitored in the Canadian provinces of Alberta, Saskatchewan, Manitoba and Ontario (Fig. 7.1). These fishways were used mostly by spawning fish which migrate entirely within a freshwater system of rivers and lakes.



Figure 7.1 Location of some fishways for freshwater species which have been monitored.

Field studies have provided assessments of several Denil, vertical slot, weir and culvert fishways. Difficulties with some installations, particularly poorly designed weir fishways were overcome. Adult species which used such fishways include Arctic grayling, mountain whitefish (*Prosopium williamsoni*), lake whitefish (*Coregonus clupeaformis*), cisco (*Coregonus artedii*), northern pike, walleye, sauger (*Stizostedion canadense*), yellow perch (*Perca flavescens*), trout-perch (*Percopsis omiscomaycus*), white sucker, longnose sucker, carp (*Cyprinus carpio*), and burbot. Juveniles of some of the above species as well as spottail shiners (*Notropis hudsonius*) have also been reported using fishways. Several Liard Highway culverts were constructed using the stream simulation approach. At four of these the performance of culvert fish passage was assessed. This field study indicated that the culverts presented no difficulty to the spring migrations of Arctic grayling, longnose sucker and northern pike. Culvert velocities were comparable to the natural stream and no spawning migration delays were apparent. The presence of riprap, at least on one occasion, assisted the establishment of flow under the culvert ice and allowed fish to pass through the culvert without delay. With stream simulation, culvert construction has the potential for preserving or enhancing fish habitat since gravel, placed or deposited naturally in the culvert, may provide habitat suitable for fish spawning.

7.2 Assessment of Denil Fishways for freshwater species

Fish movements through Denil fishways in the Grand River Weir near Freeport, Ontario, the Fairford Dam near Fairford, Manitoba and the Cowan Dam in Saskatchewan were assessed using traps at the fish exit (upstream end) of each facility. The Freeport fishways were assessed daily from April 20 to May 11, 1990, the Fairford fishway was assessed daily from May 6-28 and June 2-12, 1987; and the Cowan fishway was assessed daily from April 27 to May 11, 1985, and weekly thereafter until June 10, 1985. At Cowan and Fairford the trap was lifted and emptied at least three times per day; in the morning, afternoon and evening. At Freeport the trap's were lifted and emptied twice per day. The data collected during the assessment program consisted of counting and identifying all of the species captured in the traps, as well as determining the fork lengths and other biological data (sex, spawning condition, weight) for key species. Water levels upstream, downstream and throughout each fishway were recorded as well as water temperatures.

The Fairford and Cowan plain Denil fishways have a similar layout, consisting of three flumes equipped with planar baffles, two resting pools and two vertical lift control gates (Fig. 7.2). The Grand River Weir at Freeport contains two plain Denil fishways with identical cross-sectional dimensions. The east bank fishway consists of a single flume at a 20% slope, the west bank fishway consists of three flumes each at a 10% slope and two resting pools. Figure 7.2 shows an isometric and plan view of the Fairford fishway as well as the plan views of the east and west bank fishways at Freeport. The plan view of the Cowan fishway is a mirror image of the Fairford fishway. Table 7.1 lists the dimensions for each fishway. The control gates at the outlet of each fishway allow for the operation of either all three fishway flumes when tailwater is low, or only the upper flume when tailwater is high.

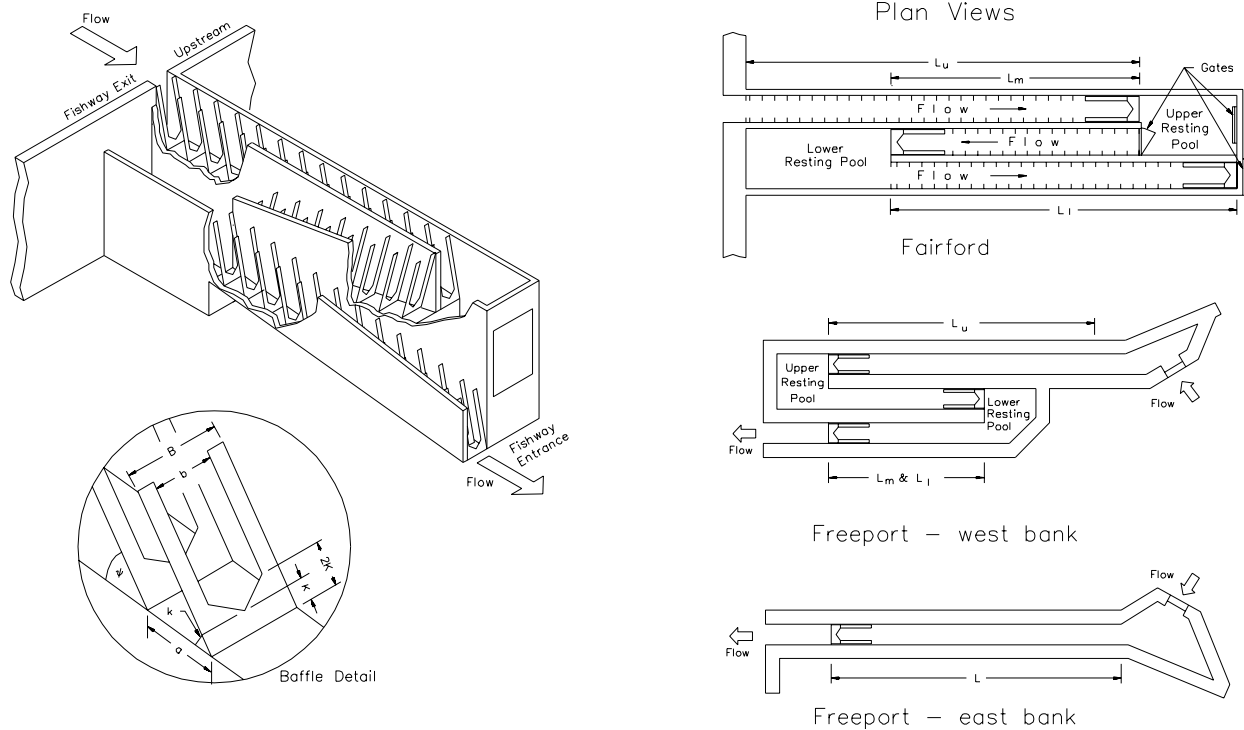

Figure 7.2 Isometric and plan views of Denil fishways at Fairford and Freeport.

Table 7.1 Dimensions of the Freeport, Fairford and Cowan fishways. Symbols are defined in Figure 7.2.

Dimensions	Fairford	Cowan	Freeport	
B (mm)	500	634	596	
b (mm)	300	400	360	
a (mm)	300	300	250	
k (mm)	88.4	106.1	127.3	
K (mm)	125	150	180	
ψ	45 ^o	45 ^o	45 ^o	
Total drop (m)	2.9	2.20	1.67	
Fishway Section (upper, middle, lower)				
			West fishway	East fishway
Length (L, m)	6.3, 5.0, 6.6	9.5, 6.0, 8.5	7.7, 4.5, 4.5	8.4
Slope (S, %)	12.9, 12.8, 12.6	12.6, 10.0, 10.0	10, 10, 10	20
Resting pools (length x width x depth)				
Upper (m)	1.45 x 1.18 x 2.00	2.35 x 1.45 x 2.50	1.5 x 1.6 x 2.2	no resting pools
Lower (m)	1.39 x 1.13 x 1.61	3.50 x 1.45 x 2.50	1.5 x 1.6 x 2.2	no resting pools

Fishway depths, discharges, velocities and water surface profiles are interdependent and relationships between them for Denil fishways are provided in section 5.2. Water surface profiles within each fishway were derived from the measurements obtained during the assessment. Water depths in the fishway were calculated as the distance from the baffle crest ("V") to the water surface. Water depths near the fishway exit were free of backwater effects and were selected to estimate fishway discharge and velocity.

The Fairford, Cowan and Freeport fishways correspond to the standard or Denil 2 design. The dimensionless discharge relationship from Table 5.2 reduces to the following discharge rating curves which were used to estimate the discharge through each fishway from the measured water depths (Figs. 7.3 and 7.4):

$$\text{Fairford fishway:} \quad Q = 0.58y_o^{2.0} \quad (7.1)$$

$$\text{Cowan fishway:} \quad Q = 0.66y_o^{2.0} \quad (7.2)$$

$$\text{Freeport, west bank (10%):} \quad Q = 0.56y_o^{2.0} \quad (7.3)$$

$$\text{Freeport, east bank (20%):} \quad Q = 0.79y_o^{2.0} \quad (7.4)$$

where y_o is in m and Q in m^3/s .

Results from hydraulic model studies were used to estimate water velocities along the center line of each fishway at a location near the fish exit, where no backwater effect was detected. Water velocities in plain Denil fishways are low at the bottom of the flume, and increase upwards to the water surface. A layer of fast water exists near the water surface. This implies that fish ascending the fishway face varying water velocities dependent on their swimming depth. A representative range of velocities that fish may have had to negotiate at Cowan, Fairford and Freeport were estimated by calculating velocities corresponding to $0.2y_o$, $0.4y_o$ and $0.6y_o$, where y_o is the water depth in the fishway (Figs. 7.3 and 7.4).

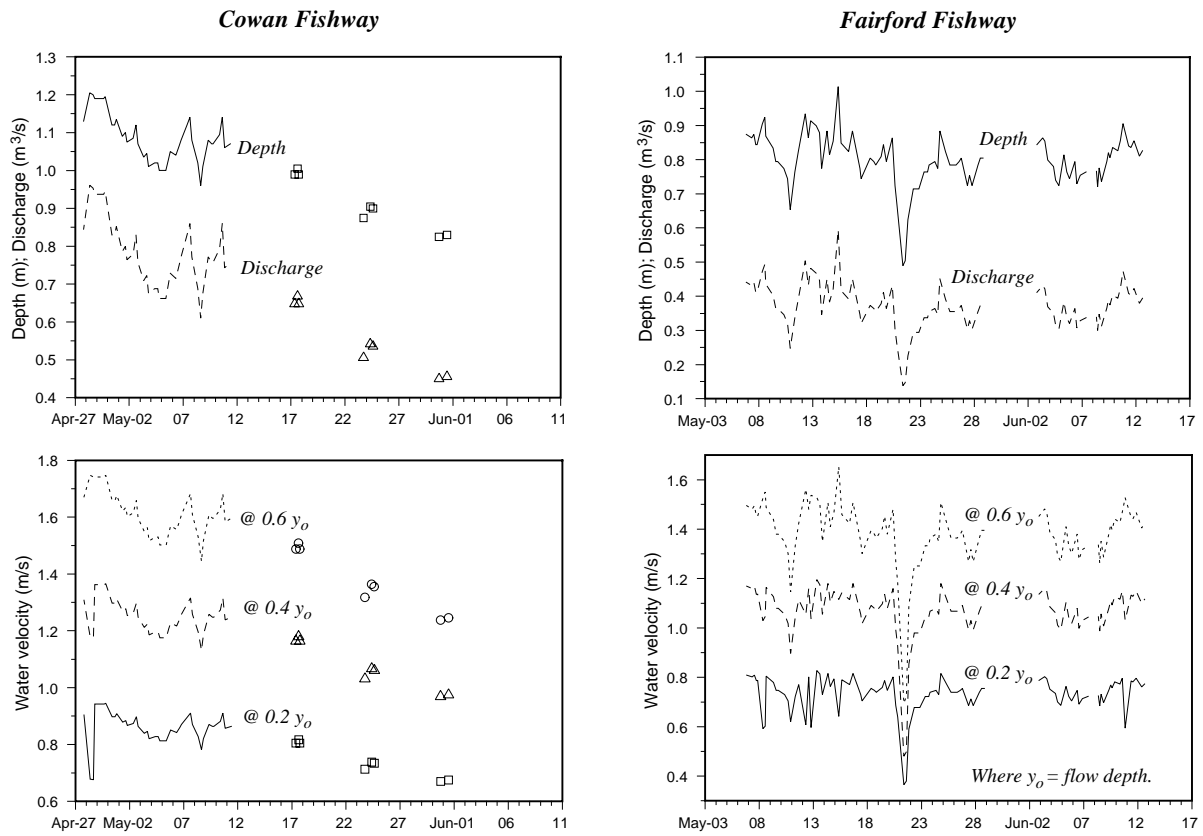

Figure 7.3 Depth, discharge and velocity profiles for Cowan (1985) and Fairford (1987) fishways.

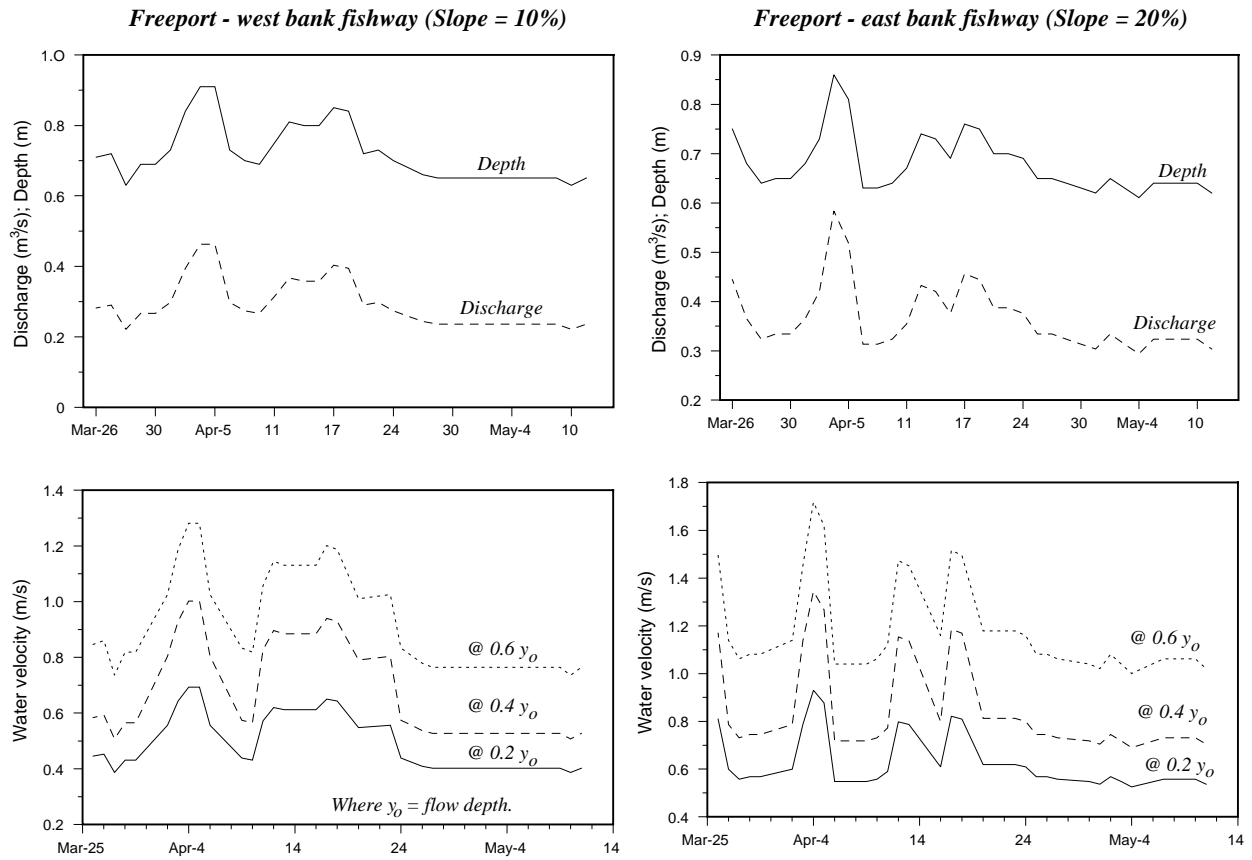

Figure 7.4 Depth, discharge and velocity profiles for the fishways in the Grand River Weir at Freeport (1990).

At Fairford, 8,871 fish representing 13 species were caught in the trap (Table 7.2). White sucker *Catostomus commersoni*, walleye *Stizostedion vitreum* and sauger *Stizostedion canadense* made up 93.0% of the run and over half of all fish caught were white suckers. At Cowan, 11,294 fish consisting of four species were trapped (Table 7.3), although it was estimated that over 23,000 fish passed through the fishway. These consisted of white suckers, longnose suckers *Catostomus catostomus*, northern pike *Esox lucius* and walleyes. At Fairford, 85.8% of the walleyes caught ranged in size from 300 mm to 400 mm fork length (FL); 92.3% of the sauger were between 250 mm and 350 mm.

Table 7.2 Fish passage summary for the Fairford Denil fishway from the 1987 field evaluation.

Species	Counted at exit		Measured at exit		Fork lengths (mm)		
	Number	% ^a	Number	% ^b	Range	Interval	% ^c
White sucker	5,032	56.7	496	9.9	214-524	350 - 500	94.4
Walleye	2,313	26.1	2,193	94.8	236-682	300 - 400	85.8
Sauger	907	10.2	854	94.2	212-398	250 - 350	92.3
Cisco	352	4.0	47	13.4	220-296	225 - 275	83.0
Other ^d	267	3.0					
Total	8,871						

a) Percentage is based on total number of fish counted for all species.

b) Percentage is based on number of fish counted for each species.

c) Percentage is based on number of fish measured for length.

d) 175 (2.0%) shorthead redhorse; 79 (0.9%) carp; 4 burbot; 3 lake whitefish; 2 freshwater drum; 1 longnose sucker; 1 silver redhorse; 1 quillback; 1 channel catfish.

Table 7.3 Fish passage summary for the Cowan Denil fishway from the 1985 field evaluation.

Species	Counted at exit		Measured at exit		Fork lengths (mm)		
	Number	% ^a	Number	% ^b	Range	Interval	% ^c
White sucker	5,054	44.8	1,229	24.3	250-498	350-500	96.6
Longnose sucker	4,803	42.5	746	15.5	347-532	350-500	93.7
Northern pike	1,095	9.7	853	77.9	324-800	350-500	96.8
Walleye	342	3.0	341	99.7	265-480	350-450	90.0
Total	11,294						

Note: a, b, c same as in Table 7.2.

At Cowan, 96.8% of the northern pike ranged from 350 mm to 500 mm, and 90.0% of the walleyes from 350 mm to 450 mm. Headwater levels at Fairford were fairly constant, but decreased at Cowan over the study period. This was reflected in the water depths measured in each fishway, and in the estimated fishway discharges and velocities. At the upstream end of the fishway at Fairford, water depths remained fairly constant at approximately 0.8 m, although they ranged from 0.5 m to 1.0 m. At Cowan, depths at the fishway decreased over time from about 1.2 m to 0.8 m. Estimated discharges through each fishway ranged from 0.14 to 0.59 m³/s at Fairford and from 0.45 to 0.96 m³/s at Cowan. Estimated water velocities were low near the bottom of each fishway (0.7 - 0.9 m/s) and high near the water surface (≥ 1.5 m/s). At specific water depths, velocities fluctuated around average or trend lines. Over the respective evaluation periods, these trend lines remained fairly constant at Fairford, while continuously decreased at Cowan. Although all species caught were able to ascend both fishways, northern pike waited 2 to 3 weeks before using the fishway at Cowan. Long residence time by northern pike below this and other dams may be a reflection of behaviour in relation to foraging, spawning, or passing through Denil fishways. More comprehensive studies with northern pike are under way.

At Freeport, 1,590 fish representing 8 species were trapped at the west bank fishway while only 314 fish representing 7 species were caught at the east bank fishway (Table 7.4 and 7.5). Fish strongly preferred the west bank fishway (10% slope) as 82.5% of the total number of fish used this fishway compared to only 17.5% which used the east bank fishway (20% slope; Fig. 7.5)

Table 7.4 Fish passage summary for the Freeport Denil fishway on the west bank (10% slope) from the 1990 field evaluation.

Species	Counted @ exit		Measured @ exit		Fork lengths (mm)		
	Number	% ^a	Number	% ^b	Range	Interval	% ^c
Carp	12	0.8	12	100	400 - 645	500 - 600	83.3
Chub	4	0.3	4	100	175 - 196	150 - 200	100
Common shiner	1100	69.2	9	0.8	95 - 165	150 - 190	55.5
Hognose sucker	149	9.4	149	100	152 - 337	250 - 300	43
Moxostoma species	110	6.9	110	100	162 - 523	250 - 300	30
Rock species	118	7.4	29	24.6	120 - 214	150 - 200	72.5
Smallmouth bass	19	1.2	19	100	232 - 377	250 - 300	53
White sucker	78	4.9	78	100	186 - 366	200 - 250	41
Total	1590						

Note: a, b, c same as in Table 7.2.

Table 7.5 Fish passage summary for the Freeport Denil fishway on the east bank (20% slope) from the 1990 field evaluation.

Species	Counted @ exit		Measured @ exit		Fork lengths (mm)		
	Number	% ^a	Number	% ^b	Range	Interval	% ^c
Carp	1	0.3	1	100	551		
Chub	4	1.3	4	100	115 - 142	100 - 150	100
Common shiner	123	39.2	6	4.9	86 - 170	150 - 200	67
Hognose sucker	98	31.2	98	100	164 - 329	300 - 350	55
Moxostoma species	34	10.8	34	100	229 - 492	300 - 350	56
Smallmouth bass	18	5.7	18	100	258 - 413	250 - 300	56
White sucker	36	11.5	36	100	115 - 349	200 - 350	88
Total	314						

Note: a, b, c same as in Table 7.2.

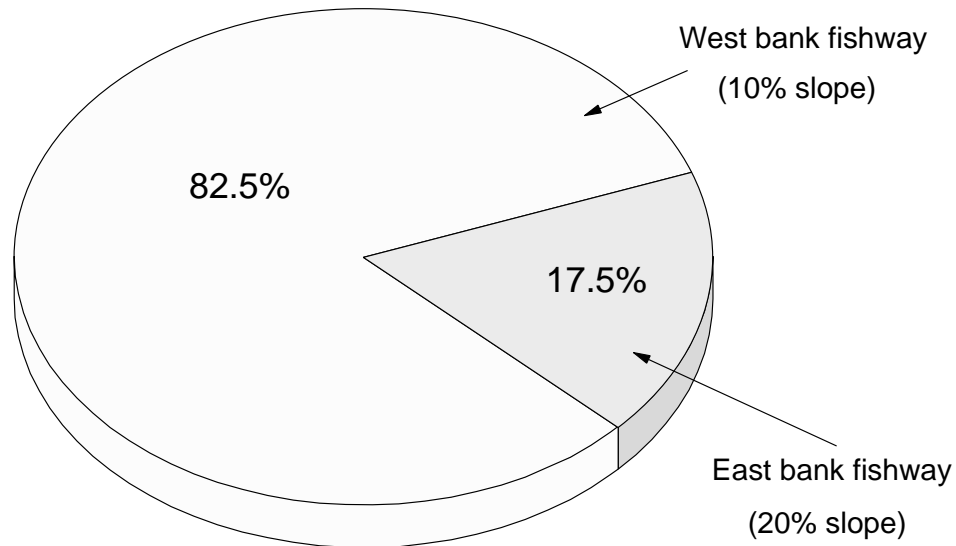
**Figure 7.5** Percentages of the total number of fish using the two fishways in the Grand River Weir at Freeport (1990).

8 DESIGN EXAMPLES

8.1 Altrude Creek Culvert

Public Works Canada (PWC) used three culverts at the Trans-Canada Highway (TCH) crossing of Altrude Creek in Banff National Park (Table 7.1, Fig. 8.1). While all three culverts would assist with flood flows, the culvert arrangement is intended to allow fish passage through the first culvert and ice passage through the third culvert. Altrude Creek flows north to the Bow River and has been identified as the best fish-producing stream that will be intersected by the TCH.

Table 8.1 Altrude Creek culvert dimensions.

Culvert	Size & Type	Length (m)	Slope (%)	Inlet Elev.(m)	Outlet Elev. (m)
1-F Fish	3100 mm x 1980 mm S.P.C.S.P.A.	73	0.5	1430.0	1429.64
2-N Normal	3100 mm x 1980 mm S.P.C.S.P.A.	71	1.0	1430.3	1429.79
3-I Ice	1600 mm diameter C.S.P	69	1.0	1431.2	1430.51

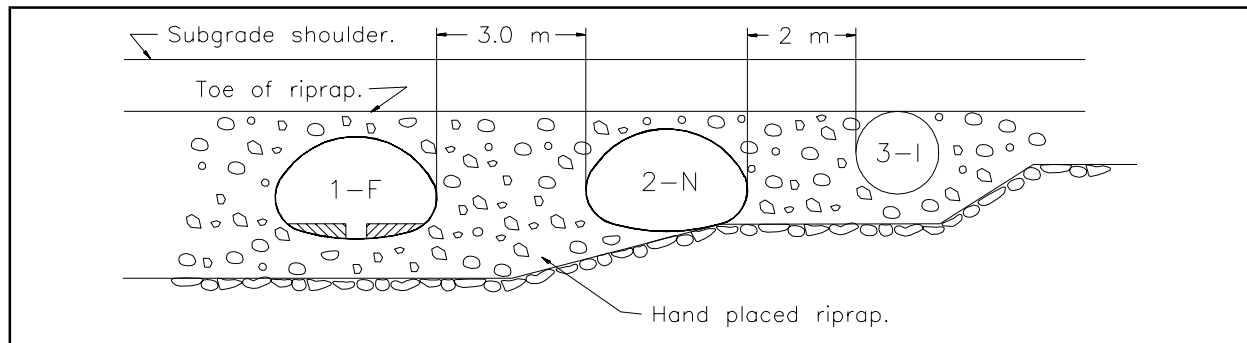

Figure 8.1 Altrude Creek culverts - end view.

8.1.1 Fish migration discharge

Field studies determined that late summer or fall spawning migrations of mountain whitefish, brook and bull trout occurred in Altrude Creek. A fall fish migration period of September 15 to October 31 was assumed and Redearth Creek records were used to estimate Altrude Creek flows (Table 8.2). From frequency analysis (Table 4.1; Fig. 4.1) a value of $5.3 \text{ m}^3/\text{s}$ was found for the fall fish migration discharge of Redearth Creek. This corresponds to a value of $2.9 \text{ m}^3/\text{s}$ for Altrude Creek.

Table 8.2 Altrude Creek discharges (Q_A) estimated from recorded flows of Redearth Creek (Q_R) obtained from Water Survey of Canada, Historical Streamflow Summary for Alberta to 1986.

Discharge description	Q_R (m ³ /s)	Q_A (m ³ /s)
October mean monthly flow	1.77	0.96
September mean monthly flow	3.16	1.72
average of Sept. and Oct. means	2.47	1.34
fall fish migration discharge (Sept.15-Oct.31)	5.3	2.9

Note: Drainage areas of Altrude and Redearth creeks were estimated as 80 km² and 147 km², respectively; $Q_A = (80/147) Q_R = 0.54 Q_R$

8.1.2 Fish passage design

PWC estimated water velocities in the culvert for several discharges and these are summarized in Table 8.3. Figure 8.2 presents graphically the PWC estimates from Table 8.3. Two points are highlighted because they appear inconsistent. Uncertainties existed as to the discharge estimates and the extent of the fish migration period. According to PWC calculations even the lowest fishway design flow estimate would result in excessive culvert velocities. Assuming a fish length of 200 mm, which is larger than the migrating fish found in Altrude Creek, Fig. 6.5 provides a fish passage velocity of approximately 0.5 m/s for a maximum swimming distance equal to the culvert length. Furthermore, flow acceleration is expected to produce higher velocities at the culvert inlet. It was therefore recommended that additional provisions be made to ensure fish passage for the fall spawners through the proposed culvert at Altrude Creek.

Table 8.3 Discharges (Q_F), velocities (V_F) and depths (d_F) for the fish passage culvert and corresponding headwater elevations (HW) and stream discharges (Q) at Altrude Creek crossing (PWC estimates).

	HW (m)	Q (m ³ /s)	Q_F (m ³ /s)	V_F (m/s)	d_F (m)
	1432.14	19.55	9.80	2.02	1.98
	1431.45	9.18	5.20	1.30	1.45
Projected from Fig.8.2			2.9	0.8	1.1
	1431.17	2.93	1.60	0.48	1.17
	1430.97	2.57	1.84	0.58	0.97
	1430.91	1.38	0.84	0.33	0.91

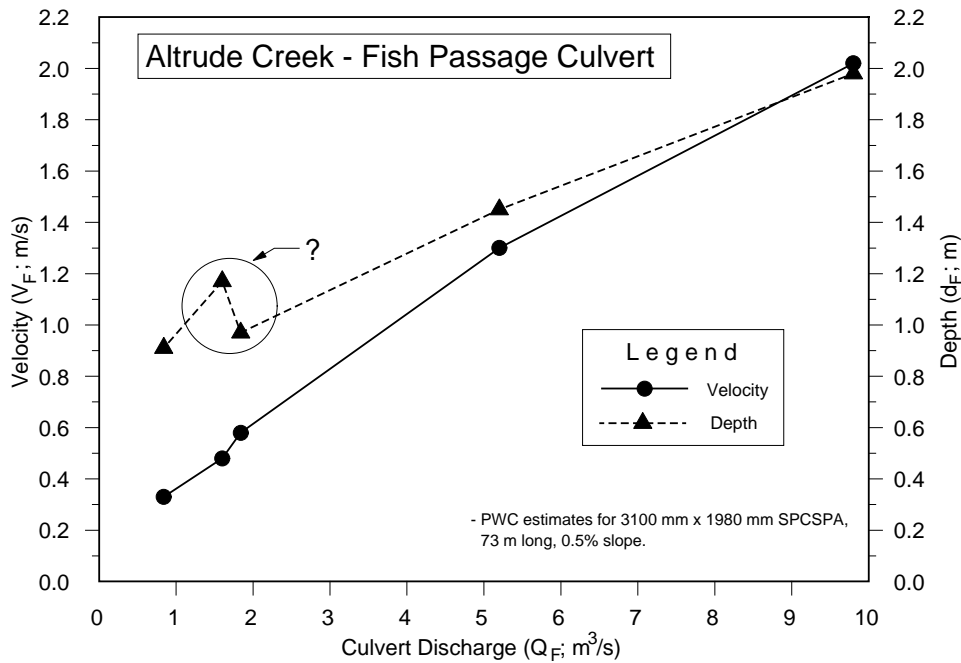

Figure 8.2 Depth and velocity vs discharge for fish passage culvert at Altrude Creek.

The proposed arrangement of the three culverts at the Altrude crossing did not allow for stream width and slope to be maintained so the stream simulation technique was unsuitable. Various fish passage devices were considered and the slotted-weir was selected for detailed design (Fig. 5.6).

Highest water velocity in the slotted weir baffle culvert fishway occurs through the slots in the weirs. The six slotted weir baffle fishway designs presented in Table 5.6 were evaluated using the dimensionless discharge equations and velocity scales to determine maximum water velocities at the slots, based on the fish passage flow. The slotted weir baffled culvert design is acceptable when the water velocity through the slots is within the burst swimming ability of the design fish species. Although the equations in Table 5.6 were developed for circular culverts, they were used to approximate discharge and velocity in the Altrude Creek pipe arch culvert. For the Altrude Creek pipe arch culvert the vertical height of the culvert (1980 mm) was selected in place of the diameter (D). The steps used to calculate velocity for design D-1 are presented below.

The dimensionless discharge equation for design D-1 was selected from Table 5.6 and used to determine the y/D value which produced a discharge which was equal to the fish passage flow of 2.9 m³/s (Table 8.2) at Altrude Creek. The Altrude Creek fish passage culvert had dimensions $D=1.98$ m and $S=0.5\%$.

$$\text{For design D-1 (Table 5.6): } Q_* = 9.2 \left(\frac{y_o}{D} \right)^{3.0} \quad (8.1)$$

$$\text{from (5.1) \& (8.1): } Q = 9.2 \left(\frac{y_o}{D} \right)^{3.0} \sqrt{g S_o D^5} \quad (8.2)$$

$$Q = 9.2 \left(\frac{y_o}{D} \right)^3 \sqrt{9.81 \cdot (0.5/100) \cdot 1.98^5} \quad (8.3)$$

$$\text{try: } y_o/D = 0.70 \quad Q = 3.8 \text{ m}^3/\text{s} > Q_{3d} = 2.9 \text{ m}^3/\text{s}$$

$$\text{try: } y_o/D = 0.60 \quad Q = 2.4 \text{ m}^3/\text{s} < Q_{3d} = 2.9 \text{ m}^3/\text{s}$$

$$\text{try: } y_o/D = 0.64 \quad Q = 2.9 \text{ m}^3/\text{s} = Q_{3d} = 2.9 \text{ m}^3/\text{s}$$

This and similar calculations for several other weir baffle designs are summarized in Table 8.4. Once the correct y_o/D value has been determined from the discharge equation, the maximum water velocity can be calculated:

$$\text{For design D-1 (Table 5.6): } U_* = 9.2 \left(\frac{y_o}{D} \right) \quad (8.4)$$

$$\text{from (5.2) \& (8.4): } U = 9.2 \left(\frac{y_o}{D} \right) \sqrt{g S_o D} \quad (8.5)$$

$$\text{when } \frac{y_o}{D} = 0.64 \quad U = 1.8 \text{ m/s}$$

Table 8.4 Summary of discharge and water velocity calculations based on the slotted weir baffle designs in Table 5.7 for the fish passage culvert at Altrude Creek.

Design	L (m)	z _o (m)	y _o /D	Q _*	Q (m ³ /s)	U _*	U (m/s)
D-1	1.2	0.3	0.70	3.2	3.8	6.4	2.0
			0.60	2.0	2.4	5.5	1.7
			0.64	2.4	2.9	5.9	1.8
D-2	0.6	0.3	0.64	2.4	2.9	5.9	1.8
D-3	2.4	0.3	0.59	2.4	2.9	6.4	2.0
D-4	4.8	0.3	0.57	2.4	2.9	7.2	2.2
D-5	1.2	0.2	0.55	2.4	2.9	6.2	1.9
D-6	2.4	0.2	0.54	2.4	2.9	6.7	2.1

Based on the velocity of 1.8 m/s calculated above a 200 mm trout would be able to travel approximately 0.5 m before fatiguing (Fig. 6.5) which is acceptable in allowing the fish to pass through the high velocity areas at the slot. Given the uncertainties on Altrude Creek flow estimates and the approximation of the arch culvert hydraulics, D-1 was selected as a conservative design. Slotted-weirs, 0.3 m in height, adapted to the pipe arch cross-section and spaced at 1.2 m intervals at the bottom of the proposed culvert (Fig. 8.3), would provide fish with the opportunity to pass through the culvert using a burst and rest swimming pattern.

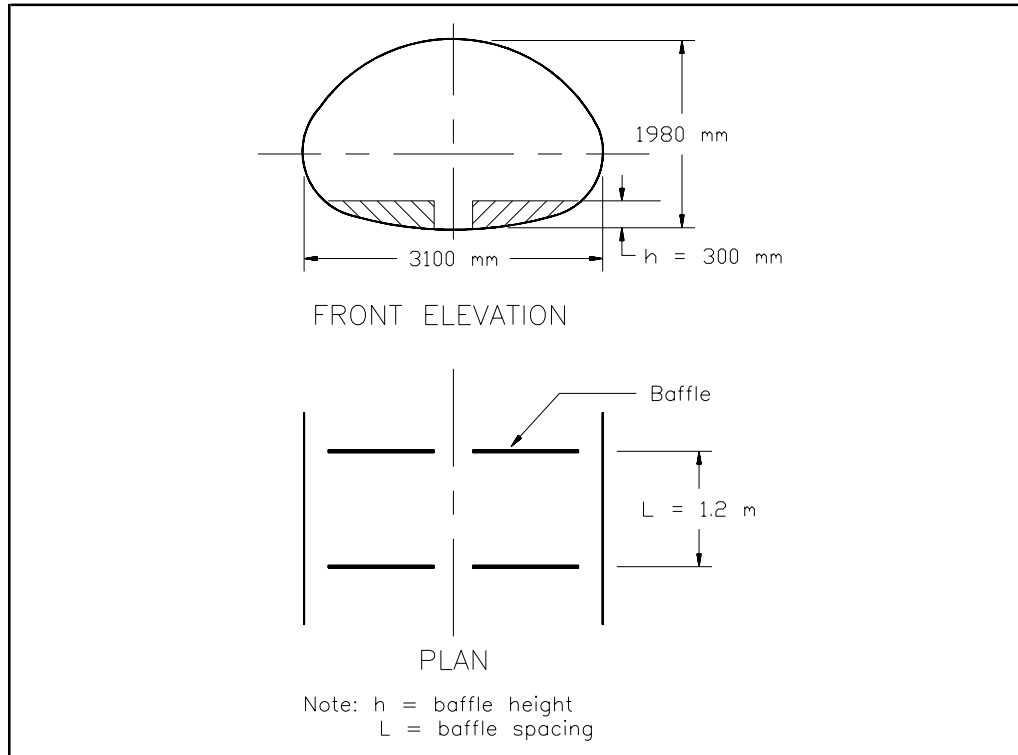

Figure 8.3 Slotted weir culvert fishway for Altrude Creek.

8.2 Hunt Dam Vertical Slot Fishway

The Hunt Dam (Fig 8.4), located on the Thames River in London, Ontario was identified as an obstacle which prevented fish from gaining access to approximately 100 km of upstream habitat. Observations of fish runs at the base of the dam noted the following species: walleye, rainbow trout, chinook salmon, northern pike, yellow perch, mooneye, sucker and carp. The purpose of the Hunt Dam fishway was to expand seasonal spawning migrations of walleye, rainbow trout and Chinook salmon in order to increase angling opportunities upstream of the dam.

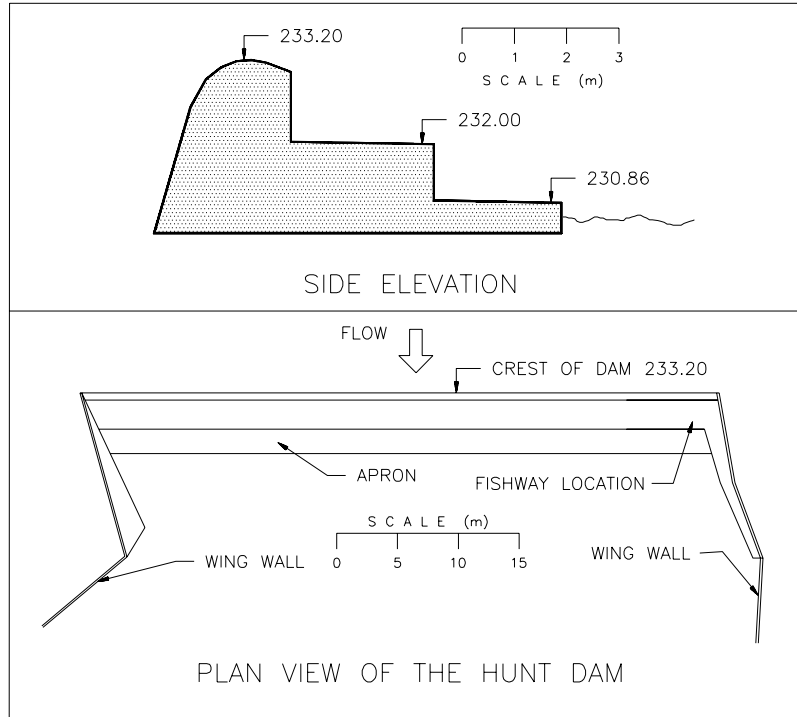

Figure 8.4 Side elevation and plan view of the Hunt Dam.

Table 8.5 Biological data for the Hunt Dam fishway.

Design species:	walleye
Mean length (mm):	350
Upper length (mm):	660 - 700
Spring migration:	March 15 - April 15
Water temperature (°C):	5 to 10

Using the method shown in Section 4 the fishway design flow during the migration period at Hunt Dam, based on the 1:10 year, 3 day delay discharge (Q_{3d}) was calculated to be:

$$\begin{aligned} \text{max flow:} & \quad Q_{3d} = 155 \text{ m}^3/\text{s} \text{ (1:10 year, 3 day delay)} \\ \text{min flow:} & \quad Q_{\min} = 5 \text{ m}^3/\text{s} \end{aligned}$$

The discharge rating curves for the headwater and tailwater of the Hunt Dam are shown in Figure 8.5. Water levels at the dam during migration were determined from the discharge rating curves based on the maximum and minimum fishway design flows.

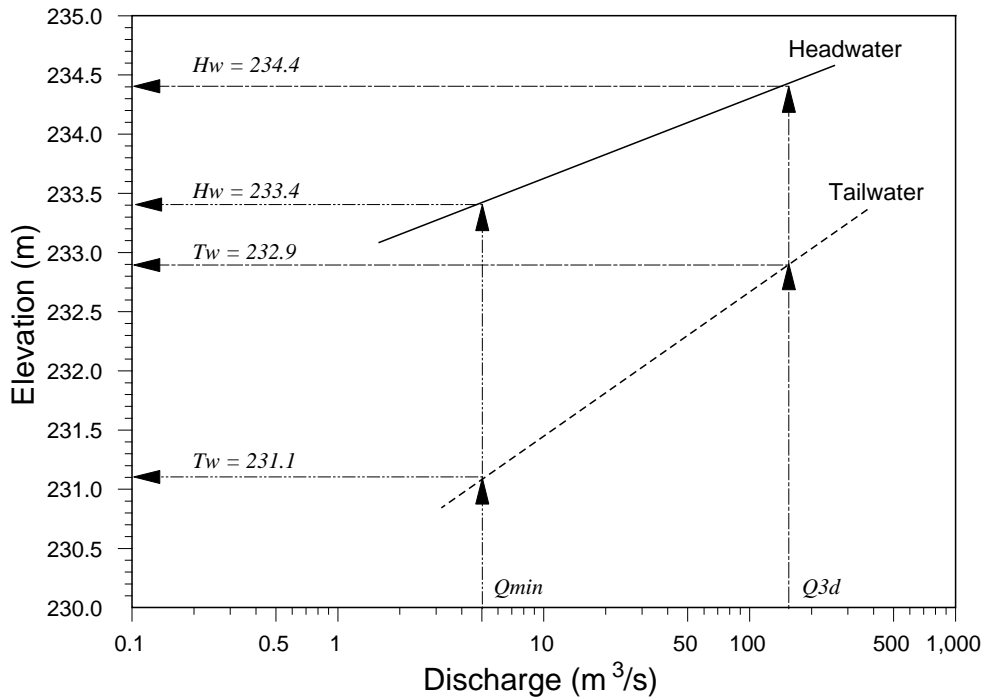

Figure 8.5 Hunt Dam discharge rating curves.

From Figure 8.5 the maximum and minimum upstream (headwater, H_w) and downstream (tailwater, T_w) water elevations were estimated as:

	H_w (m)	T_w (m)
maximum	234.4	232.9
minimum	233.4	231.1

Dam configuration from Fig. 8.4: crest of weir = 233.2 m
d/s concrete floor = 230.86 m

8.2.1 Design Calculations

Due to the range of tailwater levels expected at the Hunt Dam during the fish migration period, experience indicated that the vertical slot fishway would probably be the most effective for this location. The vertical slot fishway design #18 (Fig. 5.1) was selected for the Hunt Dam fishway, based on its good hydraulic characteristics and ease of construction.

Invert elevations for the upstream and downstream ends of the fishway were established from the minimum headwater and tailwater elevations calculated previously. Fishway inverts were set slightly lower than the minimum water level elevations in order to ensure adequate flow depth in the fishway during low flow periods. For vertical slot fishways 0.6 m is a common minimum depth

for proper operation. At the Hunt Dam, the upstream invert elevation was set at 232.8 m, i.e. 0.6 m below the minimum water elevation or 0.4 m below the weir crest. The downstream invert elevation was set at 230.3 m, i.e. 0.56 m below the concrete apron. The difference between the upstream and downstream invert elevations is the total head drop for which a fishway must be designed. For the Hunt Dam the head drop was:

$$H = 232.8 - 230.3 = 2.5 \text{ m} \quad (\text{total change in head})$$

In the design of vertical slot fishways, the recommended drop per pool (h) for freshwater fish is 200 mm, and 300 mm for salmon. Therefore, for walleye $h = 200$ mm. The number of pools required is based on the number of drops needed to equal the total head drop between the upstream and downstream invert elevations.

$$\text{number of drops} = H/h = 2.5/0.2 = 12.5 \text{ drops}$$

Thirteen pools are required to provide a 2.5 m head drop. With 13 pools the head drop per pool is:

$$h = 2.5/13 = 0.19 \text{ m} = 190 \text{ mm}$$

For vertical slot fishways the pool and baffle dimensions are a function of the slot width (b_o), see Figure 5.1. The size of the slot width is usually based on the maximum size of fish which will be using the fishway. Chinook salmon with an upper length range of 750 to 900 mm had been identified as one species which would use the fishway. In order to provide these large fish with adequate room to maneuver through the slots a slot width of 300 mm was selected. Pool and baffle dimensions are shown in Figure 8.6, note the pool width was rounded up to 2.5 m. The height of the pool walls in vertical slot fishways is based the maximum water elevations at the upstream and downstream ends of the fishway expected during the migration period.

The critical zone in terms of fish passage through vertical slot fishways is at the slot. It is in this area that fish are confronted with the highest water velocities. Fish usually use burst swimming to pass the high velocity zone at the slot. The water velocity in the slot is relatively constant from top to bottom and can be calculated using equation 5.4. Slot velocity for the Hunt Dam vertical slot fishway:

$$u_m = \sqrt{2 \cdot 9.81 \cdot 0.19} = 1.93 \text{ m/s}$$

For successful fish passage the fish swimming speed (V) must be greater than water velocity in slot (u_m). The swimming distance vs water velocity plot (Figs. 6.4 and 6.5) can be used to determine if the slot velocity exceeds the swimming ability of the design fish species. With vertical slot fishways the swimming distance (X_{max}) is based on length of the water jet at the slot. For the Hunt Dam fishway this distance was estimated to be 0.5 m. From Figure 6.5 a 350 mm walleye can swim 0.5 m against a water velocity of 3.0 m/s. Since this velocity is greater than the slot velocity, a 350 mm walleye will be able to move through the slot and therefore this design is acceptable.

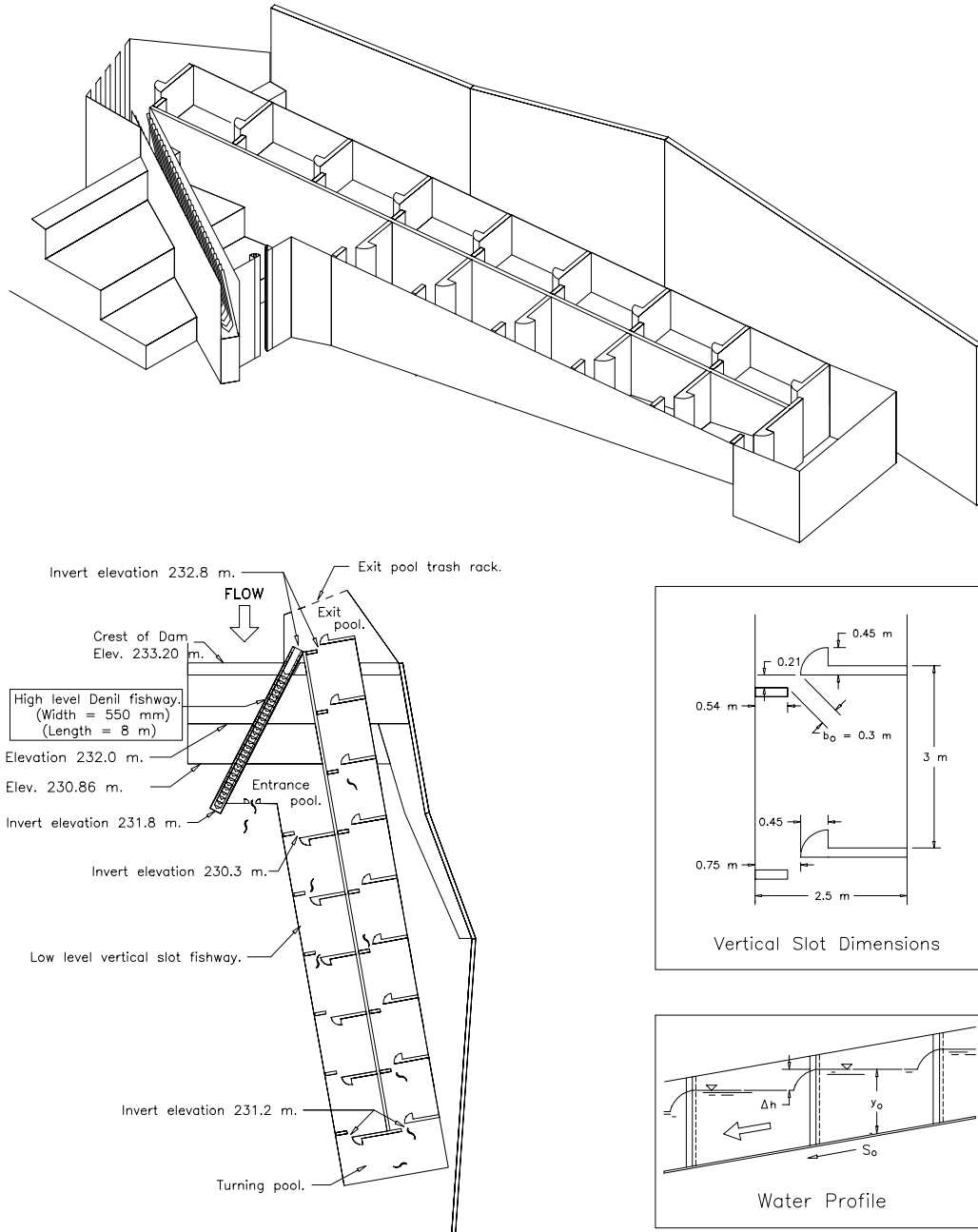

Figure 8.6. Isometric and plan view of the Hunt Dam fishways.

The recommended layout for the Hunt Dam fishway is shown in Figure 8.6. The use of two fishways was recommended in order to provide more effective fish passage. A turning pool was incorporated into the vertical slot fishway in order to locate the fishway entrance near the base of the dam where fish are known to congregate. A plain Denil fishway located adjacent to the vertical slot fishway was designed to provide attraction water near the entrance of the vertical slot fishway, as well as providing an alternate, more direct route upstream during high tailwater levels.

9 FISHWAY COSTS

Fishway costs vary substantially from site to site and for new or retrofit structures. Costs can be reduced by taking full advantage of site conditions and incorporating fishways when dams are first constructed or replaced. Tables 9.1 and 9.2 provide available data on costs (in Canadian dollars) of several fishways built since 1980 in the provinces of Alberta, Saskatchewan, Manitoba and Ontario. Denil fishways in Alberta, overcoming a vertical rise of 0.5 to 2 m have ranged in cost from \$15,000 to \$30,000 each or a unit cost of \$10,000 to \$20,000 per m rise (for a rise of 1 m or more). Two Denil fishways at the same dam have ranged in cost from \$38,000 (or \$15,500 per m rise; Alberta) to \$75,000 (or \$26,800 per m rise; Saskatchewan). The cost of two Denils on the Grand River near Freeport, Ontario, was estimated at \$50,000 (or \$15,000 per m rise). Unit costs in Washington and Oregon ranged from \$10,000 per m rise for small weir fishways to \$200,000 per m rise for a vertical slot fishway with flow control, multiple entrances, auxiliary water supply and flood and debris protection. In addition to site conditions, costs may vary with project scope, fishway type, contracting considerations, design and specification details, fabrication methods and construction techniques.

Table 9.1 Unit costs (\$ per m of vertical rise) for several fish passage facilities built between 1980 and 1989 in Ontario, Manitoba, and Saskatchewan.

FACILITY	SOURCE	CONSTRUCTION INFORMATION	DESIGN SPECIES	TOTAL RISE(m)	TOTAL COST(\$)	UNIT COST(\$/m)
<u>ONTARIO</u>						
Thornbury Fishlock	MNR	1980-Retrofit	Chinook salmon	7.02	272 000	37 700
Walkerton fish bypass channel	MNR	1980-Retrofit	Rainbow trout	2.18	74 000	33 900
Haines fish bypass channel	MNR	1987-Retrofit	Rainbow trout	1.67	55 000	32 900
Grand River at Freeport ¹	AE	1989-New Concrete; metal baffles	Walleye	3.34	50 000	15 000
<u>MANITOBA</u>						
Fairford Denil fishway	DNR	1984-Retrofit; Timber Attraction water flume	Walleye	2.49	113 734	45 676
<u>SASKATCHEWAN</u>						
Cowan Denil fishway	PRW	1985-Retrofit Concrete; metal baffles	Northern pike	3.20	124 686	38 964
Kampsack (2 Denil fishways with a vertical rise of 1.40m each)	PFRA	1988-New Concrete; metal baffles	Walleye	2.80	75 000	26 786

1. Two fishways rising 1.67 m each.

Table 9.2 Unit costs (\$ per m of vertical rise) for fabrication and installation of standard Denil fishways built between 1983 and 1988 in Alberta (Source Alberta Environment).

FACILITY	CONSTRUCTION INFORMATION	DESIGN SPECIES	TOTAL RISE (m)	COST(\$)			UNIT COST(\$)		
				FABRI-CATE	INSTALL	TOTAL	FABRI-CATE	INSTALL	TOTAL
Lesser Slave Lake ¹	1983-Retrofit; Timber	N. Pike Goldeye	1.84	10 000	13 000	23 000	5 435	7 065	12 500
Beaverlodge ²	1984-Retrofit; Steel	Arctic grayling N. Pike	1.63	12 500	2 600	15 100	7 669	1 595	9 264
Ethel Lake	1986-New; Steel	N. Pike Walleye	0.50	15 000	5 000	20 000			
Cadotte Lake	1988-Retrofit; Steel	N. Pike Walleye	1.29	23 000	3 600	26 600	17 829	2 791	20 620
Parlby Creek:									
Spotted Lake	1988-Retrofit; Steel	N. Pike	1.20	12 500	7 500	20 000	10 417	6 250	16 667
Carlyle	1988-Retrofit; Steel	N. Pike	1.25	10 500	7 500	18 000	8 400	6 000	14 400
		TOTAL	2.45	23 000	15 000	38 000	9 388	6 122	15 510

1. Two fishways rising 0.94m and 0.90m respectively.

2. Two fishways rising 0.74m and 0.89m respectively.

10 NOTATION

B	width of fishway
b_o	width of fish passage opening
D	diameter of culvert
d	depth of surface jet for streaming weir flow
F_f	dimensionless fish speed
F	dimensionless water velocity
g	gravitational acceleration
h	hydraulic head
k	baffle notch height
l	fish length
L	pool length, baffle spacing
Q	discharge through fishway
Q_o	discharge through orifice
Q_w	discharge over weir
Q_*	dimensionless fishway discharge
Q_j	dimensionless discharge for submerged jet flow through the orifice
Q_p	dimensionless discharge for plunging weir flow
Q_s	dimensionless discharge for streaming weir flow
Q_t	dimensionless discharge for transitional weir flow
S_o	slope of fishway bed
t	fish endurance time
t_*	dimensionless fish endurance
u	time averaged water velocity
u_m	maximum value of u
u_m'	maximum value of u at 75% of depth
U	fish speed
U_*	dimensionless velocity scale
V	average water velocity
X	fish swimming distance
y_o	characteristic depth of flow
z_o	height of baffle, weir, sill
$\alpha, \beta, \eta, \lambda, C, K$	coefficients
ξ	relative maximum fish swimming distance
v	kinematic viscosity of water

11 SELECTED REFERENCES

11.1 Fishway Design

- Andrew, F.J. 1990. The use of vertical-slot fishways in British Columbia, Canada. Proc. International Symposium on Fishways '90, October 8-10, 1990, Gifu, Japan: p.267-274.
- Bates, K. 1991. Pool-and-chute fishways. American Fisheries Society Symposium 10:268-277.
- Behlke, C.E., D.L. Kane, R.F. McLean, and M.D. Travis. 1991. Fundamentals of culvert design for passage of weak-swimming fish. State of Alaska, Department of Transportation and Public Facilities, Fairbanks, Alaska. Report No. FHWA-AK-RD-90-10. xviii+159 p.
- Bell, M.C. 1973. Fisheries handbook of engineering requirements and biological criteria. Corps of Engineers, North Pacific Division, Portland, Oregon, U.S.A. 490p.
- Boiten, W. 1990. Hydraulic design of the pool-type fishway with V-shaped overfalls. Proc. International Symposium on Fishways '90, October 8-10, 1990, Gifu, Japan: p.483-490.
- Clay, C.H. 1961. Design of fishways and other fish facilities. Dept. of Fisheries of Canada, Ottawa, 301p.
- Collins, N.H. and G.F. Gillis. 1985. Upstream fish passage. Canadian Electrical Association, Montreal, Quebec.
- Dane, B.G. 1978. A review and resolution of fish passage problems at culvert sites in British Columbia. Can. Fish. Mar. Serv. Tech. Rep. 810:x+126p.
- Fleming, D.F. and J.B. Reynolds. 1991. Effects of spawning-run delay on spawning migration of Arctic Grayling. American Fisheries Society Symposium 10:299-305.
- Jordan, M.C., and R.F. Carlson. 1987. Design of depressed invert culverts. State of Alaska, Department of Transportation and Public Facilities, Fairbanks, Alaska. Report No. FHWA-AK-RD-87-23. 64p.
- Katopodis, C. 1990. Fishway References. Freshwater Institute, Dept. of Fisheries and Oceans, Winnipeg, Canada.
- Katopodis, C. 1990. Advancing the art of engineering fishways for upstream migrants. Proc. International Symposium on Fishways '90, October 8-10, 1990, Gifu, Japan: p.19-28.
- Katopodis, C. 1985. Drainage design considerations for fish passage. Proc. 3rd Western Provincial Conference, November 20-22, 1984, Manitoba Water Resources Branch, Winnipeg, Canada, p. 347-376.

- Katopodis, C. 1981a. Considerations in the design of fishways for freshwater species. Proc. 5th Can. Hydrotechnical Conference, Fredricton, N.B. p. 857-878.
- Katopodis, C. 1981b. Review of culvert fish passage methods for freshwater species. Proc. Resource Roads Workshop, Environmental Protection Service, Environment Canada, Ottawa. p. 202-220.
- Katopodis, C. 1977. Design of culverts for fish passage. Proc. 3rd National Hydrotechnical Conference, Quebec, Canada. p. 949-971.
- Larinier, M. 1990. Experience in fish passage in France: fish pass design criteria and downstream migration problems. Proc. International Symposium on Fishways '90, October 8-10, 1990, Gifu, Japan: p.65-74.
- Lonnebjerg, N. 1990. Fishways in Denmark. Proc. International Symposium on Fishways '90, October 8-10, 1990, Gifu, Japan: p.253-259.
- Mallen-Cooper, M and J. Harris. 1990. Fishways in mainland south-eastern Australia. Proc. International Symposium on Fishways '90, October 8-10, 1990, Gifu, Japan: p.221-229.
- Nakamura, S. and N. Yotsukura. 1987. On the design of fish ladder for juvenile fish in Japan. Proc. International Symposium on Design of Hydraulic Structures, Colorado State University, Fort Collins, Colorado. p. 499-508.
- Orsborn, J.F. 1987. Fishways - historical assessment of design practices, p. 122-130. In Dadswell, M.J. et al. (ed.) Proc. International Symposium, Common Strategies of Anadromous and Catadromous Fishes, American Fisheries Society, Bethesda, Maryland, U.S.A.
- Rainey, W.S. 1991. Recent adult fish passage projects on tributaries of the Columbia River. American Fisheries Society Symposium 10:278-288.
- Rytkonen, J. and A. Hepojoki. 1990. The design and construction of fishways in the north European conditions. Proc. International Symposium on Fishways '90, October 8-10, 1990, Gifu, Japan: p.245-251.
- Wang, Y. 1990. Design and application of fish passage and protection facilities in China. Proc. International Symposium on Fishways '90, October 8-10, 1990, Gifu, Japan: p.53-63.

11.2 Fishway Hydraulics

- Katopodis, C. and N. Rajaratnam. 1983. A review and laboratory study of the hydraulics of Denil fishways. Can. Tech. Rep. Fish. Aquat. Sci. 1145: viii + 181 p.
- Katopodis, C. and N. Rajaratnam. 1984. Similarity of scale models of Denil fishways. p. 2.8-1 to 2.8-6 In H. Kobus (Ed.) IAHR Symposium on Scale Effects in Modeling Hydraulic Structures, September 3-6, 1984. Technische Akademie Esslingen, W. Germany.

- Katopodis, C., P.R. Robinson, and B.G. Sutherland. 1978. A study of model and prototype culvert baffling for fish passage. *Can. Fish. Mar. Serv. Tech. Rep.* 828: v + 78 p.
- Larinier, M. 1978. Etude du fonctionnement d'une passe a poissons a ralentisseurs plans, *Bull. Fr. Piscic.* 51:40-54. Also "Operation of a fishway with flat baffles", *Can. Trans. Fish. Aquat. Sci.* 4789.
- Rajaratnam, N. and C. Katopodis. (in press). Fish protection. *In* M. Hino (ed.) *Water Quality*, #10, Chapter 5, *Hydraulic Structures Design Manual*. International Association for Hydraulic Research.
- Rajaratnam, N., C. Katopodis, and R. Paccagnan. (in press). Field studies of fishways in Alberta. *Can. J. Civil Engineering*. 19:June 1992
- Rajaratnam, N., C. Katopodis, and S. Solanki. (in press). New designs for vertical slot fishways. *Can. J. Civil Engineering*.
- Rajaratnam, N. and C. Katopodis. 1991. Hydraulics of steep pass fishways. *Can. J. Civil Engineering*. 18(6): 1024-1032.
- Rajaratnam, N., C. Katopodis and S. Lodewyk. 1991. Hydraulics of culvert fishways IV: Spoiler baffle culvert fishways. *Can. J. Civil Engineering* 18(1): 76-82.
- Rajaratnam, N., C. Katopodis and M.A. Sabur. 1991. Entrance region of circular pipes flowing partly full. *J. of Hydraulic Research, IAHR*, 29(5): 685-698.
- Rajaratnam, N., C. Katopodis and M.A. Fairbairn. 1990. Hydraulics of culvert fishways V: Alberta fish-weirs and baffles. *Can. J. Civil Engineering* 17(6): 1015-1021.
- Rajaratnam, N. and C. Katopodis. 1990. Hydraulics of culvert fishways III: Weir baffle culvert fishways. *Can. J. Civil Engineering* 17(4): 558-568.
- Rajaratnam, N., C. Katopodis and M. Mainali. 1989. Pool-orifice and pool-orifice-weir fishways. *Can. J. Civil Engineering* 16(5): 774-777.
- Rajaratnam, N., C. Katopodis and N. McQuitty. 1989. Hydraulics of culvert fishways II: Slotted-weir culvert fishways. *Can. J. Civil Engineering* 16(3): 375-383.
- Rajaratnam, N., C. Katopodis and S. Lodewyk. 1988. Hydraulics of offset baffle culvert fishways. *Can. J. Civil Engineering* 15(6): 1043-1051.
- Rajaratnam, N., C. Katopodis, and A. Mainali. 1988. Plunging and streaming flows in pool and weir fishways. *J. Hydraulic Engineering, ASCE* 114 (8): 939-944.
- Rajaratnam, N., C. Katopodis and L. Flint-Petersen. 1987. Hydraulics of two-level Denil fishways. *J. Hydraulic Engineering, ASCE* 113 (5):670-674.

- Rajaratnam, N., G. Van der Vinne and C. Katopodis. 1986. Hydraulics of vertical slot fishways. *J. Hydraulic Engineering*, ASCE 112 (10):909-927.
- Rajaratnam, N., C. Katopodis and G. Van der Vinne. 1985. M1-type backwater curves in Denil fishways. *Proc. 7th Can. Hydrotechnical Conference, Saskatoon, SK. Vol. IB. p. 141-156.*
- Rajaratnam, N. and C. Katopodis. 1984. Hydraulics of Denil Fishways. *J. Hydraulic Engineering*, ASCE 110 (9): 1219-1233.

11.3 Ichthyomechanics

- Beamish, F.W.H. 1978. Swimming capacity, 101-187. *In: W.S. Hoar and D.J. Randall (ed.) Fish Physiology, Vol. 7. Academic Press, New York.*
- Katopodis, C. 1990. Biomechanics References. Freshwater Institute, Dept. of Fisheries and Oceans, Winnipeg, Canada.
- Katopodis, C. 1990. Ichthyomechanics. Freshwater Institute, Dept. of Fisheries and Oceans, Winnipeg, Canada.
- Lindsey, C.C. 1978. Form, function, and locomotory habits in fish. p. 1-100 *In W.S. Hoar and D.J. Randal (Ed.) Fish Physiology, Vol. VII, Locomotion. Academic Press, New York.*

11.4 Fishway Assessment

- Behlke, C.E., D.L. Kane, R.F. McLean, J.B. Reynolds, and M.D. Travis. 1988. Spawning migration of Arctic Grayling through Poplar Grove Creek culvert, Glennallen, Alaska, 1986. State of Alaska, Department of Transportation and Public Facilities, Fairbanks, Alaska. Report No. FHWA-AK-RD-88-09. xi+103 p.
- Blackett, R.F. 1987. Development and performance of an Alaska steep pass fishway for sockeye salmon (*Oncorhynchus nerka*). *Can. J. Fish. Aquat. Sci.* 44: 66-76.
- Definition et controle de l'efficacite des passes a poissons. *La Houille Blanche*, No. 1/2, 1987, 167p.
- Hooli, J. 1988. Studies in the fishway models. *Aqua Fennica* 18(2): 171-178.
- Kane, D.L., C.E. Behlke, D.L. Basketfield, R.E. Gieck, R.F. McLean and M.D. Travis. 1989. Hydrology, hydraulics and fish passage performance of Arctic Grayling (*Thymallus Arcticus*) at Fish Creek, Denali highway near Cantwell Alaska. State of Alaska, Department of Transportation and Public Facilities, Fairbanks, Alaska. Report No. FHWA-AK-RD-89-03. xiii+180p.

- Kane, D.L., and P.M. Wellen. 1985. A hydraulic evaluation of fish passage through roadway culverts in Alaska. State of Alaska, Department of Transportation and Public Facilities. Report No. FHWA-AK-RD-85-24. 54p.
- Katopodis, C., A.J. Derksen and B.L. Christensen. 1991. Assessment of two Denil fishways for passage of freshwater species. American Fisheries Society Symposium 10: 306-324.
- McKinnon, G.A. and F.N. Hnytka 1985. Fish passage assessment of culverts constructed to simulate stream conditions on Liard River tributaries. Can. Tech. Rep. Fish. Aquat. Sci. 1255:vi+121p.
- Pavlov, D.S. 1989. Structures assisting the migrations of non-salmonid fish: U.S.S.R. FAO Fisheries Technical Paper 308, Rome, Italy, 97p.
- Swalme, K., W.C. Mackay and D. Lindner. 1985. Suitability of vertical slot and Denil fishways for passing north-temperate, nonsalmonid fish. Can. J. Fish. Aquat. Sci. 42:1815-1822.
- Tilsworth, T., and M.D. Travis. 1987. Fish passage through Poplar Grove Creek. State of Alaska, Department of Transportation and Public Facilities, Fairbanks, Alaska. Report No. FHWA-AK-RD-87-15. 107p.