

A photograph of a rocky stream flowing through a dense forest. The water is turbulent, creating white rapids as it flows over moss-covered rocks. The surrounding trees are lush green, with some yellowing leaves visible, suggesting an autumn setting. The overall scene is a natural, serene landscape.

# **Erosion & Sediment Control Guideline for Urban Construction**

**December 2006**





# EROSION & SEDIMENT CONTROL GUIDELINES FOR URBAN CONSTRUCTION

DECEMBER, 2006

These erosion and sediment control guidelines have been prepared for common usage in an effort to coordinate the response of various municipalities and agencies involved in land development, construction and water management. While a wide variety of sediment control manuals exist in various North American jurisdictions, this document was created with regard for the principles and guidelines that best suit the Greater Golden Horseshoe Area Conservation Authorities (GGHA CAs), which are listed below.



The “Greater Golden Horseshoe Area Conservation Authorities’ Erosion and Sediment Control Guideline for Urban Construction” is intended to be applied within all member municipalities encompassed within the GGHA watersheds to protect and preserve the water quality, aquatic and terrestrial habitats, and form and function of their natural water resources. It was prepared to include best management practices from all of the various erosion and sediment control guidelines currently applied by municipal and provincial agencies within the Greater Golden Horseshoe Area (GGHA) with additional information from various sources. This guideline provides a consistent approach to erosion and sediment control (ESC) in the GGHA. It provides the practitioners with greater certainty in the application of ESC along with improved environmental protection.

The document has been reviewed by the GGHA Conservation Authorities, Fisheries and Oceans Canada, Environment Canada, and Ontario Ministry of Natural Resources and provides sediment control practices and mitigation measures, which if implemented appropriately, are meant to provide guidance to be used by the proponent and practitioners. It is the responsibility of the proponent and practitioners to stay up to date with current best management practices available. It is also the proponent’s and their representing agents’ responsibility to understand the sensitivity of the receiving ecosystem along with the level of protection provided by the different erosion and sediment control practices and to develop an erosion and sediment control plan that is appropriate for protecting the ecosystem. The advice in this document is related solely to erosion and sediment control at urban construction sites in the GGHA and it should be noted that this document does not release the proponent or practitioner from responsibility for obtaining any permits, approvals or authorizations required under federal, provincial or municipal legislation for any aspects of their plan, work, undertaking or activity.

## **ACKNOWLEDGEMENTS**

The following agencies provided funding for this project:

The Government of Canada's Great Lakes Sustainability Fund; and,  
Fisheries and Oceans Canada – Ontario – Great Lakes Area.

The Great Lakes Sustainability Fund is a component of the Federal Government's Great Lakes program. The Sustainability Fund provides resources for demonstrating and implementing technologies and techniques that help remediate Areas of Concern and other priority areas in the Great Lakes. The following report sponsored by the Great Lakes Sustainability Fund, addresses Erosion and Sediment Control issues within the Greater Golden Horseshoe Area Conservation Authorities. Although the report underwent technical review, it does not necessarily reflect the opinions or views of the Sustainability Fund or Environment Canada.

The Conservation Authorities also wish to thank Environment Canada and the Ministry of the Environment for their generous support for the Erosion and Sediment Control Guideline through the Toronto and Hamilton Remedial Action Plans (RAPs).

We would also like to acknowledge the valuable comments received from municipal staff, consultants and the development industry representatives.

## **DISCLAIMER**

The guidelines and procedures presented in this document are meant to serve as useful information that can be used to address erosion and sediment control (ESC) issues that result from urban construction activities. These guidelines and procedures should not be regarded as rigid, since those responsible for implementing them should employ innovative approaches that address site-specific conditions to protect the surrounding ecosystem. While the recommendations contained in this document have been researched and adopted from various ESC guidelines, no warranty, expressed or implied, is given on the accuracy of the document's contents or their extraction from reference publications. Nor shall the fact of distribution constitute any responsibility upon the GGHA Conservation Authorities, DFO, contributors, or others for any omissions, errors, or any possible misrepresentations that may result from the use or interpretation of the material contained herein. Mention of trade names or commercial products does not constitute endorsement or recommendation of those products. No financial support was received from developers, manufacturers or suppliers of technology used or evaluated in this document.

## TABLE OF CONTENTS

<b>1.0</b>	<b>Introduction .....</b>	<b>1</b>
1.1	Background .....	1
1.2	Guiding Principle .....	2
1.3	The Approach.....	2
1.4	The Focus .....	4
1.5	The Purpose .....	4
<b>2.0</b>	<b>Erosion and Sedimentation Processes .....</b>	<b>6</b>
<b>3.0</b>	<b>Regulations – Federal, Provincial, Municipal, and Conservation Authorities .....</b>	<b>9</b>
3.1	Federal.....	9
3.2	Provincial .....	12
3.3	Conservation Authority and Municipal.....	12
<b>4.0</b>	<b>Key Participants Roles and Responsibilities.....</b>	<b>14</b>
<b>5.0</b>	<b>Environmental Management.....</b>	<b>18</b>
5.1	Environmental Management Details for Erosion and Sediment Control Consideration . .....	18
<b>6.0</b>	<b>Developing an Effective Erosion and Sediment Control Plan.....</b>	<b>20</b>
6.1	Erosion and Sediment Control Plan Requirements .....	21
6.1.1	Erosion and Sediment Control Plan Requirements – Report.....	21
6.1.2	Erosion and Sediment Control Plan Requirements – Drawings. ....	23
6.2	Developing a Worksite Isolation Plan for In-stream Construction .....	25
6.3	Developing a Spill Control and Response Plan .....	27
<b>7.0</b>	<b>Inspections and Performance Monitoring.....</b>	<b>28</b>
<b>8.0</b>	<b>References .....</b>	<b>30</b>

## LIST OF TABLES

Table 1.	Roles and Responsibilities of Involved Parties.....	16
Table 2.	Erosion and Sediment Control Requirements – Report.....	22
Table 3.	Erosion and Sediment Control Plan Requirements - Drawing(s).....	24
Table 4.	MNR’s Fisheries Construction Timing Guideline (MNR, 1989).....	26

## LIST OF APPENDICES

<b>Appendix A</b>	Erosion Potential Reference Charts
<b>Appendix B</b>	References for Federal & Provincial Regulations, Municipal By-Laws and Conservation Authorities Act and References for Additional Information
<b>Appendix C</b>	Erosion Control Practices and Sediment Control Practices
<b>Appendix D</b>	Seed Mix Guidelines, April 2005
<b>Appendix E</b>	In-Stream Control Practices
<b>Appendix F</b>	Erosion and Sediment Control Inspection Report (Sample)



## **1.0 Introduction**

### **1.1 Background**

Soil erosion occurs naturally as a result of the dispersive action of rain and the power of water and wind to initiate soil detachment and transport soil particles across the surface. The extent of erosion losses will depend on climate, topography, and the ability of soils to resist detachment and infiltrate water, but a good vegetative cover can largely offset the effect of these factors. Plant cover and natural vegetative residue protect the soil from the impact of raindrops, slows runoff and enhances infiltration of water.

Unfortunately, the substantial benefits of vegetative cover are lost during the process of land development, because trees and plants are removed, natural drainage pathways are altered and stable topsoil aggregates are stripped away as part of the grading process. If left uncontrolled, erosion of exposed soils can cause local air quality problems, degradation of aquatic habitats, and damage to downstream recreational areas and infrastructure. Monitoring in the Greater Toronto Area shows that suspended solid concentrations in untreated runoff from construction sites can be up to 30 times greater than that of stabilized residential areas and roughly 90 to 100 times greater than stream concentrations downstream of agricultural areas (SWAMP, 2005; TRCA and U of G, 2006; TRCA 2006).

The deleterious effects of excess sediment discharges on aquatic life are well documented (e.g. Waters, 1995; Newcombe and MacDonald, 1991). Effects on fish may include impairment to respiratory functions, lower tolerance to toxicants or disease, increased physiological stress, decreased reproductive success, and reduced vision, which inhibits their ability to find food. Migrating fish will avoid rivers with high suspended solids concentrations. Reduced light transmission caused by increased turbidity can also reduce primary production (plant growth) in streams, which can have important repercussions on community dynamics (Waters 1995). Spawning and egg incubation periods are particularly sensitive times, because sediment (especially clay and silt) may attach to the adhesive surface of eggs resulting in increased egg mortality (Ward, 1992). Excess sediment discharge to downstream watercourses may also have degradation on water quality, increase stream flooding, elevation levels of in-stream erosion influencing the geomorphic stability/instability of the watercourse channel, and reduce navigation in waterways.

Sediment control measures have been required on construction sites for over a decade. However, even on sites where recommended practices are applied, sediment continues to be discharged at concentrations above those required to protect aquatic life. In one Toronto area study, monitoring of a channel reach upstream and downstream of a construction site showed an average increase in suspended solids concentration of 500%. This increase in stream sediment concentration occurred even though runoff volumes from the construction site comprised less than 25% of total stream flow and sediment control practices were in compliance with interim guidelines (Greenland International and TRCA, 2001). Subsequent studies of temporary sediment control ponds draining construction sites reported similar results (TRCA and U of G, 2006; Clarifica, 2004). During one storm, peak effluent concentrations of suspended solids were over 100 times the target level.

Numerous guideline documents have been prepared since the 1980s, which emphasized the importance of protecting the natural environment during construction activities. Other documents include the technical guidelines produced by the Ministry of Natural Resources (MNR) in 1989. In the years that followed, there have been significant improvements to the application of erosion

and sediment control practices by the construction industry in the GGHA. While these are notable improvements that have effectively improved mitigation of environmental disturbances in construction projects, there have also been many examples of where adequate protection measures for the natural environment have not been diligently applied.

For example, the Ministry of Natural Resources (MNR) 1989 Technical Guideline provided a description of a variety of standard erosion and sediment control measures, which concluded that soil particles greater than 40 microns could be settled out from sediment laden runoff particularly within temporary sediment ponds. Removal of sediment particles less than 40 microns was considered not practical with any of the erosion and sediment control measures utilized at the time. It should be noted that soil particles of less than 40 microns in size are extremely difficult to remove from water once they have been suspended as sediment. However, the effects of the fine grained soil particles can be detrimental to aquatic habitat. Therefore, extra care should be taken to avoid erosion on construction sites, where soils less than 40 microns are found. Based on monitoring of recently designed sediment ponds, clay sized particles less than 4 microns in size can settle out of suspension (TRCA and U of G, 2006).

Field surveys of erosion and sediment control practices on construction sites have revealed a number of serious deficiencies in current planning and implementation (e.g. Greenland and TRCA, 2001). These include:

- The absence of development phasing in which only a portion of the construction site is cleared and graded at any one time;
- Long time lags between soil disturbance and soil stabilization;
- Unnecessary clearing of environmental sensitive areas, such as stream riparian buffers, steep slopes, wetlands and seeps;
- Inadequate maintenance of sediment controls (e.g. sediment ponds, etc.); and,
- Poor field inspection practices and ESC plan enforcement.

This Guideline is intended to help improve the practice of erosion and sediment control, and ensure that a well-defined process is in place to ensure ESC plans are prepared, implemented and enforced.

## **1.2 Guiding Principle**

The pressures of urban development have large scale impacts to the natural environment and in particular aquatic resources and their natural corridors. Changes to the land use can decrease permeability, increase fine sediment inputs, impact on water quality and increase runoff. These changes create an unbalance in the natural processes and lead to increased flood events, reduce base flows, decrease habitat diversity and channel erosion. Sedimentation from construction activities is a major contributor to these problems. This added sediment contributes to the destabilization of watercourses that not only has extreme ecological costs, but results in the loss of property, costly infrastructure repairs and stabilization efforts that could take a lifetime to complete. It is everyone's responsibility to prevent construction related sediment from impacting aquatic resources and other natural features.

## **1.3 The Approach**

An undermined or breached silt fence provides an obvious example of containment problems, but unfortunately, the signs and symptoms revealing more dire threats to sensitive environmental

features remain hidden until the project is well underway or complete. For this reason, all the parties involved, from the earliest assessment stages of a project right through to implementation, must have regard for the natural environment associated with the project. This common understanding of the environmental sensitivities will allow for the collaboration of individuals representing a diverse range of disciplines throughout the lifespan of a project. The outcome of this unified effort will be an effective implementation of erosion and sediment control strategies, an appreciable improvement in the prevention and mitigation of environmental impacts, compliance with regulatory responsibilities and more effective management of the fiscal aspects of the project.

It is important to consider that effective erosion and sediment control must move beyond the installation of devices such as silt fence and move towards an ongoing “process” within a project framework - from conception to construction. This would provide a framework where environmental issues are routinely discussed and addressed through specific design elements, influence on project schedule or navigating constructability issues. Shifting to a dynamic and integrated process of erosion, sediment control and environmental awareness will contribute greatly to eliminating oversights in the protection measures prescribed for the project and ensure adequate and responsible protection of the natural environment. The timely consideration of the environmental constraints will also significantly reduce delays in approval acquisitions, potential for severe environmental mishaps, costly restoration, along with impacts to project schedules and missed deadlines/delivery dates.

The best starting point for any project relating to urban development is to have a clear understanding of the proposed undertaking and the results of the undertaking on the surrounding environment. When an undertaking is clearly defined and the geographic boundaries delineated, a suitable assessment of the environmental features within the project limits can be determined. Environmental assessments tailored to capture the specific undertaking, will provide an understanding of environmental constraints and sensitivities. Such assessments require significant detail within the project to clarify the extent of sensitivities and resulting environmental constraints. Open discussions between the proponent and/or the proponent’s agents and the regulatory agencies should be encouraged to ensure that the proposed level of effort and assessment components are sufficiently detailed to satisfy the approval requirements of the proposed undertaking. This is encouraged for all urban development projects, but should be applied particularly to large-scale, complex projects and those situated in sensitive natural areas.

Construction projects vary widely in type, size and complexity. There is usually a variety of professionals contributing at any stage of the project. Environmental studies including terrestrial, wetland and aquatic issues along with other aspects such as groundwater investigations, geotechnical, fluvial geomorphic and topographic surveys that were completed in support of an undertaking, will form the base of information that can influence the development of the design. In addition, these studies lead to the efficient acquisition of necessary approvals/permits and ultimately provide the operational constraints and details of construction. Skilled and experienced professionals in each represented discipline will consider the implications of the proposed undertaking and offer solutions that ultimately result in an environmentally sound and operational design. It is important to note that the professionals included in the design team often have regulatory agency and/or third party counterparts, who review the proposed undertaking in light of applicable governing legislation and specific interests. These perspectives and design elements are united by the project engineers, who integrate them into the final detail design and approval submission. Included as an integral part of the submission and a key component of this Guideline is an erosion and sediment control plan that has been developed by combining environmental site

conditions with all the construction elements required for an undertaking. The end product is an effective erosion and sediment control strategy.

#### **1.4 The Focus**

The following sections of this document are intended to provide proponents and practitioners with a review of erosion and sedimentation processes; an overview of the current regulatory framework in which these undertakings are reviewed; clarify the roles and responsibilities of those involved in the construction process; identify the elements of an effective erosion and sediment control plan and offer methods of the current erosion and sediment control measures routinely employed to protect natural environments within an urban construction project. The implementation of the developed erosion and sediment control plan including inspection and maintenance will also be addressed.

The Guideline will expand on methods to prevent erosion and minimize sediment transport through the multi barrier approach, create dynamic ESC plans, and improved inspection, monitoring and maintenance protocols. Easy reference tools such as tables and charts will enable all users of this guideline to make the appropriate decision, when preparing and implementing an ESC Plan within the GGHA.

#### **1.5 The Purpose**

The uniqueness of each construction project challenges the land owners, developers, builders, contractors, consultants, municipalities and regulatory agencies (conservation authorities, municipal, provincial, federal) to remain knowledgeable of the most current erosion and sediment control measures. In concert, those approaches with technologies currently in use must be critically evaluated for applicability and effectiveness. The effort to remain aware of new controls and installations improves the overall long-term performance of the ESC measures and provides protection for the environment.

It is the intent of this document to provide sufficient information to assist all parties in the prevention of erosion during the construction process, including dealing with suspended sediment at the source and minimizing sediment transport from leaving the construction site. Stringent inspections, monitoring, maintenance, and reporting protocols combined with improved installation methods and design improvements through the use of new technologies and combination of existing ESC measures will ensure an improvement to the overall performance of ESC measures.

The recommendations in this document are related to erosion and sediment control at urban construction sites within the GGHA, and it should be noted that this document does not release the proponent or practitioner from responsibility for obtaining any other permits, approvals or authorizations required under federal, provincial or municipal legislations for any aspects of their plan, work, undertaking, or activity.

The Guideline is intended to fulfill the following needs:

- Provide a consolidated statement of Regulatory requirements and expectation regarding ESC;
- Clarify the respective roles and responsibilities for all Regulatory agencies, land owners, developers, builders, contractors and consultants;

- Encourage awareness of and conformance with federal and provincial legislation and with municipal by-laws, permits and standards related to ESC;
- Improve communications among all parties responsible for ESC;
- Assist parties in recognizing the causes of environmental damage and the various means of mitigating the risks, thereby reducing the environmental impacts; and,
- Promote consistency, quality and continual improvement in the standard of efforts to protect the environment

**For additional information on erosion and sediment control specifically for road improvement projects, it is suggested that the National Guide to Erosion and Sediment Control on Roadway Projects, May 2005, Transportation Association of Canada (TAC) be referenced.**

The TAC document can be obtained via:

Internet: TAC online bookstore: [www.tac-atc.ca/english/projectsandpublications/bookstore.cfm](http://www.tac-atc.ca/english/projectsandpublications/bookstore.cfm)

Email: [publications@tac-atc.ca](mailto:publications@tac-atc.ca)

Mail: Publications Department, Transportation Association of Canada  
2323 St. Laurent Blvd.  
Ottawa, ON, K1G 4J8

Telephone: Monday to Friday from 8:00am to 4:00pm  
613.736-1350 ext. 221

This is a “living document” and will be updated periodically as new technologies and installation methods are tested and approved. All users of this Guideline should ensure the most up to date edition of the Guideline is utilized. The local Conservation Authority should be contacted to obtain the most up to date ESC Guideline.

Currently, the most up to date Erosion and Sediment Control Guideline can be found on the *Sustainable Technologies Evaluation Program (STEP)* website – [www.sustainabletechnologies.ca](http://www.sustainabletechnologies.ca).

## 2.0 Erosion and Sedimentation Processes

Erosion and sedimentation are naturally occurring processes that involve particle detachment, sediment transport and deposition of soil particles. Construction activities commonly alter the landscapes where they are located, exacerbating these natural processes. One of the most significant alterations encountered during construction is the removal of the vegetation that stabilizes the subsoil. In the absence of the vegetation, the underlying soils are fully or partially exposed to various natural forces such as rain, flowing water, wind, and gravity.

For the purpose of this guideline, **erosion** is defined as the physical removal or detachment of soil materials. The subsequent transport and deposition of these detached particles (sediment) from the source location by the action of a mobile agent is referred to as **sedimentation**. This guideline will address two common mobile agents: water and wind. The factors that influence the type and severity of erosion include vegetation cover, topography, soil erodibility/permeability and precipitation.

The transport of sediment overland and deposition into surrounding natural areas, including watercourses (fish habitat), woodlots and wetlands as well as adjacent private lands, needs to be prevented. The consequence of off-site movement of sediment from a construction site varies with the characteristics of the drainage pathways and the final area of deposition. In the case where the sediment is transported downstream through a watercourse, there can be significant negative affects to fish habitat, floodplains, water supplies, infrastructure, flood control, navigation and recreational activities.

Clearly, the best way to prevent sedimentation is to prevent erosion. This fundamental truth is the reason to understand the erosion potential of a site at every project stage. **Appendix A** lists the Ministry of Natural Resources Erosion Potential Reference Charts. In cases where the surrounding environmental features are sensitive, erosion control efforts should be effective and significantly constrain the approach to an undertaking including controlled vegetation clearing, which is usually conducted in phases and the utilization of unobtrusive construction methodologies. **Erosion prevention is the preferred mitigation measure for eliminating and/or reducing the potential for sedimentation.**

Understanding the influences that topography has on a site begins with an assumption that the larger the project area, the greater the disturbed surface area and consequently, the greater the influence that precipitation and resulting runoff has on a site. Topography is one of the factors that directs runoff and increases velocity and erosion rates. Where steep slopes are found within a project boundary, runoff may be accelerated down slope to receiving features such as watercourse, wetlands, swales and woodlots. In the absence of surface roughness both through the lack of vegetation or loose permeable surfaces, runoff velocities will be accelerated by gravity and the ability to attenuate storm events will be compromised. These conditions make the control of sediment nearly unattainable without significant planning, an effective sediment control strategy, contingencies, exhaustive maintenance, and costly restoration. Particular care should be taken when undertakings involve interconnected projects that mainly consist of construction activities on the landscape. The resulting overlap of large project areas with construction activities on the landscape can expose expansive tracts of land to construction related disturbances, thereby increasing the potential for environmental impacts. This concentration of construction can greatly influence the severity of the impacts to receiving natural features.

The ease at which soil particles come apart by water or wind is considered a measure of erodibility. The cohesiveness of a soil allows it to resist against the erosive forces acting against



the surface, such as demonstrated with most clays and compacted tills. Less cohesive particles like silt and fine sands not only come apart easily by water, but they also represent the characteristics of most containment methods. The small size of these particles challenges effective filtration by standard control measures. Filtration is the process of sediment laden water passing through a medium (e.g. geotextile, sand) with small voids. These small voids trap the targeted size range of sediment. The length of time these particles remain suspended is considerable and an extended detention time is required to allow for particle settlement. Settlement of the suspended soil particles occurs when the kinetic energy of the moving water is no longer sufficient enough to carry these particles against the forces of gravity and friction. When in motion, the suspension time of the particles in the sediment laden water is magnified and in the absence of containment could travel greater distances, which will amplify the environmental impacts.

Increasing runoff velocities allow for the detachment and transport of proportionately larger particle sizes. Large particles, such as gravel and coarse sand, settle out from the flow first. This is primarily encouraged through the use of containment measures, flow restrictions and velocity controls. These are often used in conjunction with a level of filtration. As noted above, smaller particles such as fine sands, silt, and clay-sized fractions require extended detention to be removed from suspension. Extended detention is the process of allowing the suspended solids to settle, through detaining the sediment laden water for a period of time within a basin such as a temporary sediment pond or storage container. There is usually a controlled outflow release rate for the containment method that allows for this extended time. In some cases a chemical flocculent can be introduced that reacts with suspended sediment and encourages their settlement, filtration and retention. This process of coagulation and flocculation allows for the settling out of very small soil particles.

To help maintain the cohesiveness of underlying soils and reduce runoff velocities, vegetation cover should be maintained to provide necessary roughness. Staging and scheduling of both construction activities and restoration efforts are pre-requisites for this preferred method of erosion control. Buffer strips between an undertaking and surrounding natural areas are often part of erosion control and in some cases a recommendation of some approvals. The extent of these vegetated areas needs to be protected fully from construction impacts, unless previously approved for such cases as with some dewatering operations. Vehicular traffic within a construction site should also be restricted to ensure that disturbances from machinery are controlled.

For underlying soils exposed through vegetation removal or excavation, alternative erosion prevention measures should be implemented where practical. Steps should be taken to reduce runoff volumes.

Once the soil particles have been suspended by water and begin to move off-site, the true challenges of sediment control begin. With measures being taken to prevent erosion and reduce runoff volumes, the next efforts are dedicated to containing active work areas including in-stream construction activities and dewatering operations from land based operations, such as the discharged water from pumping operations. Containment of the construction site is achieved through the use of sediment controls.

As mentioned above, erosion and sedimentation are naturally occurring processes that involve particle detachment, sediment transport and deposition of soil particles. These natural processes are connected to urban construction projects through a number of avenues. If construction activities are not effectively mitigated and contained, the exacerbation of these processes can contribute a significant amount of sediment to downstream watercourses. While it is true that

sediment is transported naturally in most watercourses as “bedload”, artificial inputs from construction can upset the natural balance of bedload distribution.

The discharge of high sediment loads to natural watercourses has major effects on receiving waters and aquatic habitat. Some specific examples include:

- Degradation of water quality;
- Damage or destruction of fish habitat;
- Increased flooding;
- Elevated levels of in-stream erosion influencing the geomorphic stability/instability of the watercourse channel (channel width and depth as well as riffle and pool characteristics); and,
- Reduced navigation in waterways (aggradations).

Silt and sediment deposits and elevated levels of turbidity can cause a variety of harmful impacts to fish and fish habitat (DFO *et al.*, 2003) by contributing to the following:

- Reducing the diversity and abundance of bottom-dwelling organisms that fish feed upon;
- Blanketing spawning substrates such that they may not be suitable for spawning or food production;
- Reducing the survival of fish eggs by smothering the spawning beds and preventing the escape of hatching fry;
- Destroying aquatic vegetation that is buried by sediments;
- Clogging fish gills and damaging gill membranes; and
- Reducing the ability of fish to feed by sight.

The costs associated with the impacts of erosion and sedimentation both on and off construction sites can be quite significant. The costs can be more severe if critical elements have been missed in the design process and/or the identification of effective erosion control and sediment containment is implemented only after a significant environmental mishap has occurred. Consequently, there are even greater costs to a project that can be incurred for a development to address the impacts of erosion and sedimentation.

The costs associated with the impacts of erosion and sedimentation include, but are not limited to:

- Removal of sediment;
- Repair and stabilization of slopes and channels;
- Construction delays and stop-work orders;
- Charges and fines; and,
- Construction of new ecosystem habitat.

### 3.0 Regulations – Federal, Provincial, Municipal, and Conservation Authorities

There are extensive environmental legislations and regulations that have been enacted to guide construction activities away from natural environment impacts. It is from within these regulatory boundaries that a construction project must be considered at the beginning through to completion. Understanding the regulatory environment in which an undertaking is developed and implemented is critical in ensuring that every effort is made to acquire and comply with all the necessary approvals and permits.

The potential consequences of non-compliance with any such applicable legislation are extensive. These might include, but are not limited to:

- Increased regulatory scrutiny;
- Tarnished professional reputations;
- Construction shutdowns;
- Costs of additional assessments/restoration;
- Substantial legal costs;
- Monetary fines;
- Relinquished work permits; and/or,
- Imprisonment – in some cases.

It is important to note that the specific details provided below are not meant to be exhaustive as the intricacies of each undertaking are matched equally to the regulatory requirements. It is highly recommended that practitioners familiarize themselves with the specific details of all applicable legislations.

References to the Federal and Provincial legislations, Municipal bylaws and *Conservation Authorities Act* discussed in this Guideline are found in **Appendix B**. The Acts and By-Laws pertaining to erosion and sediment control are not limited to those listed in this Guideline.

#### 3.1 Federal

The *Federal Fisheries Act* applies to urban construction activities in two primary ways: fish habitat and deleterious substance. The Act requires that fish and fish habitat are protected during all stages of construction. Commonly, undertakings will intrude into this realm where there is:

- Realignment or intrusion into a stream channel;
- Restrictions to fluvial processes;
- Impacts to riparian corridors;
- Infilling of lacustrine habitats, wetlands and coastal marshes;
- Channelizing and piping headwater inputs;
- Inputs of substances from construction deemed deleterious (harmful) to aquatic life; and,
- Dewatering operations.

The Fisheries Act Applies to all Canadian waters (public or private) that provide fish habitat or support fish habitat opportunities at any life stage and is intended to conserve and protect fish and

these habitats. This Act applies both to permanently wetted areas and those habitat features that are intermittently wetted. In addition to the naturally occurring fish habitat, this Act also may include manmade features. Through this legislation, management of physical, chemical and biological attributes, which are required by fish to carry out their life processes, can occur.

Two critical definitions within the Fisheries Act include:

**Fish** (S. 21): Parts of a fish; shellfish, crustaceans, marine animals and any parts of shellfish, crustaceans or marine animals; and the eggs, sperm, spawn, larvae, spat and juvenile stages of fish, shellfish, crustaceans and marine animals.

**Fish Habitat** (S. 34): Spawning grounds and the nursery, rearing, food supply and migration area on which fish depend directly or indirectly in order to carry out their life processes.

Of specific interest to some undertakings, the Fisheries Act prohibits obstructions to fish passage (S.29), destruction of fish unless authorized (S.32), and prohibits the intentional or unintentional release of deleterious substances (S.36). Defined in the act as:

**Deleterious Substance** (S.34): A substance or water containing a substance that degrades or alters water quality to the detriment of fish, fish habitat or use by man of fish found in the receiving water.

This can in many instances include construction related sedimentation. It should be understood that there can be no Authorization secured that allows for the release of a deleterious substance. It is also the responsibility of the party that owns the substance to report any release.

When an undertaking has the potential to impact on any of the constraints detailed in the Act, Fisheries and Oceans Canada – Ontario – Great Lakes area (DFO) is the governing agency that is consulted and who is ultimately responsible for issuing the binding Authorizations that are required to operate within this legal framework of the Fisheries Act. They are mandated to provide habitat conservation and protection.

Fisheries Act Authorizations allow for the “harmful alteration, disruption or destruction of fish habitat” or HADD (S.35). Authorizations are provided for a project when a proponent develops an appropriate mitigation and compensation strategy that is ultimately accepted by DFO. DFO requires that the proponent provide design details of the undertaking including the specifics of the mitigation and compensation agreement (S.37). These plans must be compliant with the intent of the Act and are legally binding components of an Authorization. Conservation Authorities provide a hub for the screening of the proposed undertakings. Building from this initial role, there is a hierarchy of agreements negotiated between DFO and the Authorities that allow for an increasing level of responsibility. At the highest level, the Conservation Authorities, as agents, can fully negotiate the mitigation/compensation measures as well as monitoring programs, review the design details and draft the Authorization. Through internal process DFO is kept aware of the particulars of the undertakings under review and upon receipt of the final plans, formally issue the Authorization.

In addition to Authorizations, DFO can issue a Letter of Advice regarding a particular undertaking that essentially acknowledges awareness of the undertaking and allows the proponent to proceed without the requirement of an Authorization with the caveat that the provisions detailed in the Letter are respected and all other permits secured.

In order to ensure compliance with the Fisheries Act, Fishery Officers and other DFO designates have the power of inspection and can direct works through an Inspector's Direction Order (S.38). With these powers, compliance with the conditions of the Authorization can be determined at any time at any location through site inspections.

Contraventions of Sections 35(1) and 36(3) include the following offences:

- Releasing or depositing deleterious substances (including sediment);
- Failing to report the release or deposit; and/or,
- Failing to mitigate or restore.

The ***Navigable Waters Protection Act*** (NWPA) is a federal statute that regulates a broad range of works that affect navigable waters. These coastal and inland waters are considered any body of water capable of being navigated by floating vessels of any description for the purpose of transportation, commerce or recreation. The provisions of this Act are meant to ensure the public right of passage on Canadian Waterways.

The NWPA would apply essentially to undertakings (structures, devices or things) that may interfere with navigation. Included in this would be any bridges, dams, pipelines, tunnels, power cables, docks and weirs. Also encompassed in this Act is the infilling of navigable waters or the removal of materials from the bed of navigable waters. Transport Canada is responsible to administer the Act.

The ***Canadian Environmental Assessment Act*** (CEAA) is the jurisdiction of the Canadian Environmental Agency, whose interest is to ensure environmental effects are identified and mitigated wherever possible. Not unlike the approach presented in the Guiding Principle (Section 1.2) of this Guideline, an objective of CEAA is to ensure that identification and assessment of environmental effects leads to the development of effective mitigation through the prescribed planning process. This process allows for the review of undertakings by other regulatory agencies and a decision is made on whether to let the project proceed. These agencies may include the Canadian Wildlife Service, Environment Canada, Ministry of the Environment, Ministry of Natural Resources and local governing bodies. This examination is intended to evaluate the environmental effects and proposed mitigation measures. There is an opportunity through this process for the prescription of conditions and provisions in other agency approvals. CEAA can be triggered for a range of public and private projects that are under review by other federal agencies such as DFO, Canadian Coast Guard, Transport Canada, as well as by projects fully or partially funded by federal reserves. Projects located on or potentially affecting Aboriginal lands are also a trigger of the CEAA review process. Approval through a CEAA review is directly tied to the release of all the federal permits, Authorizations and the approvals of all regulatory agencies.

Other federal legislation to be aware of include the Migratory Birds Convention Act, Endangered Species Act, Environmental Protection Act and the Canadian Wildlife Act.

The ***Species at Risk Act*** is expected to have an increasing effect on every stage of a construction project and in particular during the assessment stages. With a growing understanding of the distribution and biology of these species, operational constraints during construction will likely be more restrictive and the requirements for post construction monitoring will be extensive.

### 3.2 Provincial

The Ministry of Natural Resources (MNR) is the regulatory agency for a number of provincial acts and legislations that could apply to some undertakings. The *Lakes and Rivers Act*, *Provincial Policy Statements* and *Planning Acts* can influence undertakings both during the development and completion of a project.

The Ministry of the Environment (MOE) is responsible for administering the *Ontario Water Resources Act* (OWRA). The purpose of the OWRA is to protect and manage the quality and quantity of surface and ground water. The OWRA prohibits discharging or depositing material in any water or on any bank that may degrade the quality of surface water such as rivers and streams (s.30). The Act also establishes an approval regime (S.30-33). This is generally encountered when there is a requirement for stormwater management associated with an undertaking. In this case it is recommended that the “Stormwater Management Planning and Design Manual, March 2003” be referenced.

The *Oak Ridges Moraine Conservation Plan Act* protects the ecological and hydrological integrity of the Oak Ridges Moraine Area. The purpose of the Oak Ridges Moraine Conservation Plan Act is to provide land use and resource management planning direction to provincial ministers, ministries (and agencies), municipalities, municipal planning authorities, landowners, and other stakeholders on how to protect the Moraine's ecological and hydrological features and functions.

Other provincial legislation to be aware of include the Permit To Take Water, Source Water Protection Act, and the Environmental Protection Act.

### 3.3 Conservation Authority and Municipal

Among their other roles, Conservation Authority staff are also involved with the technical review of erosion and sediment controls related to their regulations for construction activities or developments that interfere with wetlands, or alter floodplain and watercourse channels. Also, many Conservation Authorities (CAs) in the GGHA have entered into a memorandum of understanding (MOU) with their member municipalities. These MOUs, allow CA staff to review and provide comments and recommendations regarding site plan and subdivision plans and agreements with regards to stormwater management (water quality and quantity controls), watercourse and floodplain form and function, and overall area or site based ESC. However, the respective municipal staff will still maintain the lead role in approving ESC plans.

ESC plan review is conducted through the application process under the provisions of the Section 28 Regulations of the GGHA CAs. All conservation authorities in the province of Ontario administer a **Development, Interference with Wetlands and Alterations to Shorelines and Watercourses Regulation** under Section 28(1) of the *Conservation Authorities Act* (CAA). The areas regulated by a conservation authority are defined in the written text of their individual Regulation. Mapping of these regulated areas is typically used by the conservation authority to assist with the implementation of their Regulation. A permit from the local conservation authority is required for the straightening, changing, diverting or interfering in any way with the existing channel of a river, creek, stream or watercourse, or for changing or interfering in any way with a wetland; and for development within regulated areas if, in the opinion of the authority, the control of flooding, erosion, dynamic beaches or pollution or the conservation of land may be affected by the development. Development activities include the construction, reconstruction, erection or placing of a building or structure of any kind; any change to a building or structure that would



have the effect of altering the use or potential use of the building or structure, increasing the size of the building or structure or increasing the number of dwelling units in the building or structure; site grading, or the temporary or permanent placing, dumping or removal of any material, originating on the site or elsewhere.

The **Planning Act** authorizes municipalities to pass “Sediment and Erosion Control” Bylaws (S.142) that regulate activities and undertakings that disturb the natural ground conditions and alter soil sediment distribution (S. O. 2001, Chapter 25). This section is comprehensive and proactive in controlling land-disturbing activities early in the development process. Bylaws require permits to be secured for site alterations that routinely require environmental assessments and as a condition of approval erosion and sediment control plan and/or Environmental Control Plan. Additional requirements of the Planning Act may also control tree removal, maintenance of buffers, stormwater management, and restoration components. The applicable requirements of the Planning Act vary with both the jurisdiction and specifics of the undertakings and usually reveal themselves during the planning process.

Each municipality has its own process to allow earthworks and the construction process to be initiated either through a top soil bylaw, tree removal bylaw, site alteration permit or pre-servicing agreements. The ESC plan forms a key component of this process and the land owner is required to meet the conditions of the identified municipal approval process. The conditions of the approval generally include a letter of credit for a predetermined percentage of the cost to implement, maintain and decommission the ESC plan. Below is an example of wording that can be included in the municipal process to ensure the ESC devices are properly maintained throughout the development process:

*“The Developer shall take the necessary precautions to prevent erosion and sedimentation of sewers, ditches, watercourses, culverts, slopes and other related features both within the plan and down gradient from the plan during and after the completion of construction. The Developer will be responsible for maintaining the erosion and sedimentation controls until assumption of the subdivision by the Municipality, correcting any damage, or paying the costs of same, caused by failing to take proper control measures. One hundred percent of the Erosion and Sediment control securities will be released to the developer/owner(s) at the time of subdivision assumption, provided the ESC measure(s) functioned according to plan and that all additional maintenance was provided by the owner.”*

## 4.0 Key Participants Roles and Responsibilities

The approach to the protection of the environment during construction requires that every person shares in the responsibility for that overall success. The extent of that responsibility is allocated to participants according to their respective roles. It is important not to forget that significant environmental mishaps can be tied to an event as simple as refuelling a bypass pump. Often critical responsibilities are held in the hands of the construction worker. This should highlight the importance of shared responsibility. This responsibility can be shared effectively through environmental awareness, training, quality control/assurance and compliance monitoring.

**Table 1** summarizes the roles and responsibilities of each participant in the ESC process. Provisions from federal and provincial regulations, as well as municipal by-laws, enforce these responsibilities. The local municipality in coordination with the local Conservation Authority are generally the lead agencies in reviewing the proposed ESC plan and inspecting the initial installation of the ESC measures implemented for a construction site within their jurisdiction. Other agencies will become involved in the review and/or enforcement of ESC practices, if site conditions and/or construction activities are applicable under their respective legislation or regulations.

With an accepted level of responsibility, consideration must be given to the two often overlapping components: personal/professional responsibilities and legal liability. One of the most difficult messages to convey is the individual connection that we all have when involved in this process. This is due in part to its' intrinsic nature and the ways that each person respects their role with regard to the environment. Often this is personally measured against competing influences such as preconceived ideas, attitude, time and money. It can be demonstrated through project experience that increased environmental awareness can result in a better and more predictable "bottom line" while protecting resources. This awareness can be enhanced through construction experience, education/training and willingness. This Guideline intends to promote this awareness and provide an avenue for education. It is expected that this benefit will be immediately realized by those attending specific training sessions. It is also anticipated that this message will be emphasized in future undertakings and received by other project contributors.

As professionals, affiliation, accreditation and certification is sought through a variety of governing bodies and Associations such as the Professional Engineers of Ontario (PEO), Ontario Association of Certified Engineering Technicians and Technologists (OACETT), and Association of Professional Geoscientists of Ontario (APGO). Many of these organizations have codes of professional conduct and ethics that are relevant to environmental protection. The specifics should be researched by those encompassed by these groups.

Legal liability, as it relates to environmental protection, is directly tied to the specifics of the applicable regulations and laws in both secured permits, approvals and Authorizations as well as in action. Compliance with these constraints is often measured through demonstration of "**due diligence**".

Due Diligence can be defined as:

Such a measure of prudence, activity, or assiduity, as is properly to be expected from, and ordinarily exercised by, a reasonable and prudent person under the particular circumstances; not measured by any absolute standard, but depending on the relative facts of the special case. (Blacks Legal Dictionary)

Due diligence is also simply being able to demonstrate that every reasonable effort was made to ensure compliance. Compliance or the exercise of due diligence is determined through investigations and audits by regulatory agencies and/or independent parties.

Ultimately, the burden of erosion and sediment control is the responsibility of the owners or proponents of the undertaking because they are the parties driving the project and the potential environmental impacts. From this point, the partitioning of individual responsibility can commence. Logically, the owner shares liability for the undertaking with the professionals retained to manage the undertaking on their behalf. This responsibility is delegated within the project team and ultimately carried to the site level or construction phase by Contract Administrators, Contractors and Compliance Monitors.

Due diligence is strengthened throughout the design process and demonstrated on the ground during construction through an effective and practical erosion and sediment control approach. The protection of the environment and project success will be the proof of compliance. The execution of an undertaking is never that simple and the reality is “things” do happen. The next test of due diligence is whether or not those “things” were foreseeable, preventable and ultimately in whether the required action was conducted in a reasonable and timely manner. This level of protection is typically limited to the events surrounding construction and is enforced through “on the ground” inspections and environmental compliance monitoring.

Numerous individuals comprise the layers of quality control/assurance inspectors and monitors during construction. For the purposes of this Guideline, the construction team is comprised of members representing various specialties and interests similar to those utilized during the design stage of the project. The roles of these individuals should be established prior to construction and have developed communication protocols that include the owner, key participants and the regulatory agencies as required. The strength of an erosion and sediment control plan often lies with a thorough understanding of the undertaking. This comprehension is normally found in the Contract Administrator (Administrator) who forms the core of the construction team. The Administrator is traditionally the owner’s representative on the project who liaises with all parties including the constructor and review agencies. Added professionals/inspectors involved in construction can usually be divided into those who work on behalf of the owner or those employed by the constructor. Roles in this regard are sometimes duplicated. The Administrator provides construction specifics and schedules to the rest of the team who assess the construction details and makes recommendations for the specialty. Notably, the team size expands and contracts in response to project progress where specific expertise is needed. Effective construction teams recognize the need for additional expertise and rapidly engage those services to allow the most time for design input.

One key role that can often be played by an individual throughout an entire construction project is that of the Environmental Monitor (EM). The EM role is that generally of an environmental professional who assumes a quality control/assurance focus as it relates to environmental compliance. These individuals should have demonstrated ability and experience overseeing the environmental intricacies of an undertaking. This role should include an understanding of environmental impacts relating to construction activities, an awareness of the regulatory context of a project (permits and approvals), a working knowledge of the undertaking as it relates to the environment and be intimately familiar with the erosion and sediment control plan. During construction the environmental monitor can provide practical advice on environmental management which can protect the project/owner from unnecessary environmental risk and potential liabilities. Among the other broad range of roles assumed, the EM can also play an integral role in the event of a mishap. This can involve the coordination of event reporting,

development of containment measures, creation of restoration plans as well as forming a communication bridge between the site participants and the regulatory agency representatives/enforcement officers. The boundaries of the EM role are developed based on the environmental sensitivities, experience level, construction specifics and solidified in the working agreement/contract negotiated between the EM and the employer (owner/contractor/agency).

Additional personnel may be required for an undertaking to conduct specific tasks and are referred to as Construction Specialists. These potential participants of the construction team can include fluvial geomorphologist, geotechnical engineers, hydrogeologists and product/service representatives.

**Table 1. Roles and Responsibilities of Involved Parties**

Party	Roles and Responsibilities
Land Owner, Developer, Builder	<ul style="list-style-type: none"> <li>▪ Ultimate responsibility for ESC planning, design, implementation, inspection, monitoring, maintenance, operation, and decommissioning.</li> <li>▪ May delegate this responsibility to numerous design and construction professionals to construct/implement, maintain and inspect /monitor for the duration of the undertaking.</li> <li>▪ Signs agreements, approvals permits and Authorizations to which compliance is legally binding</li> <li>▪ Ultimately responsible for the proper planning, design, implementation of a project and specifically the execution of an ESC Plan.</li> <li>▪ Ensure constructors have copies of all pertinent approvals and permits as well as the details of an ESC Plan,</li> <li>▪ Ensure contractors are aware of their responsibilities and are back charged for construction of ESC measures installed, maintained and specific restorations requirements.</li> <li>▪ Liable for failure of ESC or regulatory violation.</li> <li>▪ Participate in every step of ESC process.</li> </ul>
Project Manager/ Design Engineers/ Sub-consultants/Specialties	<ul style="list-style-type: none"> <li>▪ Provide accurate and applicable impact assessment and design details which considers the potential for environmental effects</li> <li>▪ Assist ESC Plan designer in planning ESC as it relates to construction phases, schedules and local sensitivities including soil conditions, vegetation, and public safety.</li> <li>▪ Maintain awareness of consequences regarding ESC failures from a regulatory perspective and maintain ongoing contact with Owner.</li> <li>▪ Aware of contingency Plan and direct use when/if necessary.</li> </ul>
Erosion and Sediment Control (ESC) Plan Designer	<ul style="list-style-type: none"> <li>▪ Lead the development of the ESC Plan.</li> <li>▪ Select and design ESC practices that suit the construction site/ environmental conditions.</li> <li>▪ Visit site before designing the Plan and during its implementation.</li> <li>▪ Review and approve of on-site design modifications.</li> <li>▪ Develop contingency Plan for problems.</li> <li>▪ Implement contingency Plan if warranted.</li> <li>▪ Ensure inspection services are provided for the duration of the four phase construction process and stabilization period.</li> <li>▪ Responsible for all four phases of construction process. Assigns personnel to inspect/monitor approved Plan throughout the construction process.</li> </ul>
Contract Administrator	<ul style="list-style-type: none"> <li>▪ Traditionally owner's representative.</li> <li>▪ Forms core of construction team.</li> <li>▪ Provides construction specifics and schedules to rest of construction team.</li> <li>▪ Liases with all parties including constructor and agencies, and</li> <li>▪ Makes recommendations for the requirement of Specialists.</li> </ul>

**Table 1. Roles and Responsibilities of Involved Parties**

Party	Roles and Responsibilities
Environmental Monitor (EM)	<ul style="list-style-type: none"> <li>▪ Understand the ESC Plan and construction methods.</li> <li>▪ Inform ESC Plan designer about any changes to the construction phases and schedules.</li> <li>▪ Recognizes the effective applications of ESC measures and communicates recommendations with contractor and Municipal Inspector.</li> <li>▪ Inspects all ESC measures every seven days and after all rainfall event and/or significant snowmelts.</li> <li>▪ Be aware of contingency plan and direct use when/if necessary</li> <li>▪ Provide feedback to contractor.</li> <li>▪ Keep track of construction phase modifications.</li> <li>▪ Document site inspections and corrective actions.</li> <li>▪ Maintain log books – records from weekly/event based inspections.</li> </ul>
Contractor	<ul style="list-style-type: none"> <li>▪ Controls the implementation and effectiveness of ESC Plan.</li> <li>▪ Install the ESC measures as per specification.</li> <li>▪ Communicate with CA and site inspector of any failure of the control measure.</li> <li>▪ Should communicate with Inspector and ESC Plan designer concerns with ESC practice and on-site condition.</li> <li>▪ Vigilant for operation and maintenance of ESC measures.</li> <li>▪ Respond promptly to feedback from site inspector, regulator, or project manager.</li> </ul>
Regulatory Agencies	<ul style="list-style-type: none"> <li>▪ Establish guidelines and updates as required.</li> <li>▪ Enforce the laws under the federal, provincial legislation and municipal by-laws.</li> <li>▪ Performance evaluation monitoring.</li> <li>▪ Should clearly communicate the submission requirements such as ESC Plan and Letter of Credit.</li> <li>▪ Review plans and provide comments/directions to EM.</li> <li>▪ Provide training workshops.</li> </ul>

## **5.0 Environmental Management**

Environmental management is the product of the planning and design of an undertaking related to the mitigation of environmental effect. Components of this environmental management are visible in various forms including permits, approvals, tender documents, design drawings, operational standards and restoration plans which are interwoven into the project. An important function of environmental management is to translate all the operational constraints, mitigation, compensation and restoration measures detailed in the approvals package to the construction operations.

Environmental management can include specific elements including:

- Erosion and Sediment Control (ESC) Plans;
- Worksite isolation plans for in-stream construction; and,
- Spill Control and Response Plans.

The plans should encompass all elements of an undertaking and provide a substantial measure of diligence if the site-specific details have been incorporated.

### **5.1 Environmental Management Details for Erosion and Sediment Control Consideration**

Periodic reconnaissance visits before construction will allow for the identification of environmental management details. This is due in part to the fact that there could be a number of years between the design, approval and implementation of a project. A number of changes can occur during these periods that can affect construction and in urban areas this could involve other development projects. Watercourse characteristics can also significantly change in a small period of time due to erosion and depositional forces. These changes can be even more pronounced in an urban environment and can significantly impact on in-stream construction. A common verification activity is updating critical ground elevations, watercourse details (top of bank, wetted edge, and longitudinal profiles) and location information such as limits of existing vegetation, underground/overhead services, property lines and working easements.

When the design gets handed over to the construction team many parties may be looking at the site for the first time. This early visit should be considered mandatory for all construction participants and is often satisfied during the formal pre-construction meeting. The importance of time on a project should be the driving factor to gain site familiarity as soon as possible. Constructability and approval compliance issues can be identified before construction begins allowing for conflict resolution. Photographic records of the site should be taken at all stages of construction with particular focus on environmental features, private property and other infrastructure.

The site-specific details commonly considered during the development of an ESC Plan such as environmental features have been identified early in the process. Environmental features such as wetlands, riparian corridors, woodlots and watercourses have been assigned a suite of protection measures driven by layers of regulations and permitting. These features should be well buffered by layers of erosion protection and sediment containment measures. In addition, contingency plans are often developed to cope with “worst case” scenarios relating to these features that are envisioned as a potential. These plans should be continually developed to respond to changing site conditions.



The characteristics of these natural features will also provide insight into the topography of the site. For example: the topography for a valley will usually be steep as the slopes of a valley wall leading down to a watercourse are steep, and the topography for a low lying area of a wetland will be gentle. The specific prescription of mitigation measures will vary according to the potential threats of construction. In many cases this will involve a setback from the top-of-bank or established wetland boundary that remains undisturbed. This may guard against geotechnical concerns as well as the erosion potential of steeper slopes. Undertakings often result in significant changes to topography and drainage pathways through fill placement or re-grading. Particular care should be given to specific erosion and sediment control measures that protect during each stage of the construction process. Topsoil stripping should be conducted in a logical sequence in order to minimize the areas where soil is exposed. Topsoil removal should be organized and timed according to the schedule for grading and development works within the overall property. In many instances bulk earthworks cut/fill operations follow immediately after topsoil stripping and it is necessary to strip all topsoil. Information on topography can be obtained through existing topographic mapping, aerial photography and terrain modelling. At a minimum the scale of the mapping should be at least 1:2000, and should provide at minimum 0.5-metre contour intervals to illustrate adequate drawing details although many new technologies allow for much greater resolution (0.1-metre contours). These same sources will identify general drainage direction and existing pathways.

Environmental features are indicators of other important site-specific characteristics. The potential for groundwater interference can be anticipated if there is a deep excavation near a wetland. Borehole logs, geological mapping and other relevant data should be collected and reviewed to predict the risks. Consider an undertaking with requirements for deep excavations adjacent to a Provincially Significant wetland classified in part because of groundwater influences. In this case, a Permit To Take Water (PTTW) from the Ministry of Environment may be required. The need for this permit is driven by a number of factors including the duration and rate of pumping anticipated. This permit can be tied to a monitoring program to ensure compliance. This may include monitoring of biological components, as well as groundwater levels through borehole monitoring, mini piezometers and residential wells. Permits conditions may also stipulate the monitoring of the release waters from this operation which have an acceptable range of critical chemical parameters (temperature, turbidity).

Closely tied to the groundwater conditions of a site is the underlying soil and geological conditions. Through the review of test pit and bore hole logs the soil conditions and a measure of erodibility can also be predicted. This review should provide details on moisture content, particle size and structure, as well as compactness. Particular attention should be given to the soil conditions that are affected by the undertaking such as at the elevations of excavations not just the surficial conditions. Knowledge and understanding of the type of soil present on a site and its particular erosion and sedimentation “qualities” is essential to developing an appropriate ESC Plan. **Appendix A** contains reference charts for aid in determining the susceptibility of a range of different soil types to the forces of erosion.

## 6.0 Developing an Effective Erosion and Sediment Control Plan

Designing and implementing an effective Erosion and Sediment Control (ESC) Plan is essential for minimizing the potentially adverse environmental effects originating from a construction site. A good ESC plan should use a multi barrier approach which includes two key elements: prevent erosion during the construction process to deal with suspended sediment at the source and minimize sediment transport from leaving the construction site. The ESC Plan requires the following steps to ensure that a practical design is chosen and effectively implemented:

- The multi barrier approach should be considered when designing the ESC Plan. Improved installation methods and design improvements of new technologies must be considered along with traditional ESC measures; and,
- The ESC mitigation measures must be installed correctly.

The mitigation measures must be maintained through regular inspections, monitoring, and maintenance until the soil has been stabilized. Reporting protocols should be used to document the steps taken on the construction site to control erosion and sediment.

A well designed ESC Plan includes appropriate locations of selected control measures, scheduling information for the installation of ESC practices, and details of the assigned responsibilities for implementation, operation, modification, inspection and maintenance.

The following principles will assist in creating an effective ESC Plan:

- Adopt a multi-barrier approach to provide erosion and sediment control through erosion controls first,
- Retain existing vegetation and stabilize exposed soils with vegetation where possible, erosion prevention is key in reducing sediment to downstream aquatic habitat;
- Limit the duration of soil exposure and phase construction when possible;
- Limit the size of disturbed areas by minimizing nonessential clearing and grading;
- Minimize slope length and gradient of disturbed areas;
- Maintain overland sheet flow and avoid concentrated flows;
- Store/stockpile soil away (e.g. greater than 15 metres) from watercourses, drainage features and top of steep slopes;
- Ensure contractors and all involved in ESC practices are trained in ESC Plan, implementation, inspections, maintenance, and repairs;
- Adjust ESC Plan at construction site to adapt to site features, and
- Assess all ESC practices before and after all rainfall and significant snowmelt events.

Specific details of current erosion and sediment control measures have been presented in **Appendix C**. The erosion and sediment control measures have been categorized as:

- Erosion prevention controls; and,
- Sediment controls including: perimeter controls, settling controls, and filtration controls.

Refer to **Appendix D**, Seed Mix Guidelines, April 2005 when working with vegetative erosion control measures.

## **6.1 Erosion and Sediment Control Plan Requirements**

An erosion and sediment control (ESC) plan can be submitted as a written report and/or separate drawing.

### **6.1.1 Erosion and Sediment Control Plan Requirements – Report**

An ESC Plan Report is required in addition to the ESC Plan drawing(s), in order to effectively summarize the base information, descriptions, and calculations upon which the ESC Plan was formulated. For example, a Stormwater Management Design Brief or similar type report typically includes documentation of the ESC requirements not listed or effectively illustrated on the ESC Plan drawings. **Table 2** below list the requirements for an ESC Plan Report.

**Table 2. Erosion and Sediment Control Requirements – Report.**

ESC Plan Requirements – Report	Check
<p><b>Project Descriptions:</b> Brief description of the nature and purpose of the land disturbing activity. Also include the legal description of the property and a reference to adjacent properties and landmarks.</p>	<input type="checkbox"/>
<p><b>Condition of Existing Site:</b> Description of the land use, site topography, vegetation, and drainage of the site under existing conditions.</p>	<input type="checkbox"/>
<p><b>Condition of Existing Receiving Water:</b> Description of local receiving waters such as watercourses and lakes (e.g. warm water fisheries, cold water fisheries; aquatic habitat use, confined or unconfined valley).</p>	<input type="checkbox"/>
<p><b>Adjacent Areas and Features:</b> Description of neighbouring areas, such as residential and commercial areas, reserves, natural areas, parks, storm sewers, and roads that might be affected by the land disturbance.</p>	<input type="checkbox"/>
<p><b>Soils:</b> A description of soils on the site, including erodibility, and grain size analysis. This description should include a summary of the soils/geotechnical report for the site.</p>	<input type="checkbox"/>
<p><b>Critical Areas:</b> Description of areas within the development site that have potential for serious erosion or sediment problems.</p>	<input type="checkbox"/>
<p><b>Permanent Stabilization:</b> Description of how the site will be stabilized after construction is completed. This will require a phasing plan (to be provided on the ESC Plan drawing) of the stripped area to be reseeded and the expected time of stabilization.</p>	<input type="checkbox"/>
<p><b>Design Details of Erosion and Sediment Control Measures:</b> The supporting calculations and design details of the sediment control measures. Specifically for ESC ponds - calculations and details include permanent pool and extended detention volumes, pond sizing volume, and calculations for the pond outlet and emergency overflow outlet.</p>	<input type="checkbox"/>
<p><b>Record Keeping Procedure:</b> Include sample inspection and maintenance forms. Maintenance Record keeping procedure including name/designate of the personal who will keep the inspection and maintenance record.</p>	<input type="checkbox"/>
<p><b>Stockpile Details:</b> Stockpile details to include the height and volume at each proposed location.</p>	<input type="checkbox"/>
<p><b>Emergency Contact:</b> Provide a list of emergency and non-emergency contacts (e.g. owner, site supervisor)</p>	<input type="checkbox"/>
<p><b>Stamped and Signed:</b> ESC document/report must be stamped and signed by a Professional Engineer.</p>	<input type="checkbox"/>

### **6.1.2 Erosion and Sediment Control Plan Requirements – Drawings.**

A complete application submission should provide the information and address the items identified in **Table 3** listed below. The information items that can be addressed on the drawings may be submitted provided that the overall format and content of the drawings are clearly presented for review. However, for effective presentation, a comprehensive ESC Plan often necessitates that the design rationale, calculations, and decisions upon which the ESC Plan drawing(s) are based, are summarized within a separate ESC Plan Report.

**Table 3. Erosion and Sediment Control Plan Requirements - Drawing(s)**

ESC Plan Requirements - Drawing(s)	Check
<p><b>General Items:</b></p> <ul style="list-style-type: none"> <li>• Site address including application number (e.g. SP or T number)</li> <li>• Key map including site boundary limits</li> <li>• A legend identifying ESC measures</li> <li>• Drawing scale</li> <li>• North arrow</li> <li>• Location of any existing or proposed building(s) or structure(s) on the site</li> </ul>	<input type="checkbox"/>
<p><b>Existing Contours:</b></p> <p>Existing elevation of the site at 0.5-1.0 m intervals to determine drainage patterns. Spot elevations may also be required. Extend existing contours to beyond property limit by a minimum of 30 meters.</p>	<input type="checkbox"/>
<p><b>Existing Vegetation:</b></p> <p>Location of any trees, shrubs, grasses, and unique vegetation to be preserved or removed. Tree hoarding area(s) to be clearly shown.</p>	<input type="checkbox"/>
<p><b>Water Resources Location(s):</b></p> <p>Location of any water body such as wetlands, lakes, rivers, streams, or drainage course on or adjacent to the site.</p>	<input type="checkbox"/>
<p><b>Regional Storm Flood Plain and Fill Regulated Areas:</b></p> <p>Regional flood line level, fill regulated line and reference to relevant hydraulic model cross-section where applicable.</p>	<input type="checkbox"/>
<p><b>Critical Areas:</b></p> <p>Area within or near the proposed development with potential for serious erosion or sediment problems.</p>	<input type="checkbox"/>
<p><b>Proposed Contours/Elevation:</b></p> <p>Proposed changes in existing elevation contours for each stage of grading. A cut/fill plan showing existing and proposed contours. Spot elevation for proposed conditions should also be illustrated.</p>	<input type="checkbox"/>
<p><b>Site Boundary Limits and Limits of Clearing and Grading:</b></p> <p>Site boundary limits and the limits of all proposed land disturbing activities.</p>	<input type="checkbox"/>
<p><b>Existing and Proposed Drainage Systems:</b></p> <p>Location and direction of any existing/proposed storm drainage system (e.g. storm sewers, swales, ditches, etc.) and overland flow drainage patterns within and adjacent to the site.</p>	<input type="checkbox"/>
<p><b>Limits of Clearing and Grading:</b></p> <p>A line defining the boundary of the area to be disturbed.</p>	<input type="checkbox"/>
<p><b>Stockpile and Berm Data:</b></p> <p>Stockpile and/or berm locations, size and the diversion route of the runoff. Consideration will include proximity to existing homes</p>	<input type="checkbox"/>
<p><b>Erosion and Sediment Control Measures Locations and Details:</b></p> <p>Location and details for all ESC measures proposed with notes provided to direct their timing/phasing such that there is an appropriate level of protection provided during all stages of construction (e.g. Sediment fence should be installed prior to any land disturbing activities).</p>	<input type="checkbox"/>



<p><b>Stormwater Management Systems:</b></p> <p>Plan and cross section profiles of ESC ponds/SWM ponds and location(s) to be shown.</p> <p>Also include the storm inlet, outlet, emergency outlet, and other permanent and temporary drainage facilities (swale, waterways, and channels). Volume, depth, and inflow and outflow rates should be provided. ESC pond maintenance target volumes and drainage areas to the pond to be specified.</p>	<input type="checkbox"/>
<p><b>Stormwater Discharge Locations:</b></p> <p>All stormwater discharge locations are to be identified and detailed.</p>	<input type="checkbox"/>
<p><b>Access Road:</b></p> <p>A description of the site's access and measures to be taken to prevent the transfer of sediment off site via construction vehicles</p>	<input type="checkbox"/>
<p><b>Internal Haul Road:</b></p> <p>The information about the internal haul road that will be used during construction and its maintenance schedule</p>	<input type="checkbox"/>
<p><b>Construction Phasing and Scheduling:</b></p> <p>Details of phasing of the construction project and the scheduling of the proposed construction works</p>	<input type="checkbox"/>
<p><b>Inspection and Maintenance:</b></p> <p>A schedule of regular inspections and repairs to erosion and sediment control practices that are provided in the ESC Plan. Monitoring and maintenance plan for sediment accumulation within the pond.</p>	<input type="checkbox"/>
<p><b>Stamped and Signed:</b></p> <p>All drawings must be stamped and signed as approved by a Professional Engineer.</p>	<input type="checkbox"/>

## 6.2 Developing a Worksite Isolation Plan for In-stream Construction

A work site isolation plan becomes a primary feature in an ESC Plan when an undertaking is proposed for an area that includes all or a portion of the wetted areas of watercourses, lakes or wetlands. In this case, the review of design alternatives and alternate construction methodologies should be investigated to minimize the potential for in-stream impacts. Examples of these would be jack and bore, directional drilling, tunneling, and pipe ramming. It is normal during this stage to also review the construction activities required, financial implications and the project schedule. Respecting the assessment stage of a project, the impact analysis of the undertaking has been completed with an understanding of the environmental conditions and a preferred construction methodology has been identified. This also allows for the development of layers of contingencies to further protect the environment from sediment and other disturbances. The plan is generally well understood during the approval process and specific conditions of this plan may be itemized in the permits and conditions.

All in-stream construction activities should adhere to MNR's Fisheries Construction Timing Guidelines based on watercourse species classifications (e.g. MNR, Maple District, Fisheries Management Plan, 1989-2000). More recent watershed based Fisheries Watershed Plans provide more recent information on construction timing windows. Please be advised that a mixture of both coldwater and warmwater species may be encountered in a watercourse. In this case, the construction timing will be a combination of the warmwater and coldwater construction timing window. The presence of redbreast dace in a watercourse will also follow the warmwater/coldwater

timing window combination. Local Conservation Authority or Ministry of Natural Resources staff should be consulted for site specific classifications and designated construction timing windows.

A general guideline for the Maple District in-stream construction windows is listed in **Table 4**, below. However, the local Conservation Authority should be contacted to confirm the timing guideline for other districts.

**Table 4. MNR’s Fisheries Construction Timing Guideline (MNR, 1989)**

<b>Creek Classification</b>	<b>Construction Permitted *</b>
WARMWATER CREEK (supports or contributes to warm water fisheries)	July 1 to March 31
COLDWATER CREEK (supports or contributes to coldwater fisheries)	June 15 to September 15
WARMWATER/COLDWATER SPECIES (both encountered in a watercourse and/or evidence of Redside Dace)	July 1 to September 15

**\*Contact the local CA to confirm the construction timing window for a specific watercourse. The Fisheries Management Plan for the Watershed and GIS thermal layers may be utilized to confirm these timing windows.**

In addition, monitoring requirements can be prescribed by the approvals to ensure that the activity is being supervised by appropriately trained and knowledgeable professionals both during and after completion of an undertaking.

Planning is critical during the days leading up to the execution of an isolation plan and the associated undertaking. The full duration of an in-water construction period may be needed to complete some large undertakings. Therefore it is ideal to allow the maximum permitted time available for this proposed construction. In other cases, weather conditions and water levels may drastically impact on the working days available within this construction period. The rule of thumb often quoted by risk managers is “the earlier and quicker the better”. In fact, a contract should be developed and funds allocated to complete these activities with that sentiment in mind to eliminate the exponential increases in project costs that can occur. All the required machinery, materials and person power should be on-site at the start of an in-water activity to avoid the risk of delays that could be encountered. A number of meetings are usually scheduled with the construction team as well as regulatory agencies to ensure that all parties know their roles and responsibilities. Long term and short term weather is observed routinely to provide the best prediction available to ensure the best conditions for construction.

Generally, the intent of the Worksite Isolation Plan is to isolate the construction activities and prevent impacts to receiving water bodies. The impact is generally the direct release of construction related sediment into a sensitive feature. This is one of the most significant aspects of any undertaking due largely to the heightened risk of construction in the water body. Essentially, the work area is isolated from the influence of surface water and/or groundwater or the water is removed through pumping. Removal of groundwater from an active construction area is done through dewatering.

Dewatering can draw groundwater levels down to elevations not impacted by construction through pumping wells and/or a connected well point system. A thorough understanding of the underlying soils and groundwater conditions is required to develop this type of design input. Particular care should be taken to limit the footprint of the construction in the adjacent areas from

any of these operations. Caution should be exhibited when dealing with adjacent landowners, land uses and environmental areas to ensure that the undertaking will not result in conflict (domestic water supply wells, watercourses, wetlands.). Surface water in streams and rivers can either be diverted or pumped around an active construction area or work can proceed after water containment is established.

Isolation can be accomplished through a number of measures itemized in **Appendix E** along with specifics regarding pumping and dewatering activities.

### **6.3    *Developing a Spill Control and Response Plan***

Spill control and a spill response system is a requirement of construction that is governed by legislation from both environmental and health and safety perspectives. This care and control should heighten “housekeeping” efforts to promote the control of these substances as well as to demonstrate compliance and due diligence. This scrutiny ensures that the machinery and equipment used during construction operations in sensitive environments be appropriately sized for the activity and also be well maintained. The materials and fluids required to operate and maintain the equipment as well as to complete the project must be controlled. The largest buffers possible between the feature and the re-fuelling or maintenance operation should be provided. Many different types of fluids and materials are required for construction and above the requirements stipulated in health and safety legislations, the constructor is required to have care and control of all of these fluids and materials that are deleterious to fish and fish habitat. The staging and stockpiling of materials should be scrutinized to ensure the minimum risk to the environment. Containment and use of these materials around environmental areas should comply with all applicable legislation. Spill prevention is the key to this plan requiring regular and preventative maintenance of all vehicles as well as proper containment and use of materials. Spill containment equipment and response plans provide added protection to a construction project. All required materials and equipment necessary for containment and clean up should be stored in an accessible location on site as well as in key vehicles. Minor spills should be immediately contained, cleaned up and removed from site. Significant mishaps should be reported immediately to the supervising engineer and environmental monitor who notifies the Spills Action Centre (**1-800-268-6060**) via the Contract Administrator. Details of the incident as well as updates on site conditions and containment/clean up efforts must be provided to the attending agency.

## 7.0 Inspections and Performance Monitoring

The environmental plans developed for an undertaking commonly provides a level of monitoring or supervision suitable for the sensitivity of the surrounding environment, the scale of a project and the expected time frames. Specific monitoring requirements are provided with the environmental approvals and permits, which are undertaken as a measure of compliance. The intention of this monitoring is to provide environmental protection, and compliance with all applicable legislation while contributing to the overall success of a project. This generally includes a number of inspections prior to the start of an undertaking to document the pre-disturbance conditions, and to ensure that the erosion and sediment control plan is initiated at the start of the project. Often, post construction monitoring is required to ensure the restoration, stabilization, and required monitoring of constructed features/habitats is established.

As a basis of monitoring an undertaking, it is essential to ensure that the erosion and sediment control measures are properly installed, well maintained and functioning as intended on a daily basis. The scrutiny placed on erosion and sediment control measures is applied by many parties involved in the project including environmental monitors, contractors, site inspectors and the Contract Administrator. The ESC plan should provide the framework for the inspection, maintenance including the need for repair, and record-keeping procedures during all stage of construction. The effectiveness of the ESC Plan depends directly on the frequency the ESC measures are inspected and what actions are taken to address any failures that may occur with the measures. A timely response by the contractor to any noted deficiencies is critical for demonstrating due diligence in compliance with regulatory requirements. As such, a regular inspection program should be planned and implemented to determine when ESC measures need maintenance and/or repair. Documentation of all inspections should be kept on site for a minimum of one (1) year after the development is substantially completed.

An Environmental Monitor (EM) can be retained by the project owner, the contractor or in some cases regulatory agencies and interested third parties. The role of the EM is to assure project construction activities comply with the environmental provisions defined in the project approvals, Authorizations and permits. It is important to note that an EM has no power to enforce compliance with any environmental laws. Environmental monitoring also offers a level of quality control and assurance not unlike other engineering inspectors retained for a project to ensure design standards are met. The EM is expected to provide timely and relevant advice in regards to the environmental management of a site, construction timing and methodologies. The EM should strive to remain neutral and independent in order to assess compliance of all project parties and allow for the accurate reporting of non-compliance events to the regulatory agencies.

An effective inspection program should include the following:

1. Identification of Personnel: Names and contact information of project members assigned to each task as well as agency/enforcement contacts. A communication protocol should also be developed to ensure effective reporting and compliance.
2. Details and locations of the environmental constraints for an undertaking including maps, reports, approvals and permits. Specific attention should be directed to timing restrictions and reporting requirements.
3. Construction drawings detailing the erosion and sediment controls installed which is updated through the construction period.

4. High risk areas should be identified on these drawings and routinely evaluated. Greater frequency of monitoring requirements may be required for areas and protection measures immediately adjacent to soil stockpiles, excavations, dewatering locations, protected features/areas, and locations where site runoff discharges into a receiving watercourse, water body, or municipal sewer system.
5. Inspection schedule: This should include inspection times, areas, and person(s) responsible for the inspections. A 'walk-through' inspection of the construction site should be undertaken in anticipation of large storm events (or a series of rainfall and/or snowmelt days) that could potentially yield significant runoff volumes. The regular inspections should occur during all construction stages and should be based on at a minimum the requirements identified in the permits and approvals. Commonly this frequency is:
  - on a weekly basis;
  - after every rainfall event;
  - after significant snowmelt events; and,
  - daily during extended rain or snowmelt periods.
6. During inactive construction periods, where the site is left alone for 30 days or longer, a monthly inspection should be conducted.
7. All damaged ESC measures should be repaired and/or replacement within 48 hours of the inspection.

A sample inspection and monitoring sheet is located in **Appendix F**.

## 8.0 References

California Department of Transportation (CALTRANS), 2002, CALTRANS Construction Sites Runoff Characterization Study, Sacramento, California.

Clarifica Inc., 2004, Assessment of Construction Sediment Control Ponds to Protect Receiving Waters, prepared for Toronto and Region Conservation and Fisheries and Oceans Canada, Toronto.

Department of Fisheries and Oceans (DFO), 2000, Effects of Sediment on Fish and their Habitat, DFO Pacific Region Habitat Status Report 2000/01.

Great Lakes Science Advisory Board (GLSAB), 1998, Non-point Sources of Pollution to the Great Lakes Basin, Toledo, Ohio.

Newcombe, C.P. and D.D. MacDonald, 1991, *Effects of suspended sediments on aquatic ecosystems*, North American Journal of Fish Management, 11:72-82.

Ontario Ministry of the Environment (OMOE), 1994, Stormwater Management Planning and Design Manual 2003, Ontario Ministry of the Environment, Toronto, Ontario.

Stormwater Assessment Monitoring and Performance (SWAMP) Program, 2005, Synthesis of Monitoring Studies Conducted Under the SWAMP Program, Toronto and Region Conservation Authority, Toronto.

TRCA and University of Guelph, 2006, Evaluation of Design Criteria for Construction Sediment Control Ponds – Markham, Ontario, TRCA, Toronto.

TRCA, 2006, Interim Watershed Characterization Report-TRCA Watersheds, Toronto.

Ward, N. 1992, The Problem of Sediment in Water for Fish, Northwestern Ontario Boreal Forest Management Technical Notes, Ontario Ministry of Natural Resources.

Waters, T.F., 1995, Sediment in Streams, biological effects and control, American Fisheries Society.

Transportation Association of Canada (TAC), May 2005, National Guide to Erosion and Sediment Control on Roadway Projects, Ottawa, Ontario.

---

# APPENDIX A

---

## EROSION POTENTIAL REFERENCE CHARTS





## Evaluation of Erosion Potential

Before selecting ESC practices, the erosion potential and sediment transport path must be evaluated. A methodical approach to assessing the potential for erosion and sedimentation from construction activities involves a number of screening evaluations. The following factors regarding the development site should be considered during the erosion potential evaluation:

- Soil Erodibility;
- Surface slope gradients;
- Length of slopes;
- Rainfall intensities; and,
- Runoff potential.

**Table A1** classifies erodibility for the various soil types. The texture and drainage of the soil are considered when estimating its erodibility.

**Table A1:** Hierarchy of Soil Erodibility

Soil Type	Erodibility Classification	Soil Erodibility Rating
Silt	Most	High
Silt Loam		High
Loam		High
Silty Sand		High
Sandy Loam		Medium
Silty Clay Loam		Medium
Sany Clay Loam		Medium
Silty Clay		Medium
Sandy Clay		Low
Clay		Low
Heavy Clay		Low
Loamy Sand		Low
Sand		Low
Poorly Graded Gravel		Least
Well Graded Gravel	Low	

Source: Adapted from Guidelines on Erosion and Sediment Control for Urban Construction Sites (MNR *et al.*,1987)

**Table A2** shows erosion potential based on soil erodibility, ground slope, and slope length. The surface gradients are generally grouped into three classes: gentle (0 to 10 %), moderate (10 to 15 %), and steep (> 15 %). Slope lengths are assessed as either moderate (under 30 m) or long (over 30 m).

**Table A2: Erosion Potential for Graded Slopes**

Slope Gradient	Soil Erodibility	Slope Length	
		< 30 m	> 30 m
< 2 % Gentle Slope	Low	Low	Moderate
	Medium	Moderate	Moderate
	High	Moderate	High
2 – 10 % Moderate Slope	Low	Low	Moderate
	Medium	Moderate	High
	High	High	High
> 10 % Steep Slope	Low	Low	Moderate
	Medium	High	High
	High	High	High

Source: Adapted from Guidelines on Erosion and Sediment Control for Urban Construction Sites (MNR *et al.*,1987)

**Table A3** shows erosion potential based on soil erodibility, channel slope, and slope length of channel.

**Table A3: Erosion Potential for Graded Conveyance Channels**

Channel Gradient	Soil Erodibility	Slope Length	
		< 30 m	> 30 m
< 2 % Gentle Slope	Low	Low	Moderate
	Medium	Moderate	Moderate
	High	Moderate	High
2 – 10 % Moderate Slope	Low	Low	Moderate
	Medium	Moderate	High
	High	High	High
> 10 % Steep Slope	Low	Low	Moderate
	Medium	High	High
	High	High	High

Source: Adapted from Guidelines on Erosion and Sediment Control for Urban Construction Sites (MNR *et al.*,1987)

Special attention must be given to critical areas within the proposed development that have the potential for serious erosion problems. For example, critical areas may include highly erodible soils, shorelines, human-made watercourses or ditches that outlet to a watercourse, and natural courses that may receive increased sediment-laden water.

---

## **APPENDIX B**

---

**REFERENCES FOR  
FEDERAL & PROVINCIAL REGULATIONS, MUNICIPAL BY-  
LAW(S) AND CONSERVATION AUTHORITIES ACT**

**REFERENCES FOR ADDITIONAL INFORMATION**



## **FEDERAL REGULATIONS**

Environmental Protection Act

Provincial - <http://www.e-laws.gov.on.ca:81/ISYSquery/IRL8C89.tmp/66/doc> or

Federal - <http://laws.justice.gc.ca/en/C-15.31/text.html>

Federal Fisheries Act

<http://laws.justice.gc.ca/en/F-14/240479.html> or

<http://laws.justice.gc.ca/en/F-14/text.html>

Navigable Waters Protection Act

<http://laws.justice.gc.ca/en/N-22/251715.html> or

<http://laws.justice.gc.ca/en/N-22/text.html>

Canadian Environmental Assessment Act

<http://laws.justice.gc.ca/en/C-15.2/275414.html> or

<http://laws.justice.gc.ca/en/c-15.2/text.html>

Migratory Birds Convention Act

<http://laws.justice.gc.ca/en/M-7.01/250946.html> or

<http://laws.justice.gc.ca/en/M-7.01/text.html>

Species at Risk Act

<http://laws.justice.gc.ca/en/S-15.3/276773.html> or

<http://laws.justice.gc.ca/en/s-15.3/text.html>

Canadian Wildlife Act

<http://laws.justice.gc.ca/en/W-9/265232.html> or

<http://laws.justice.gc.ca/en/W-9/text.html>

Endangered Species Act

<http://www.gnb.ca/0062/acts/acts/e-09-101.htm>

## **PROVINCIAL REGULATIONS**

Ontario Water Resources Act (OWRA)

[http://www.e-laws.gov.on.ca/DBLaws/Statutes/English/90o40\\_e.htm](http://www.e-laws.gov.on.ca/DBLaws/Statutes/English/90o40_e.htm)

Lakes and Rivers Improvement Act

[http://www.e-laws.gov.on.ca/DBLaws/Statutes/English/90i03\\_e.htm](http://www.e-laws.gov.on.ca/DBLaws/Statutes/English/90i03_e.htm)

Provincial Policy Statements and Planning Act

[http://www.mah.gov.on.ca/userfiles/page\\_attachments/Library/1/789108\\_ppsenglish.pdf](http://www.mah.gov.on.ca/userfiles/page_attachments/Library/1/789108_ppsenglish.pdf)

For more copies of Provincial legislations in either English or French please contact:

**Publications Ontario Bookstore**

880 Bay Street

Toronto, Ontario

M7A 1N8

1-416-326-5300 or

1-800-668-9938

TTY number (teletypewriter): 1-800-268-7095 or 416-325-3408

Or on-line: <http://www.gov.on.ca/MBS/english/publications/>

Oak Ridges Moraine Conservation Plan

<http://www.e-laws.gov.on.ca:81/ISYSquery/IRL8E2A.tmp/7/doc>

Permit to Take Water

<http://www.e-laws.gov.on.ca:81/ISYSquery/IRL8E47.tmp/2/doc>

Source Water Protection Act

[http://www.ene.gov.on.ca/envision/env\\_reg/er/documents/2004/aa04e0002.pdf](http://www.ene.gov.on.ca/envision/env_reg/er/documents/2004/aa04e0002.pdf) or

<http://cela.ca/uploads/f8e04c51a8e04041f6f7faa046b03a7c/479dwspa2004.pdf>

## **MUNICIPAL BY-LAW(S) AND CONSERVATION AUTHORITIES ACT**

Conservation Authorities Act

[http://www.e-laws.gov.on.ca/DBLaws/Statutes/English/90c27\\_e.htm](http://www.e-laws.gov.on.ca/DBLaws/Statutes/English/90c27_e.htm)

Development, Interference with Wetlands and Alterations to Shorelines and Watercourses  
Regulation

<http://www.svca.on.ca/ro6169.htm>

Section 142 of the Ontario Municipal Act, 2001

[http://www.e-laws.gov.on.ca/DBLaws/Statutes/English/01m25\\_e.htm#BK164](http://www.e-laws.gov.on.ca/DBLaws/Statutes/English/01m25_e.htm#BK164)

The municipality should be contacted for by-laws they may have regarding, but not limited to: erosion and sediment control; top-soil removal; tree removal; and, site alteration and servicing agreement.

*The website links listed above are valid as of December 2006 and may be updated in the future.*

## **REFERENCES FOR ADDITIONAL INFORMATION:**

Transportation Association of Canada (TAC), 2005, **National Guide to Erosion and Sediment Control on Roadway Projects.**

Ontario Ministry of Transportation, Ontario Ministry of Natural Resources, 2003. **A Fisheries Protocol: agreement between the Ontario Ministry of Transportation and Ontario Ministry of Natural Resources for protecting fisheries resources on provincial highway undertakings.**

Ontario Ministry of Transportation – Research and Development Branch and Armstrong, Jack. J., 1992. **Protocol for the testing of surficial erosion control materials.**

Ontario Ministry of Transportation, Ontario Ministry of Natural Resources, Canadian Department of Fisheries and Oceans, 2006. **Protocol for protecting fish and fish habitat on Provincial transportation undertakings.**

Ontario Ministry of Transportation – Research and Development Branch and Armstrong, Jack. J., 1993. **The effective use of surficial erosion control materials in the planning and design of highways.**

Merritt, Bill, Ontario Ministry of Transportation, Ontario Ministry of the Environment and Ontario Ministry of Natural Resources, 1997. **Erosion and sediment control workshop for MTO highway projects.**

Chilibeck, B.G. Chislett and G. Norris. **Land Development Guidelines for the protection of Aquatic Habitat.** Province of British Columbia Ministry of Environment, Lands and Parks, 1993.

Ontario Ministry of Transportation, Armstrong, Jack J. Wall, G.F., 1990. **Quantitative evaluation of the effectiveness of erosion control materials.**

**Environmental monitoring for construction projects.** Nanaimo, BC. Malaspina University-College, 2005.

Department of Fisheries and Oceans, Ontario Ministry of Natural Resources, 2000. **Extension Notes: Protecting fish habitat from sediment.**

Sutherland. Ross. A. Ziegler. Alan D. **Hillslope runoff and erosion as affected by rolled erosion control systems: a field study.** University of Hawaii, 2006.

Consumer Gas Company Limited, 1994. **Environmental management manual for environmental protection during pipeline construction.**

Ontario Ministry of Natural Resources, 1994. **Environmental management manual for environmental protection during pipeline construction.**

Ministry of Transportation, 2006. **Environmental guide for fish and fish habitat.**

Ministry of Transportation, 2002. **Environmental reference for highway design.**

Ministry of Transportation, 2004. **Construction administration and inspection task manual.**





---

## **APPENDIX C**

---

**EROSION CONTROL PRACTICES  
SEDIMENT CONTROL PRACTICES**



## **EROSION CONTROL PRACTICES**

Erosion prevention is essential and is the most effective method in protecting downstream aquatic habitat during the construction process. Erosion controls involve minimizing the extent of disturbed areas by clearing only what needs to be cleared, preserving and protecting natural cover and immediately stabilizing disturbed areas. **Table C1** lists some commonly used erosion prevention controls, but should not be limited to this list.

**Table C1. Erosion Control Measures.**

Name of Erosion Control Measure	Applicability						Temporary	Permanent	Reference Page
	Slopes	Streams/Rivers	Surface Drainage Ways	Table Lands	Borrow/Stockpile	Adjacent Property			
Vegetative Filter Strips	√	√	√	√	√	√	√		C-2
Mechanical Seeding*	√		√	√	√	√	√	√	C-3
Terraseeding*	√		√	√	√	√	√	√	C-5
Hydroseeding*	√		√	√	√	√	√	√	C-7
Top soiling	√		√	√	√	√		√	
Sodding	√		√	√	√	√		√	
Mulching	√		√	√	√	√	√	√	
Re-vegetative Systems	√		√	√	√	√	√	√	
Tree and Shrub Planting	√	√	√	√	√	√		√	
Erosion Control Matting/Blanket/Net (with Seed)	√		√	√	√	√		√	C-8
Growth Media Erosion Control Blanket	√	√	√	√	√	√	√	√	C-11
Lockdown Netting	√		√	√			√	√	C-14
Buffer/Riparian Zone Preservation		√						√	
Surface Roughening (Scarification)	√				√		√		C-16
Edge Saver	√	√		√				√	C-18

Note: \* Various seeding practices.

## **VEGETATIVE FILTER STRIPS (VFS)**

### *DEFINITION & PURPOSE*

Most sites contain some type of existing natural vegetation or a planted area particularly on slopes and adjacent to drainage courses. Making use of existing vegetation to filter out sediment is an effective, low cost measure for protecting the ground surface from erosion, enforcing sediment control, and improving the infiltration capacity of the soil. Thick and matted existing grass and vegetation is the most effective type of vegetative filter.

### *APPLICATION*

Vegetative filter strips are located immediately adjacent to a watercourse and act as living sediment filters that intercept and detain stormwater runoff from up-gradient disturbed areas. They reduce the flow and velocity of surface runoff, promote infiltration, and reduce pollutant discharge by capturing and holding sediments and other pollutants carried in the runoff water. Filter strips are fairly level and treat sheet flow across them.

### *DESIGN CONSIDERATIONS*

- Vegetative filter strips should be maintained 30 metres wide adjacent to cold water creeks (capable of sustaining trout) and 15 metres wide adjacent to warm water creeks (capable of sustaining other fish species). MNR should be contacted for the particular creek classification.
- Additional ESC measure such as sediment control practices should be installed up-gradient to help prevent overloading of the filter strip and prevent construction vehicles from entering the area
- Limit of work devices must extend to the edge of the tree “drip line” in order to protect tree roots from damage due to tracked vehicles and soil compaction.

### *INSTALLATION & MAINTENANCE CONSIDERATIONS*

- Construction vehicles are not permitted to travel over existing vegetation or planted vegetation, which act as a vegetative filter strips.
- Stored equipment and materials, soil stockpiles, and vehicles must be kept away from preserved trees to prevent soil compaction and/or vehicle tracking. Root damage will result in the slow death of the tree.
- Explain to all construction equipment operators the importance of remaining outside of the fenced vegetated filter strip.
- Not effective for filtering high velocity flows from paved areas, steep slopes or hilly areas.
- Inspect and maintain vegetative filter strips on a weekly basis.

## MECHANICAL SEEDING

### *DEFINITION & PURPOSE*

The establishment of vegetative cover achieved by seeding disturbed areas with the use of machinery. An effective, long term, relatively inexpensive measure. Vegetative cover is one of the most effective methods of stabilizing exposed soil and reducing erosion due to rainfall and runoff.

### *APPLICATION*

Should be applied to any disturbed surface that is to be left exposed for 30 days or greater and for areas that are at final grade. Seeding can be applied to stabilize floodplain and valley bank surfaces, and stormwater pond embankments.

### *DESIGN CONSIDERATIONS*

- Manufacturer must be consulted to confirm appropriate method of seeding and seed species to ensure successful germination and provide an effective measure.
- Local Conservation Authority must be contacted for approval of seeding method and seeding species utilized.
- Effective on shallow slopes typically 3H:1V or flatter.
- Seed mix design and application rate will depend on the season, soil type and if cover is permanent or temporary.
- Methods include Broadcast seeder or Drill seeder.
- Native vegetation species should be utilized wherever possible. Refer to the April 2005 Seed Mix Guideline (Appendix D) for preferred vegetative species. Contact local Conservation Authority for a most current vegetative list.
- For interim erosion control measures, the proponent must ensure no sediment is entrained off the area and must provide at minimum temporary seeding of native or non-invasive species whether perennial or annual.
- Optimal seeding time for all seeding – April 15 to May 30 and August 15 to September 30. If seeding occurs after September 30, additional erosion and sediment control measures may be required to minimize sediment transport off-site, and seeding may be required the following growing season.
- Caution should be used when seeding during drought conditions. Subsequent applications of mechanical seeding may be required for successful vegetation establishment and soil stabilization.
- Optimal seeding time for dormant wildflower seed is in the autumn. However, seeding may also occur in late spring, during drier conditions.
- Mulch application following or in conjunction with seed application is highly recommended as the mulch serves as a barrier against solar heat, moisture loss and physical transport due to runoff.
- A minimum 150 mm of top soil should be applied to all areas subject to permanent landscaping. ***The top-soil may need to be stabilized with and erosion control process after seeding application has been completed.***

### *INSTALLATION & MAINTENANCE CONSIDERATION*

- Seedbed surface should be rough, firm but not too loose or too compacted.
- Seed can be spread by hand for small areas and topsoil stockpiles. Mechanical methods are recommended for larger areas to ensure proper application rate.
- Localized areas which may have a “poor” catch of seed will require re-seeding or alternative measures.
- Some sites, particularly large ones, may have to be cleared and seeded several times during the project construction period.

## **TERRASEEDING™**

### *DEFINITION & PURPOSE*

Terraseeding™ is the computer calibrated injection of seed into a non-slurried mulch, compost, fibre, or growth media during the application process by an Express Blower™ truck. This measure protects the soil surface from direct rainfall impact, reduces the velocity of overland runoff, and fosters the growth of vegetation by conserving moisture and preventing the washing away of seed.

### *APPLICATION*

Applied for the stabilization of exposed soil surfaces and the rapid establishment of both temporary and permanent vegetation. Terraseeding provides the establishment of vegetation quicker than hydroseeding.

### *DESIGN CONSIDERATIONS*

- Manufacturer must be consulted to confirm appropriate method of seeding and seed species to ensure successful germination and provide an effective measure.
- Local Conservation Authority must be contacted for approval of seeding method and seeding species utilized.
- Terraseeding is quite effective and can be used to protect seedbeds on difficult slopes (i.e. greater than 3:1) and/or where access is limited.
- Depth of non-slurried mulch, compost, fibre or growth media changes for different applications (i.e. topdressing on a 5:1 slope – 12.5mm depth to erosion control on a 1:1 slope – 100mm depth)
- Growth Media is derived from composted materials and shall be weed free and derived from a well-decomposed source of organic matter. The growth media shall be produced using an aerobic composting process meeting or exceeding, M.O.E. 101, C.C.M.E. Type “A” and Type “AA” regulations, and Compost Quality Alliance Program (C.Q.A.) including time and temperature data indicating effective weed seed, pathogen and insect larvae kill. The growth media shall be free of any refuse, contaminants or other materials toxic to plant growth. Non-composted products will not be accepted. Test methods for the items below should follow USCC TMECC guidelines for laboratory procedures:
  - PH – 5.0-8.0 in accordance with TMECC 04.11-A, “Electrometric pH Determinations for Compost”
- For seeded Growth media, seed should be incorporated at the time of application in the entire depth of the growth media blanket, at rates per unit area as acceptable to the engineer. The following particle sizes shall also be followed: 100% passing a 50mm sieve, 99% passing a 25mm sieve, minimum of 60% passing a 12.5mm sieve. All other testing parameters remain the same
- The effectiveness of some terraseeding is limited by the season; therefore follow specific manufacturer's specifications.

### *INSTALLATION & MAINTENANCE CONSIDERATIONS*

- Terraseeding application must follow manufacturer's specification.

- Inspect periodically, especially after rainfall for any damage to the mulch and repair or reapply terraseed as soon as possible.



## HYDROSEEDING

### *DEFINITION & PURPOSE*

Hydroseeding is a process of mixing seed, fertilizer, paper mulch with dye and water inside a tank, then spraying the mixture onto exposed surfaces. It is not an erosion control method unless a bonded fibre matrix is applied with the material or a straw, wood fibre, coconut fibre mat or equivalent, blanket is applied ovetop and secured into place by staples. These measures protect the soil surface from direct rainfall impact, reduce the velocity of overland runoff, and foster the growth of vegetation by conserving moisture and preventing the washing away of seed.

### *APPLICATION*

Applied on-top of freshly prepared, cultivated soil. Application for the stabilization of exposed soil surfaces and the rapid establishment of both temporary and permanent vegetation.

### *DESIGN CONSIDERATIONS*

- Manufacturer must be consulted to confirm appropriate method of seeding and seed species to ensure successful germination and provide an effective measure.
- Local Conservation Authority must be contacted for approval of seeding method and seeding species utilized.
- The effectiveness of some hydroseed is also limited by the season; therefore follow specific manufacturer's specifications.
- Hydroseed is quite effective and can be used to protect seedbeds on difficult slopes (i.e. greater than 3:1) and/or where access is limited.
- Straw mulch is most desirable, but it must be anchored/crimped to avoid becoming wind blown.

### *INSTALLATION & MAINTENANCE CONSIDERATIONS*

- Hydroseed application must follow manufacturer's specification (e.g. rate, depth of cover).
- Straw mulch should be applied to a depth of 25 mm to 50 mm at a rate of 4 tonnes/ha.
- Loose straw mulch can be crimped or indented into the ground 35 mm to 60 mm by using a steel tracked vehicle with deep cleats or by using dull, vertically set agricultural disks.
- Inspect periodically, especially after rainfall for any damage to the mulch and repair or reapply mulch as soon as possible.

### *NOTES*

- Thickness of mulch application may need to be increased for disturbed areas in or near sensitive water resources or other areas highly susceptible to erosion.



## **EROSION CONTROL BLANKETS, MATS, NETS**

### *DEFINITION & PURPOSE*

Erosion control blankets, mats or nets, are prefabricated layers of material, generally biodegradable, which are laid on a soil surface to prevent erosion and promote seed growth. Nets consist of degradable material tightly woven into a photodegradable mesh. Blankets are simply fibres woven within a photodegradable netting to form a thick fibre blanket. Mats may consist of hardy materials such as coconut husk fibres, wood shavings or synthetic fibres that form a stronger/heavier material layer or “mat”.

### *APPLICATION*

Erosion control blankets, mats or nets should be applied to un-vegetated conveyance systems including swales and ditches as these systems receive concentrated flows. They should also be applied to all exposed slopes with greater than 2H:1V and are subject to rainfall and runoff. Erosion control blankets, nets and mats may be applied within a watercourse, however, the local Conservation Authority must be contacted for approval of these measures.

### *DESIGN CONSIDERATIONS*

The many different site conditions will dictate whether a net, blanket or mat is required. For example, a temporary diversion swale required for watercourse realignment would require a mat due the long duration for the temporary swale to be in place (6 to 12 months) and the potential for higher flows. It is recommended that the manufacturer and the local CA be consulted prior to installation.

### *NETS*

- Woven structure forms a high-tensile strength net.
- Highly erodible slopes may require application of a sub layer of straw mulch overlain with netting, which is stapled through to enhance ground contact.
- Typically composed of jute, straw or Coir (coconut fibres) material.

### *BLANKETS*

- Simply woven structure reduces tensile strength, but enhances contact with the ground.
- Typically composed of Coir, straw or wood fibre material.

### *MATS*

- Material strength provides turf reinforcement, and reduces the energy of run-off to provide lasting erosion protection.
- Matting can be placed directly on seeded slope or with a sub-layer of mulch to enhance ground contact.
- Typically composed of 100% coconut husk fibres or synthetic polypropylene fibres.

### *ALL*

- Retains moisture from precipitation thereby significantly reducing runoff from bare slopes and in turn promoting the early germination of seeds.
- Straw and/or combination straw and Coir blankets should be applied to steep slopes.

- Synthetic materials used in netting typically deteriorate in three to four months but some types may not biodegrade as quickly and manufacturers should be consulted regarding the specific application.
- Follow specific manufacturer's specifications regarding maximum allowable slopes and flow velocities.

### *INSTALLATION & MAINTENANCE CONSIDERATIONS*

To be installed on a seeded slope (with or without mulch).

- A firm, continuous contact between the blanket and soil is critical. Careful rolling after installation and stapling may be required to obtain firm contact.
- Care must be taken during installation to remove all foreign debris (i.e. rocks, branches, plastics) to prevent blanket, mats or nets from tenting due to lack of firm contact with the soil surface. Tenting creates a drip zone which causes erosion under the blanket (i.e. distance between blanket and soil surface).
- Specific manufacturer's instructions must be followed (re: blanket type/application, anchoring, and staple pattern).
- Orientation of the nets/blankets/mats within the :
  - ⇒ **Conveyance System Side Slopes** - Orient nets/blankets/mats vertically down the slope (i.e. with the direction of runoff).
  - ⇒ **Channels** - Orient nets/blankets/mats with the direction of flow. Erosion control blankets, nets, and mats may be applied within the channel of a watercourse; however, the governing Conservation Authority will need to be contacted for approval.
- Blankets should overlap at edges and at end – Refer to manufacturer's instructions for the exact details of installation.
- Metal staples or wooden stakes are used to anchor nets/blankets/mats to the ground. Refer to manufacturer's instructions for the exact details of staple/stake spacing.
- Top and bottom ends may need to be secured in an anchor trench.
- Inspect periodically until vegetative cover is established, particularly after each rainfall event for any damage to the blanket. Repair all damaged areas immediately.

Figures illustrating the installation of erosion control mats, blankets, and nets from Keeping Soil on Construction Sites (HRCA & HCA, 1994).

**Shallow Slope**  
Strips may be applied across the slope

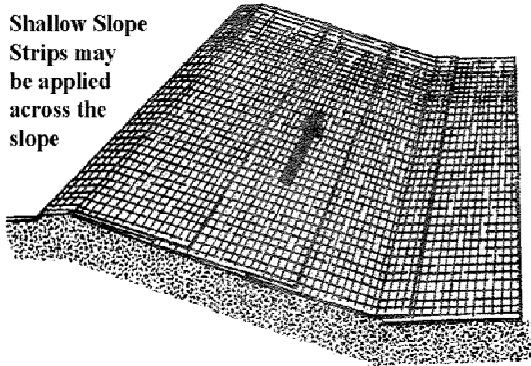

**Ditch/Channel**  
Strips applied parallel to direction of flow

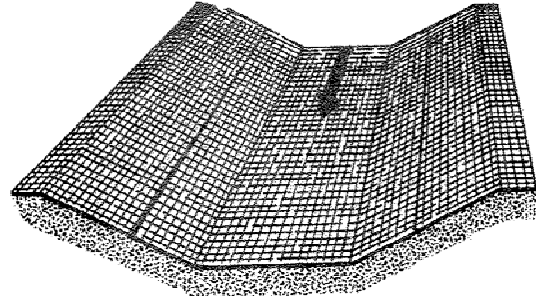

**Steep Slope**  
Strips applied down the slope

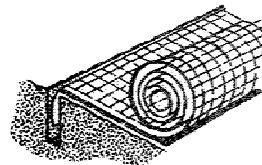
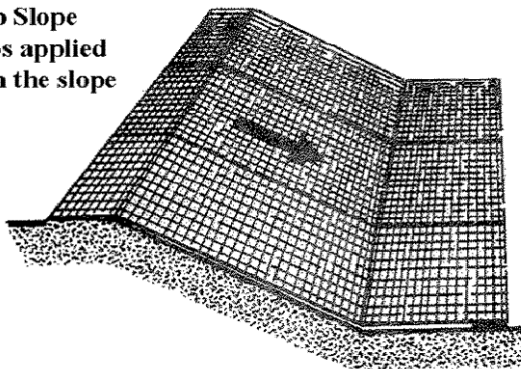

Anchor top/high end of roll in a 150 mm deep trench

Staple across net at 300 mm intervals

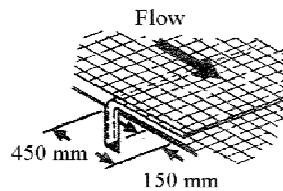

Overlap ends by 450 mm

Staple across area of overlap at regular intervals (300 mm)

Material	Rate Per Acre	Notes
Straw	1 – 2 tons	From wheat or oats; spread by hand or machine; should be tacked down.
Wood Fiber	0.1 – 1 ton	May be hydroseeded; Do not use in hot weather.
Bark	35 cubic yards	Apply with mulch blower, chip handler, or by hand; do not use asphalt tack.
Jute Net	Cover Area	Withstands water flow; best if used with organic mulch.
Fiberglass Net	Cover Area	Withstands water flow; best if used with organic mulch.
Wood Fiber Net	Cover Area	Withstands water flow.

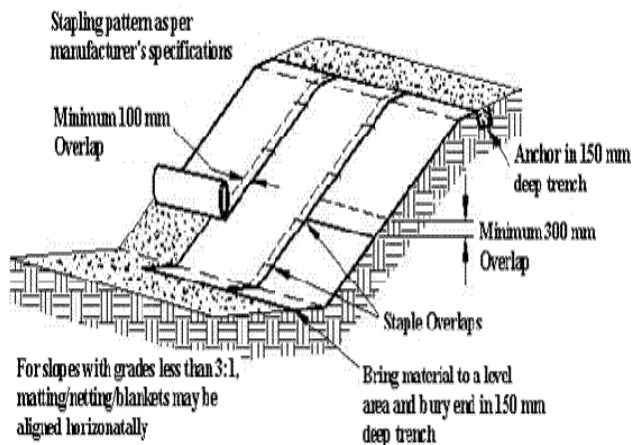

## **GROWTH MEDIA EROSION CONTROL BLANKETS**

### *DEFINITION & PURPOSE*

Growth media erosion control blankets are applications of growth media derived from composted materials applied with a pneumatic blower device or equivalent that help to reduce or prevent erosion on slopes in a living or non-living form. Growth media erosion control blankets prevent erosion by covering the exposed soil surfaces and keeping the water flowing on/within the materials. Growth media erosion control blankets also help increase infiltration and retention of rainwater, which aids in vegetation establishment and storm water management.

### *APPLICATION*

Growth media erosion control blankets are to be used on exposed soil areas either for temporary or long-term protection against erosion. Growth media erosion control blankets may be used in place of other traditional blanket technology (e.g. geotextiles) with similar or superior results. Growth media erosion control blankets are especially effective on extreme slopes of 3:1 to 1:1 or greater and for situations where many other erosion control tools do not work. Growth media used in the blanket also has the ability to bind various contaminants contained in runoff.

### *DESIGN CONSIDERATIONS*

- For most applications, it is important to apply Growth media erosion control blankets at about a 25mm-100mm depth; however, this may vary depending on slope and size of the drainage area. Growth media meeting or exceeding the specification attached is predictably successful at reducing or eliminating erosion.
- Growth media erosion control blankets are normally installed using a pneumatic blower device or 'blower truck'. This equipment must be used to comply with this specification and the vehicles must have a calibrated seeder attachment for 'living blanket' applications that require seeding. Alternate seeding mechanisms may be used, including blending seed into the growth media evenly prior to application with the blower trucks.
- There are no major limitations to the use of Growth media erosion control blankets, if installed properly. However, when slopes exceed 2:1, care should be taken to make sure the depth of the blanket is at least 50mm. If slopes approach 1:1, an additional 25mm to 50mm should be added to make the blankets a total of 75mm to 100mm depth. The Engineer may also require additional LockDown™ netting be placed over the blankets and stapled into the soil for further protection against sheer strength of underlying soil or movement of Growth media during severe storm events.
- It is imperative at all times that Growth media erosion control blankets are 'lapped' over the top of the shoulder of the slope they are applied to. A minimum overlap of 1m to 3m is suggested in order to make sure water runs on top of the Growth media blanket, not under it. If the Growth media erosion control blankets are not installed properly and water is allowed to get under the Growth media blanket at the top of the slope, rills may form and the slopes will have to be repaired.
- Growth Media is derived from composted materials and shall be weed free and derived from a well-decomposed source of organic matter. The growth media shall be produced using an aerobic composting process meeting or exceeding, M.O.E. 101, C.C.M.E.





Type “A” and Type “AA” regulations, and Compost Quality Alliance Program (C.Q.A.) including time and temperature data indicating effective weed seed, pathogen and insect larvae kill. The growth media shall be free of any refuse, contaminants or other materials toxic to plant growth. Non-composted products will not be accepted. Test methods for the items below should follow USCC TMECC guidelines for laboratory procedures:

- PH – 5.0-8.0 in accordance with TMECC 04.11-A, “Electrometric pH Determinations for Compost”
- Non seeded Growth media erosion control blankets: Particle size – 100% passing a 50mm sieve, 99% passing a 25mm sieve, minimum of 90% passing a 18.25mm sieve in accordance with TMECC 02.02-B, “Sample Sieving for Aggregate Size Classification”.
- For seeded Growth media erosion control blankets, seed should be incorporated at the time of application in the entire depth of the Growth media blanket, at rates per unit area as acceptable to the engineer. The following particle sizes shall also be followed: 100% passing a 50mm sieve, 99% passing a 25mm sieve, minimum of 60% passing a 12.5mm sieve. All other testing parameters remain the same.
- Moisture content of less than 60% in accordance with standardized test methods for moisture determination.
- Material shall be relatively free (<1% by dry weight) of inert or foreign man made materials.
- A sample shall be submitted to the engineer for approval prior to being used and must be a certified Filtrexx growing media which also complies with all local, provincial and federal regulations.
- Installer is required to be a certified as determined by Filtrexx Canada Inc. Certification shall be considered current if appropriate identification is shown during time of bid or at time of application.

#### *INSTALLATION AND MAINTENANCE CONSIDERATION*

- Description: This work shall consist of furnishing, installing, maintaining and seeding a water permeable Growth media erosion control blanket to reduce soil erosion and sediment by preventing soil particles from water moving off site into adjacent waterways or storm water drainage systems.
- Growth media erosion control blankets should be inspected weekly and after all rainfall and/or snowmelt events to make sure they hold and are protecting the soil adequately. In cases where minor rills form, they should be repaired immediately by blowing more product onto the slopes and into the rills and compacting the area with foot traffic and a Siltsoxx™ or berm may be required to slow water down to sheet flow.
- Growth media erosion control blankets will be placed at locations indicated on plans as directed by the Engineer. Unless otherwise specified, Growth media erosion control blankets should be installed at a minimum depth of 25mm. Consult with the manufacturer for the depth requirements. Depth requirements are also listed in Figure below.
- Growth media erosion control blankets may be seeded at time of installation for establishment of permanent vegetation. The Engineer will specify seed requirements.

- Growth media erosion control blankets are not to be used in direct flow situations or in runoff channels.
- See attached schematic for Growth Media Erosion Control Blanket Installation.
- If required, combining Growth media erosion control blankets with SiltSoxx™ or Filter Berms may offer additional protection from slopes that have heavy run-on water. In these situations, SiltSoxx™, Filter Berms and Growth media erosion control blankets may be used in combination.

SLOPE	A	B
	4" (100mm)	3" (75mm)
	3" (75mm)	2" (50mm)
	2" (50mm)	
	1" (25mm)	

OPTION A - FILTREXX™ COMPOST BLANKET - SEE SPEC.  
 OPTION B - FILTREXX™ COMPOST BLANKET WITH LOCK DOWN NETTING - SEE SPEC.

<b>FILTREXX™ CANADA</b>			
<small>324 GOVENORS RD. EAST PARIS, ONTARIO CANADA N3S 3E1 519-754-8296</small>			
<b>FILTREXX™ INTERNATIONAL</b>			
<small>35481 GRAFTON EASTERN RD GRAFTON, OH USA 44044 440-926-8041</small>			
COMPOSITE BLANKET TABLE			
DESIGN:	R.D.B.	SCALE:	NTS
CHECKED:	R.D.B.	DRAWN:	G.W.S.
SHEET:	7 of 7	DRG. No:	
DATE:			T7

- The installer shall maintain the Growth media erosion Control Blanket in a functional condition at all times and it shall be inspected weekly and after all rainfall and/or snowmelt events.
- The Growth media erosion Control Blanket will be seeded on site, at rates and seed types as determined by the Engineer or the Conservation Authority.
- Installer shall provide the Engineer with proof that (e.g. a 50mm) Growth media erosion Control Blanket has been applied. This rate equals approximately 510 cubic meters per hectare. Contractor will supply ample evidence showing this amount of material has been effectively placed (e.g. truck load tickets, depth to be measured at time of application by site inspector).

## **LOCKDOWN™ NETTING**

### *DEFINITION & PURPOSE*

For slopes that are greater than a 3:1 with loose, highly erodable soil. Soils that are sandy or low in organic matter are particularly prone to erosion and would be excellent candidates for this product.

Where concerns for slope stability is high and where shear strength is a concern. The Lockdown™ Netting allows the roots to help hold the slope and keeps the turf from sliding off the slope, once vegetated.

### *APPLICATIONS*

For areas where long term reinforcement is required due to high flow rates or where extra shear strength is needed to retain the vegetation on steep slopes.

### *DESIGN CONSIDERATIONS*

Material used may be either cotton or HDPE netting materials. For more permanent applications, use of the HDPE is recommended. For stabilization that is not required beyond the vegetation establishment phase, the cotton product is recommended.

#### *Cotton material and netting specs:*

- The 2.4m cotton LockDown Netting™ is made up of 143 chain stitches of 20/2 cotton yarn across the width of the fabric.
- Approximately 14mm wide by 25mm long holes.
- The fabric is reinforced at both edges. Each edge consists of 5 interlocking chain stitches made with 20/2 cotton to form an 18.75mm wide edge.
- The roll is 1000 meters long and 2.4m wide.
- The roll weighs approximately 50kg.

#### *HDPE material and netting specs:*

Material: HDPE Plastic  
9.2 m wide lay flat netting  
5 mil PLASTIC – with Kelly Green UV colorant

Thermal Properties: Melts at approximately 97 °C

UV Life: UV inhibitor is added to the colorant to extend the life of the product in direct exposure to sunlight. The UV level provides a 3-5 year life, however actual testing has not been performed.

Mesh Pattern: HEXAGON ~ 25mm mesh opening

Stretch Width: 9.2m

Roll Length: 114.3m

### *INSTALLATION & MAINTENANCE*

- This work shall consist of furnishing, installing, & maintaining LockDown™ Netting prior to installation of a Growth media Erosion Control Blanket.



- ***LockDown™ Netting shall be installed to cover the slope completely. Staking must be done prior to Growth media applications and a minimum of 3 stakes (sod staple or equivalent) per 0.91 square metre must be used.***
- If using the cotton material, roll out the netting on the slope and stretch until taut. Lay the cotton material on top of the soil and stake accordingly.
- If using the green HDPE material, unfold the netting and stretch to 9.14m. Stretch material across slope until taught, then stake accordingly.
- For extreme slopes that require installers to use repelling gear, care should be taken to tie off HDPE netting at the top of the slope to a firmly anchored item in the landscape, such as a tree or permanent stake. This ensures the staking system is not the only anchoring device used on such a steep slope.
- The installer shall maintain the system and repair it if it fails for the period of vegetation establishment.
- Vegetation established on top of LockDown™ Netting shall be rated at over 70% establishment/coverage in order for the project to be considered ‘fully vegetated and protected’.
- Installer is responsible for establishing a working erosion control system and may, with approval of the Engineer, work outside the minimum construction requirements as needed.
- Installer is required to be certified as determined by Filtrexx Canada Inc. Certification shall be considered current if appropriate identification is shown during time of bid or at time of application.
- Lockdown™ Netting shall be installed on site as detailed above.



## **SURFACE ROUGHENING (SCARIFICATION)**

### *DEFINITION & PURPOSE*

This measure is also referred to as scarification and provides for a rough soil surface with the horizontal depressions created by operating suitable equipment on the contour, or by leaving slopes in a roughened condition without fine grading. This measure aids in seed bed preparation and establishment of vegetative cover, reduces runoff velocity and quantity, increases infiltration and provides some sediment trapping.

### *APPLICATION*

Can be applied to any disturbed surface that is to be left temporarily exposed (i.e. less than 30 days).

### *DESIGN CONSIDERATIONS*

- Useful where vegetation cannot be immediately established due to the season.
- Should be performed after final grading.
- Should be used in conjunction with other measures such as mulch
- Has limited impact on very sandy or rocky soil.
- Roughening should follow parallel to the site contours.

### *INSTALLATION & MAINTENANCE CONSIDERATION*

- Surface is considered roughened if depressions are created which, are at least 50 mm to 100 mm deep and about 100 mm to 150mm apart.
- A chisel or ripping instrument can be used in most soil conditions.
- On slopes steeper than 2:1, the tracks left by a bulldozer working perpendicular to the contour can leave acceptable horizontal depressions.
- Vehicles and equipment should not be driven over areas that have been roughened as these results in the creation of tracks which channel water down slopes and encourage runoff and erosion.

Figure illustrating surface roughening from Water Related Best Management Practices in the Landscape (NRCS/USDA, 1999) and University of Virgin Island Cooperative Extensions Service (2003).

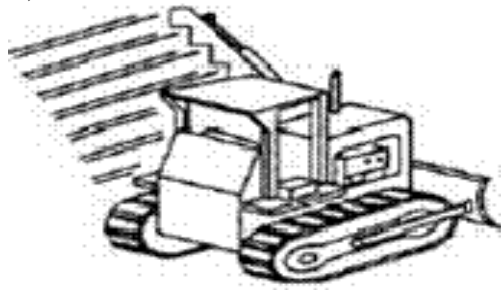

Slopes with grades < 2:1 - roughening should follow parallel to site contours

Slopes with grades  $> 2:1$  - tracking with machinery working perpendicular to the contour

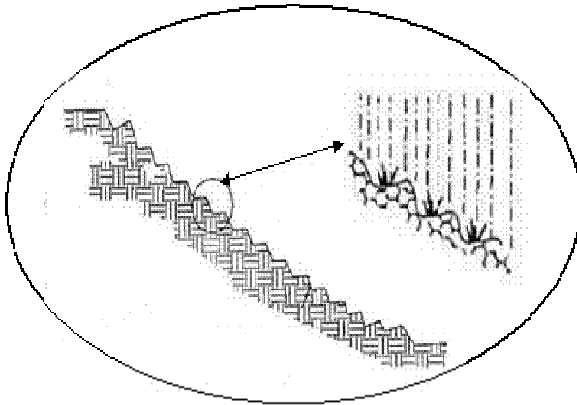
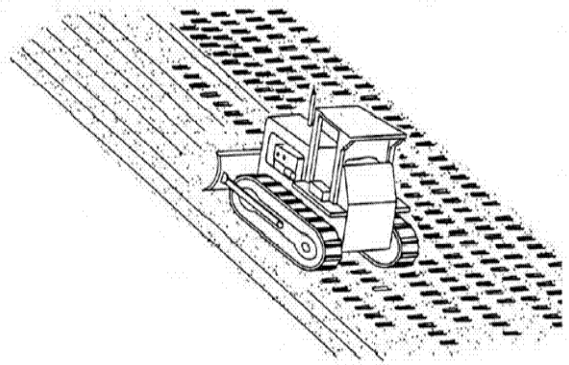

Roughening slope surfaces provides depressions and grooves that catch seed mulch and moisture and reduce runoff velocity.

## **EDGE SAVER™ SYSTEM**

### *DEFINITION & PURPOSE*

Edgesaver™ is a sustainable, customizable, scalable solution to a challenging area of eroded stream banks or pond banks. Eroded edges of ponds and streams are difficult to re-vegetate because it is hard to establish a solid edge to assist in the re-vegetation process. Loose products like soil or mulch are commonly added to edges only to find them eroded or washed away after the first rain. As such, the EdgeSaver™ are used to establish the edge against to which additional backfill can be added, without allowing it to fall into the stream or pond.

By allowing vegetation to become established prior to the next high water event, the system allows sediment to become deposited on top of and in vegetation during all subsequent events. In turn, the vegetation grows through these layers of sediment, establishing sustainability in a long-term system.

Growth media also offers some properties of chemical filtration (binding of metals and nutrients) and biological filtration (destruction of harmful substances) from the unique growth media blend contained in the netting materials.

### *APPLICATION*

The EdgeSaver™ system needs to include a good source of vegetation capable of being established and growing on the banks for a long-term solution. Although turf grasses are ideal at initial establishment and holding power for the Edgesaver™ and backfill media within the system, they should be considered along with other perennial or shrub species that are available by seed, live cuttings, plugs or stakes. Consideration for future habitat should include water flow, animals living in the area, concerns for spreading of invasive species, and aesthetic concerns with the surrounding area. Finally, long-term maintenance should be considered during plant selection stage to ensure that a minimal maintenance plan over the next several years helps to maintain the sustainable design of the EdgeSaver™ system.

This work shall consist of furnishing, installing, & maintaining an Edgesaver™ to offer containment of materials capable of supporting vegetation & preventing erosion along a stream or pond bank in the EdgeSaver™ system. Edgesaver™ will be used in combination with backfill media (see drawing below) where required to re-establish appropriate grades along banks of ponds or creeks. Backfill media will be able to support vegetation and blend in with the edge of the system (which is the Edgesaver™ itself).

### *DESIGN CONSIDERATION*

- Edgesaver™ shall be made on site using an approved multi filament, heavy duty or Safety Soxx of continuous, tubular HDPE, knitted, 9.38mm mesh netting material, filled with growth media and/or pea gravel (or 3/4 clear gravel), passing the specifications for Growth media/filter media products as outlined in growing media specifications.
- Edgesaver™ netting materials are available only from Filtrexx™ Canada Inc. and are the only Certified mesh materials accepted on site. Standard color coding systems for EdgeSaver™ programs include Black or Green. Other colors are only acceptable as approved by the engineer.
- Specifications for Media Mix With-in EdgeSaver™ Applications:

- Material used to fill the Edgesaver™ will be a blend of 50% growth media, 25% pea gravel or 3/4 clear gravel, & 25% filtermedia. The materials shall be appropriately blended prior to filling Edgesaver™. Pea Gravel (or equivalent sized aggregate, 3/4 clear gravel) will be obtained locally. Other customized filler materials may be used upon approval of either the Engineer or Conservation Authority. In some cases, the above specification will be used only for the bottom tier or most exposed layers of Edgesaver™. If a higher height is required, subsequent layers of Edgesaver™ may be added using 100% growth media in order to reduce weight and compression of bottom layers.
- Growth/filter Media - shall be weed free and derived from a well-decomposed source of organic matter. The growth media shall be produced using an aerobic composting process meeting or exceeding , M.O.E. 101, C.C.M.E. Type “A” and Type “AA” regulations, and Compost Quality Alliance (CQA) , including time and temperature data indicating effective weed seed, pathogen and insect larvae kill. The compost shall be free of any refuse, contaminants or other materials toxic to plant growth. Non-composted products will not be accepted. Test methods for the items below should follow USCC TMECC guidelines for laboratory procedures:
  - PH – 5.0-8.0 in accordance with TMECC 04.11-A, “Electrometric pH Determinations for Compost”
  - Particle size growth media – 99% passing a 25mm sieve, 90% passing a 18.5mm sieve and a minimum of 50% passing the 9.38mm sieve, in accordance with TMECC 02.02-B, “Sample Sieving for Aggregate Size Classification”.
  - Particle size filter media - 99% passing a 50 mm sieve and a minimum of 70% greater than the 9.38 mm sieve, in accordance with TMECC 02.02-B, “Sample Sieving for Aggregate Size Classification”.
  - Moisture content of less than 60% in accordance with standardized test methods for moisture determination.
  - Material shall be relatively free (<1% by dry weight) of inert or foreign man made materials.
  - Nutrient content shall be no greater than a 2-2-2- analysis of N-P-K using traditional nutrient analysis. However, at least 90% of the nitrogen shall be in the organic form, in order to reduce concerns about nutrient transport and leaching.
  - A sample shall be submitted to the engineer for approval prior to being used and must be a certified Filtrexx growth media / filter media mix which also complies with all local, provincial and federal regulations

### *INSTALLATION AND MAINTENANCE*

- Edgesaver™ will be used as a form of containment to create new edges within existing stream banks or pond banks. The Edgesaver™ filler material shall be pneumatically injected into the Edgesaver™ and filled on site.
- Edgesaver™ shall be placed at locations indicated on plans as directed by the Engineer. Edgesaver™ should be installed in a pattern that allows complete protection of the stream bank or pond bank area. When required, multiple Edgesaver™ will be placed in

a pyramid fashion or a stair stepped design to allow for the creation of terraces within the floodplain. (See figures below).

- Installation of Edgesaver™ must ensure a continuous length. When completing one section of Edgesaver™ filling, the next section shall be ‘sleeved’ over the first full section by a minimum of at least .3 (1’) meter overlap. A stake shall be placed in this overlap section, securing the two sections together.
- Standard sizes of Edgesaver™ will be 20cm, 30cm, 45cm & 60cm diameter products. Other diameters are available upon special request. In severe flow situations, larger Edgesaver™ may be recommended by the Engineer. For cases of pyramid stacking of Edgesaver™ or in terrace applications, larger diameter, heavier Edgesaver™ will be placed on the bottom and sequentially smaller Edgesaver™ placed on top.
- Edgesaver™ shall be constructed of a heavy duty multifilament, continuous, tubular HDPE, knitted, 9.38mm mesh netting material or Safety Soxx with a 1/16 weave and filled with a growing media that passes the criteria listed in growth media specification.
- EdgeSaver™ applications must be seeded during time of installation to create better anchoring to the soil and surrounding site. The choice of seed is nearly unlimited but Conservation Authority should be consulted in seed selection to assure native plant species prevail and that no invasive species are introduced. Live stakes (live cuttings) or plugs should be used in conjunction with seeding mixtures.
- All layers of Edgesaver™ should be staked to hold the Edgesaver™ against existing banks. As vegetation grows in over time it will establish root system into bank.
- Per the Engineer, terraces may be constructed on the stream bank, using a combination of Edgesaver™ and backfill media. This combination may be used to redirect some of the flows of stream banks in low flow conditions while allowing higher terrace areas to accept flood waters without damage to the channel itself. See figures below.
- The installer shall maintain the EdgeSaver™ system as functional at all times for a period of one year and it shall be routinely inspected. Normally, maintenance and repair of the EdgeSaver™ system is not a requirement due to the design being a sustainable system. However, if seed and vegetation does not grow into the Edgesaver™ then live staking or additional seed may need to be added at a later date. This can be done by adding a second backfill layer across the Edgesaver™ during low water (draw down) times. It may be necessary to water this second seeding if normal rainfall is not adequate.
- After the first season, when vegetation is established within the EdgeSaver™ system and growing well into the Edgesaver™, it may be necessary to consider adding other layers of Edgesaver™ to the design of the stream bank for further stabilization, or to add other choices of native plants that can be added as live stakes or plug plantings into the existing.
- Stabilization, or to add other choices of native plants that can be added as live stakes or plug plantings into the existing system. These choices should be made with the advice of the Conservation Authority familiar with such species as well as avoidance of invasive plants.
- Installer is required to be a certified as determined by Filtrexx Canada Inc. Certification shall be considered current if appropriate identification is shown during time of bid or at time of application.

Stake FilterSoxx™ as needed to retain in place.

Engineer to specify FilterSoxx™ diameter and placement based on application requirements.

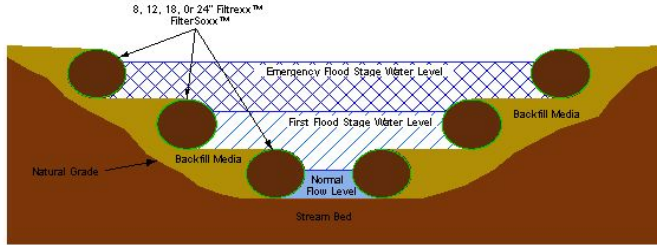

Filtrex™ "Terrace System"

LIVING WALL CAN BE USED ON ANY SLOPE, INCLUDING POND OR INTERCOURSE BANKS.

GRADE OR WATER

BOTTOM TO BE STAKED WITH 2"x2"x2" WOODEN STAKES AS REQUIRED.

COMPOST FILTER MATERIAL PER SPECIFICATIONS.

LIVE STAKE

LIVING SOCK™

400mm (16")

450mm (18")

300mm (12")

200mm (8")

0.50m (20") MIN.

1.5 TYP.

FILTREX™ COMPOST BLANKET

TYPICAL SOCK ARRANGEMENT ILLUSTRATED, WILL VARY TO SUIT SITE CONDITIONS AS PER ENGINEERS RECOMMENDATIONS.

**NOTES:**

1. ALL MATERIAL TO MEET FILTREX™ SPECIFICATIONS.
2. SEE DRAWING 7 FOR COMPOSITE BLANKET DEPTH.
3. BLANKET OPTIONS:
  - A. LIVING COMPOST TO BE SEED TO SUIT SITE CONDITIONS. FOR BEST RESULTS SEED TO BE MIXED INTO COMPOST PRIOR TO APPLICATION.
  - B. NON-LIVING COMPOST CAN BE PLACED WITHOUT SEED IF DESIRED.
4. LIVING SOCK™ COMPOST TO BE IMPREGNATED WITH ANNUAL SEED AND/OR OTHER SEED TO SUIT LOCAL SITE CONDITIONS. LIVE STAKING OF SOCKS THROUGHOUT THE LENGTH OF THE LIVING WALL, AS PER ARCHITECTS RECOMMENDATIONS.

**FILTREX™ CANADA**

324 GOVENORS RD. EAST  
PARIS ONTARIO  
CANADA N3L 3E1  
519-754-8296

**FILTREX™ INTERNATIONAL**

35481 GRAFTON EASTERN RD  
GRAFTON, OH  
USA 44044  
440-526-8041

LIVING WALL

DESIGN: R.D.B.	SCALE: NTS
CHECKED: R.D.B.	DRAWN: G.W.S.
SHEET: 4 of 7	DWG. No: T4
DATE:	

## **SEDIMENT CONTROL PRACTICES**

Sediment controls are the next barrier(s) of the multi barrier approach, and are implemented when areas are continually disturbed and/or when a finite amount of time is required before vegetative practices can be employed and become fully effective. The design and selection of site specific sediment control measures are primarily governed by drainage area, length of upstream gradient/slopes, soil cover/type, construction schedule, and season in combination with cost and effectiveness.

Sediment controls have been categorized into three sections:

1. Perimeter Controls;
2. Settling Controls; and,
3. Filtration Controls.

**Tables C2, C3, and C4** list the sediment control measures commonly utilized during the construction process. However, the list presented in this Guideline is not inclusive of all sediment control measures that exist.

## **PERIMETER CONTROLS**

Perimeter controls, such as sediment control fences and temporary flow diversion swales and/or dykes, are implemented to protect adjacent areas down gradient from the construction site and/or divert sediment laden runoff away from unprotected/disturbed slopes and areas. Perimeter controls are also utilized to convey runoff from external drainage away from a construction site. Although some perimeter controls may provide some sedimentation, its main function is to prevent sediment laden runoff from encroaching onto adjacent undisturbed areas and/or unprotected slopes.

**Table C2** on the next page lists the perimeter control measures commonly utilized during the construction process.



**Table C2. Perimeter Control Practices**

Name	OPSD Reference	Applicability					Applications	Temporary	Permanent	Reference Page	
		Slopes	Streams/Rivers	Surface Drainage ways	Table Lands	Borrow/Stockpile					Adjacent Property
Sediment/Silt Fence	219.130	√			√	√	√			C-24	
Interceptor Swale/Dike					√	√	√		√	C-27	
SiltSoxx		√			√	√	√			C-29	
Vehicle Tracking Control/Mud Mat					√				√	C-32	
Vehicle Wheel Washers					√				√	C-34	
Channel Soxx				√	√				√	√	C-35

## SEDIMENT/SILT CONTROL FENCE

### *DEFINITION & PURPOSE*

This measure consists of a non-woven synthetic fabric material (geotextile) stretched across and attached to supporting post and wire fence. The non-woven geotextile must be entrenched. This measure does NOT filter runoff, but acts as a linear barrier creating upstream ponding which allows soil particles to settle out thereby reducing the amount of soil leaving a disturbed area. The sediment control fence also decreases the velocity of sheet flow and low to moderate level concentrated flows.

The use of snow fence as structural support for the sediment fence should be discussed with the local Conservation Authority, and plans revised accordingly.

### *APPLICATION*

Sediment control fencing should be implemented along the perimeter and on the up-gradient side of sensitive areas, stream and river corridors, and at the base of moderate slopes. Silt fence is intended to treat moderate sheet flow, and is not suitable to treat concentrated flows, or substantial amounts of overland flow.

A separate fence (not necessarily a silt fence) may be utilized at a high point of a site and at areas to delineate between work areas and sensitive areas.

### *DESIGN CONSIDERATIONS*

- Geotextile material should be woven with a weave density of 270R or equivalent;
- Sediment/silt control fences should NOT be used in creeks or other areas of highly concentrated flows as it will not be able to allow for ponding of water for sediment removal and will fail structurally under high flows;
- Structural fencing must be used to back the sediment fence. A reinforced sediment fence also doubles as a limit of work fence;
- Prefabricated sediment control fence products with wooden stakes already attached to geotextile are not preferred since they are not structurally stable and are incapable of deep water ponding;
- Maximum allowable slope lengths and grades:

<u>Grade</u>	<u>Length</u>
2:1	15 metres
3:1	25 metres
4:1	40 metres;
- Maximizing the pond volume increases the amount of sediment to be trapped, therefore fences must be located and installed:
  - ⇒ along the contour and not on up and down slopes;
  - ⇒ with end sections constructed up the slope to stop runoff from flowing around the ends of the fence (e.g. flanking); and,
  - ⇒ on the flat area away from the toe of a slope.
- Vegetative buffer strips to be provided down gradient of sediment fencing according to the following criteria:
  - ⇒ > 3 m for perimeter fencing;

- ⇒ > 15 m for fencing adjacent to a warm water watercourse (as identified by local Conservation Authority or MNR staff); and,
- ⇒ > 30 m for fencing adjacent to a coldwater watercourse supplemented with a second row of fencing 2 metres beyond the initial row (as identified by local Conservation Authority or MNR staff).
- Refer to OPSD 219.13 for the Heavy Duty Silt Fence Barrier and illustrated on the following page.

#### *INSTALLATION & MAINTENANCE CONSIDERATIONS*

- The proper installation of a sediment control fence is critical to its functionality. See the figures below for an example of a properly installed sediment fence;
- The geotextile material must be stretched tight when installing the material and the bottom edge buried a minimum of 150 mm with compaction of the excavated backfill. Diagonal bracing of the posts is recommended where deep ponding is experienced or anticipated;
- Clear granular stone placement can be used in frozen as well as un-frozen conditions to assist in filtering sediment laden waters;
- Any failure must be repaired immediately;
- Sediment control fence must be inspected regularly, and after every rainfall, to identify failed sections. If wet conditions persist, repairs must be undertaken to restore the integrity of the fencing;
- When sediment accumulates to half the height of the geotextile it should be removed and disposed of in a controlled area; and,
- A supply of sediment control fence should be kept on site to provide for quick repairs or the installation of an additional fence as required.

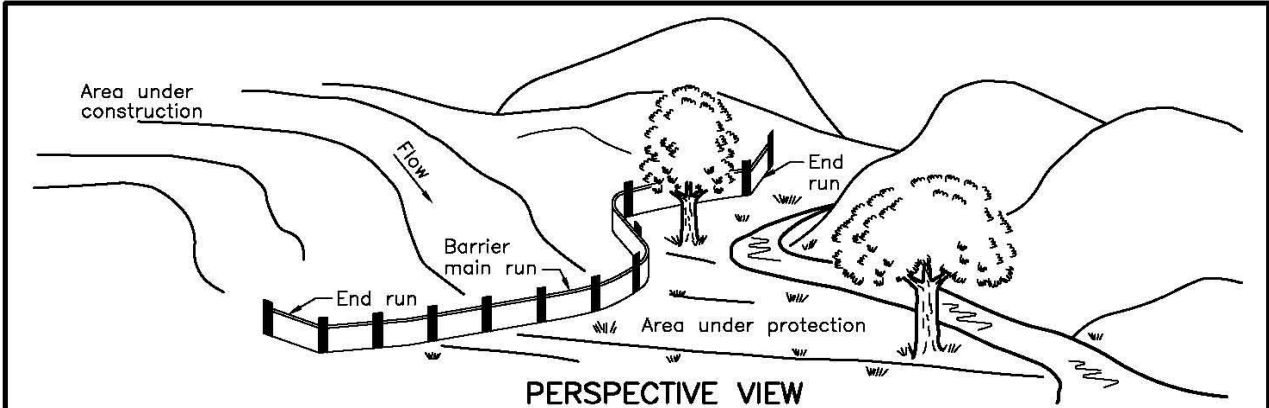

PERSPECTIVE VIEW

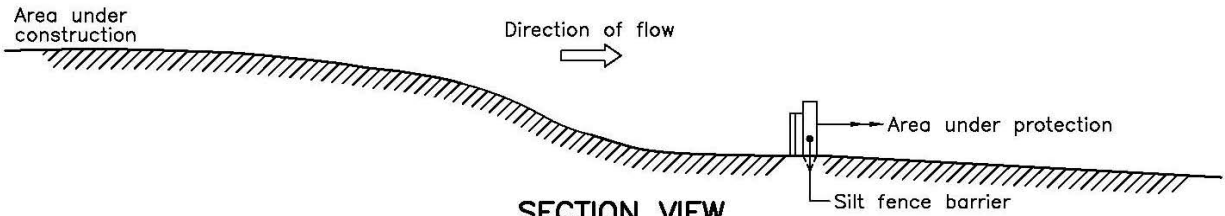

SECTION VIEW

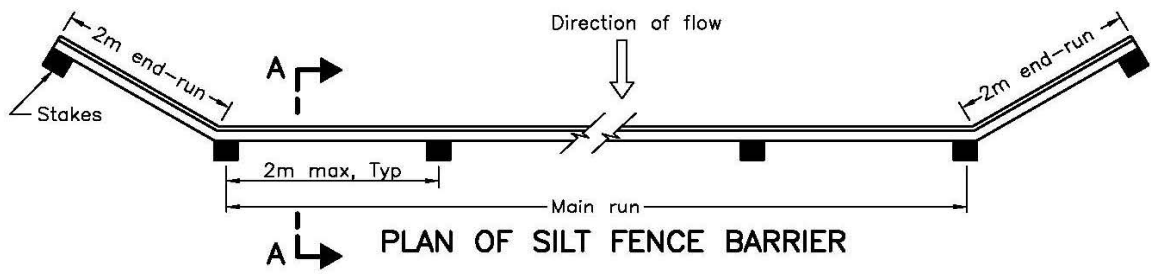

PLAN OF SILT FENCE BARRIER

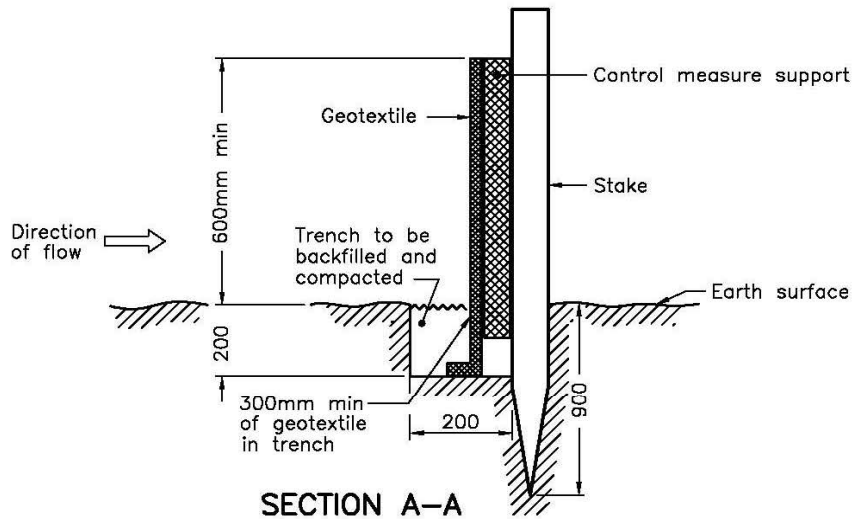

SECTION A-A

**NOTE:**

A All dimensions are in millimetres or metres unless otherwise shown.

ONTARIO PROVINCIAL STANDARD DRAWING		1996 02 01	Rev	
<h1>HEAVY DUTY SILT FENCE BARRIER</h1>		Date		
		<h2>OPSD - 219.130</h2>		

## **INTERCEPTOR/DIVERSION SWALES AND DYKES**

### *DEFINITION & PURPOSE*

Interceptor swales and dykes involve the use of temporary grading of conveyance systems to collect and convey runoff away from unprotected/disturbed slopes, as well as convey runoff from disturbed slopes to a downstream sediment trap or basin/pond. Diversion swales/dykes reduce sheet and rill erosion on slopes to allow re-vegetation to proceed and slopes to stabilize.

### *APPLICATION*

Can be applied to intercept surface water runoff from undisturbed or disturbed slopes and convey flows to the appropriate discharge or treatment location. Diversion dykes and swales are intended to convey small flows along low-gradient channels. Should be considered along all toe of slopes and adjacent to valley and stream corridors.

### *DESIGN CONSIDERATIONS*

- Temporary diversion dykes and swales should be constructed on the top of long or steep slopes or whenever the up-gradient tributary drainage area exceeds two (2) hectares. (See figure below).
- Flow diversions should be considered when:
  - $S^2 * L > 0.75$  where,
    - S = slope of the upslope tributary area (metres/metre); and,
    - L = length of the upstream slope (metres)
- Diversions should be considered at the top of all slopes in excess of 3:1;
- Dykes should be compacted and constructed with maximum 2:1 side slopes. Swale channel slopes should not be greater than 2:1;
- Concentrated flows from diversions should not be allowed to flow down unprotected slopes, and should be directed to an appropriate sediment control device such as a sediment trap or pond/basin;
- Velocities within a swale should be controlled with rock check dams to prevent channel erosion. (e.g. velocities greater than 1.2 m/s will erode the invert of grassed diversions); and,
- Swales/Ditches should be vegetated if possible. Riprap stabilization may be required at the inlet/outlet to prevent erosion.

### *INSTALLATION & MAINTENANCE CONSIDERATIONS*

- The grading of interceptor swales/dykes can be undertaken at any time during construction, provided that the runoff water is directed to an appropriate sediment control device; and,
- If the diversion is anticipated to exist for more than 30 days, it should be seeded. In some cases sod or rip-rap may be required to protect the invert from down cutting.

Example of Interceptor Swale/Dyke. Figures from Surface Water Design Manual, Appendix D (King County Department of Natural Resources, 1995); Water Related Best Management Practices in the Landscape (NRCS/USDA, 1999).

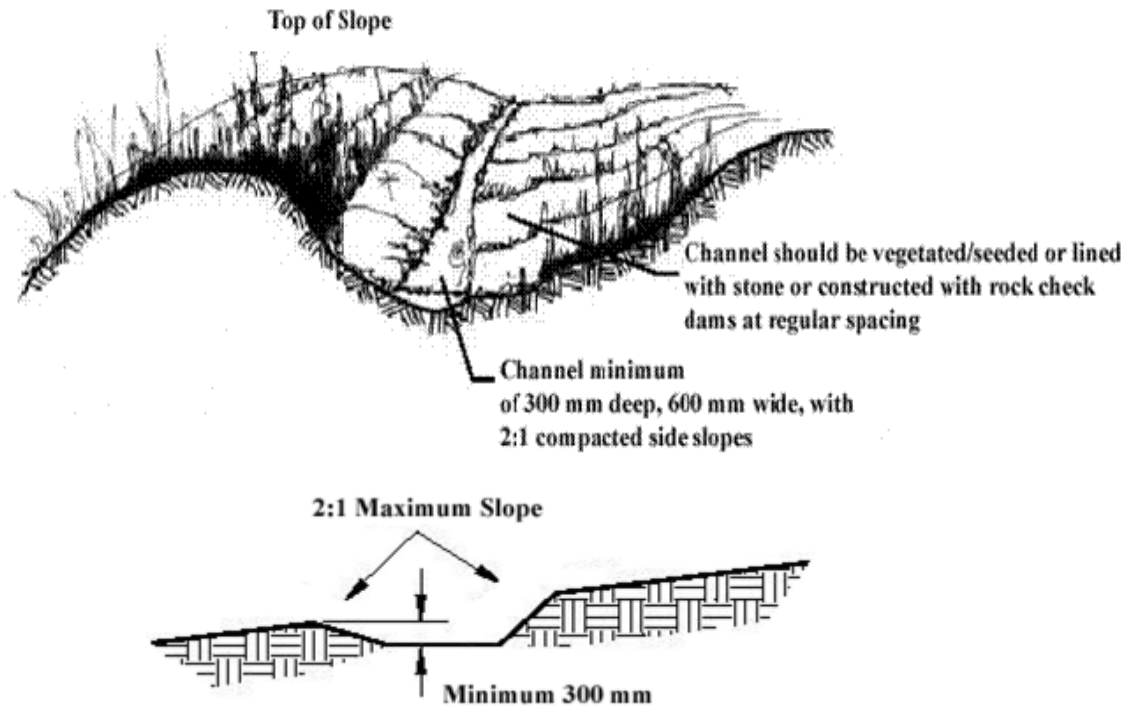

## **SILTSOXX™ FOR PERIMETER EROSION CONTROL**

### *DEFINITION & PURPOSE*

Siltsoxx™ is a sediment-trapping device using filtermedia materials applied with a pneumatic blower device or equivalent. Siltsoxx™ trap sediment by filtering the water passing through the Siltsoxx™ also allowing water to pond, creating a settling of solids behind Siltsoxx™.

### *APPLICATION*

Siltsoxx™ is to be used in any area requiring sediment control to keep runoff in the form of sheet flow. The use of Siltsoxx™ apply to areas of high sheet erosion, on steep slopes up to and exceeding a 2:1 slope, and in other disturbed areas of construction sites requiring sediment control. Siltsoxx™ may also be used in sensitive environmental areas, where migration of aquatic life is impeded by the use of other sediment controls. Filter Media used in Silt Soxx™ also has the ability to bind various contaminants contained in runoff.

### *DESIGN CONSIDERATION*

The sedimentation removal process associated with Siltsoxx™ involves both filtering and deposition from settling. This is different than other methods using only ponding for deposition of sediment. Ponding occurs when water flowing to the Siltsoxx™ accumulates faster than it can flow through the SiltSoxx™. However, installation technique is important for them to work effectively.

For most applications, standard Siltsoxx™ size for perimeter control is 30mm

- **Level Contour:** Place Siltsoxx™ on level contours to assist in dissipating flow into sheet flow rather than concentrated flows. Do not construct Siltsoxx™ that concentrate runoff or channel water. Sheet flow of water should be perpendicular to the Siltsoxx™ at impact and relatively un-concentrated.
- **Flat Slopes:** When possible, place Siltsoxx™ at a 1.5m or greater distance away from the toe of the slopes in order for the water coming from the slopes to maximize space available for sediment deposit. When this 1.5m distance is not available due to construction restrictions, a second Siltsoxx™ may be required (see drainage area chart below).
- **Flow around ends:** In order to prevent water from flowing around the ends, Siltsoxx™ must be constructed with the ends pointing upslope so they are at a higher elevation.
- **Vegetation:** For permanent areas, seeded Siltsoxx™ allows vegetation to be established directly in the Soxx and immediately in front and back of the Soxx at a distance of 1.5m. Vegetation on and around the Siltsoxx™ will assist in slowing down water for filtration. The option of adding vegetation will be at the discretion of the Engineer and Conservation Authority. No other soil amendments or fertilizer are required for vegetation establishment.

Siltsoxx™ - Maximum Drainage Area  
Based on Slope and Slope Length

	Slope	Slope Length (linear meters)	Siltsoxx™ Required (Diameter)
0%-2%	Flatter than 50:1	76.2m	30cm
2%-10%	50:1-10:1	38.1m	30cm
10%-20%	10:1-5:1	30.48m	30cm
20%-33%	3:1-2:1	15.24m	45cm
>50%	>2:1	7.62m	45cm

- Siltsoxx™ should be installed parallel to the base of the slope or other affected area. In extreme conditions (e.g. 2:1 slopes), a second Siltsoxx™ shall be constructed at the top of the slope. (Consult with manufacture for details).
- If the Siltsoxx™ is to be left as a permanent filter or part of the natural landscape, it may be seeded at time of installation for establishment of permanent vegetation. The Engineer will specify seed requirements in conjunction with Conservation Authority.

**Dispersing flow:**

Sheet flow and runoff should not exceed height of Siltsoxx™ capacity in most storm events. If overflow of the Siltsoxx™ is a possibility, larger SiltSoxx™ should be constructed.

- Siltsoxx™ shall either be made on site or delivered to the jobsite using Siltsoxx™ materials in a 5 mil monofilament or heavy duty multifilament continuous, tubular, HDPE 9.38mm knitted mesh netting material, filled with filtermedia passing the requirements for filtermedia products as outlined in specs.
- Standard Siltsoxx™ color coding systems include Yellow and Black 20.cm, Orange and Black 30cm, or Red and Black 45cm striped mesh netting with 9.38mm mesh openings.

*INSTALLATION & MAINTENANCE CONSIDERATIONS*

- This work shall consist of furnishing, installing, maintaining and dispersing (if needed) a water permeable filtermedia Siltsoxx™ to contain soil erosion and sediment by removing soil particles from water moving off site into adjacent waterways or storm water drainage systems.
- The installer shall remove sediments collected at the base of the Siltsoxx™ when they reach 1/2 of the exposed height of the Siltsoxx™, or as directed by the Engineer.
- Siltsoxx™ should be inspected weekly and after all rainfall and/or snowmelt events to make sure they hold their shape and are producing adequate flow through. For purposes of longer-term sediment control objectives, Siltsoxx™ can be seeded at the time of installation to create an additional vegetative filtering component.
- When construction is completed on site, the Siltsoxx™ may be dispersed with a loader, rake, bulldozer or other device to be incorporated in the soil or left on top of the soil for final seeding to occur. The mesh netting material will be disposed of in normal trash container or removed by the Installer.

Specifications for FilterMedia Derived from Composted Products.

- Filtermedia derived from Compost used for Siltsoxx™ shall be weed free and derived from a well-decomposed source of organic matter. The compost shall be produced using an aerobic composting process meeting or exceeding , M.O.E. 101, C.C.M.E. Type “A” and Type “AA” regulations, and Compost Quality Alliance Program



(C.Q.A.) including time and temperature data indicating effective weed seed, pathogen and insect larvae kill. The compost shall be free of any refuse, contaminants or other materials toxic to plant growth. Non-composted products will not be accepted. Test methods for the items below should follow USCC TMECC guidelines for laboratory procedures:

- PH – 5.0-8.0 in accordance with TMECC 04.11-A, “Electrometric pH Determinations for Compost”
- Particle size – 99% passing a 50mm sieve and a minimum of 70% greater than the 9.38mm sieve, in accordance with TMECC 02.02-B, “Sample Sieving for Aggregate Size Classification”. (In the field, the product commonly requested is between 25mm and 50mm particle size.)
- Moisture content of less than 60% in accordance with standardized test methods for moisture determination.
- Material shall be relatively free (<1% by dry weight) of inert or foreign man made materials.
- A sample shall be submitted to the engineer for approval prior to being used and must be a certified Filtrexx filter media which also complies with all local, provincial and federal regulations.
- Installer is required to be certified as determined by Filtrexx Canada Inc. Certification shall be considered current if appropriate identification is shown during time of bid or at time of application.

Example of Silt Soxx for Perimeter Control.



## **VEHICLE TRACKING CONTROL/MUD MATS**

### *DEFINITION & PURPOSE*

When construction vehicles enter onto existing paved, public roads, provisions must be made to prevent the transport of sediment in the form of mud and dirt, onto the paved surface. This sediment can enter natural bodies of water by way of unprotected storm inlets in areas which have already been developed. A stabilized vehicle access and egress point must be constructed of coarse granular material, to reduce the transport of debris. See figures below for example of a mud mat.

### *APPLICATION*

The mud mat should be built at the entranceway of construction site where the site is greater than one (1) hectare in size and/or subject to grading and fill movement/placement activities in close proximity to the entrance.

### *DESIGN CONSIDERATIONS*

- Stone pad must be a minimum of 20 metres in length and the full width of the entrance;
- The pad should be a minimum of 300 mm thick, but 450mm thickness is recommended. The pad should be underlain with a geotextile (or graded aggregate filter) and consist of 50 mm diameter clear stone for the first 10 metres (extending from the street) and the remainder of the length to consist of 150 mm diameter clear stone;
- In some cases, municipal inspectors may deem wash racks necessary as illustrated in the figures below; and,
- In the case that the access crosses a culvert or ditch, sediment fencing or approved equivalent should be installed along the edges of the access to prevent sediment from being washed away with runoff.

### *INSTALLATION & MAINTENANCE CONSIDERATIONS*

- The granular material will require periodic replacement as it becomes contaminated by vehicle traffic;
- Sediment shall be cleaned from public roads at the end of each day;
- Sediment shall be removed from public roads by shovelling or sweeping and disposed of properly in a controlled sediment disposal area; and,
- Storm inlets both on and in proximity of the site shall be protected with inlet control measures prior to site development and road cleaning activities.

### *NOTES*

- Additional measures such as wheel washing systems may be required along with a mud mat to ensure sediment from a construction site will not be transported off the site via the exiting construction vehicles.
- For construction sites not capable of constructing a mud map at the vehicle access point, a wheel washing system is essential in preventing sediment from being transported off the site.

- moby dick is a company providing several wheel washing systems for vehicles exiting a construction site. Their website lists these various products – [www.mobydick.com](http://www.mobydick.com).

Example of a mud mat from Surface Water Design Manual, Appendix D (King County Department of Natural Resources, 1995)

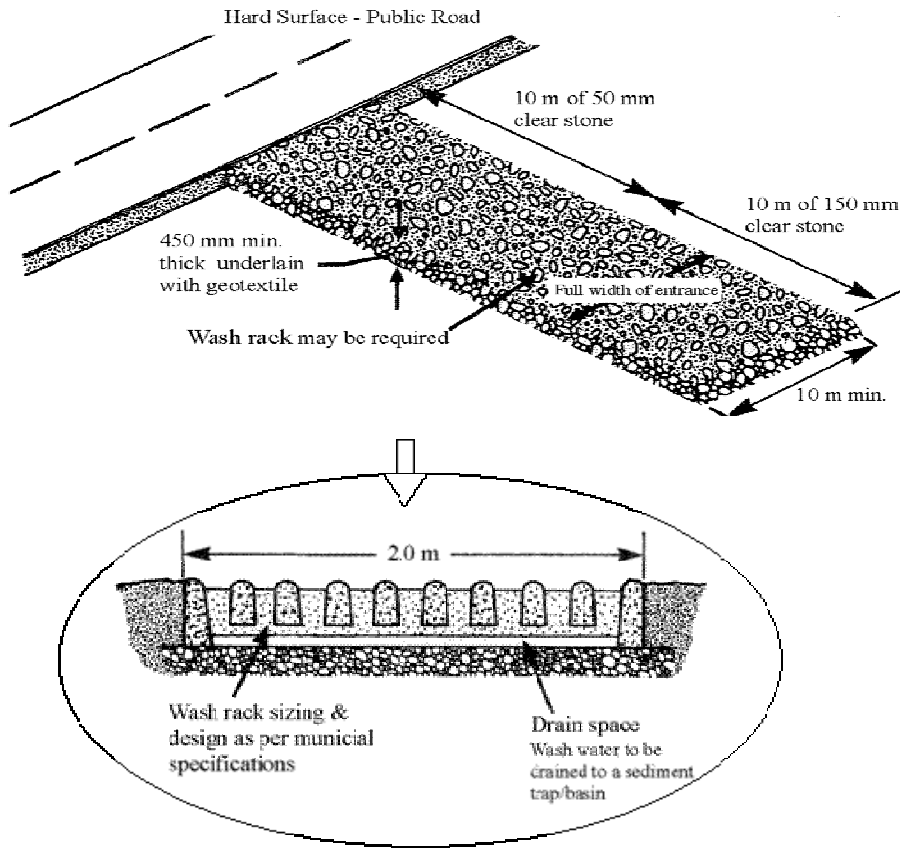

## VEHICLE WHEEL WASHING SYSTEMS

### *DEFINITION & PURPOSE*

Wheel washing systems are additional measures to ensure sediment will not be transported from a construction site to existing adjacent roads. If sediment is transported from a construction site to the existing paved roads, this sediment can enter natural bodies of water by way of unprotected storm inlets in areas which have already been developed. See figures below for examples of wheel washing systems.

### *APPLICATION*

The wheel washing system should be placed at the entranceway of construction site which is subject to grading and fill movement/placement activities in close proximity to the entrance. A wheel washing system can be used in combination with a mud mat or alone where a mud mat is not constructed.

### *DESIGN CONSIDERATIONS*

- The particular model of wheel washing system is dependant on the number of vehicles required for cleaning on a daily basis and the degree (heavy, middle or light) of sediment to be cleaned for each vehicle;
- moby dick is one of many existing companies that supply such wheel washing systems. See moby dick's website [www.mobydick.com](http://www.mobydick.com) for more information of their products.

### *INSTALLATION & MAINTENANCE CONSIDERATIONS*

- See manufacturer's details for installation/placement and maintenance of the wheel washing system.

Figures illustrating some wheel washing systems from moby dick website ([www.mobydick.com](http://www.mobydick.com))



## **CHANNEL SOXX™**

### *DEFINITION & PURPOSE*

Channel Soxx™ are to be used in place of rip rap or other channel designs for directing water off site and preventing invert erosion on a channel or swale. Channel Soxx™ is normally seeded during the time of installation, which allows them to become part of the living landscape.

### *APPLICATION*

Use Channel Soxx™ in place of rip rap for channels when concerned about maintenance of the rest of the slopes. In many cases, maintenance of the rip rap/grass zone is challenging and can be an area of concern for liability. The Channel Soxx™ allow permanent vegetation, along with growing media and mesh netting, to provide the conveyance for water for many years. This design is similar to 'sod waterways' commonly used in agricultural applications, except that the Channel Soxx™ offer additional reinforcement from the netting materials. The Channel Soxx™ also allows less sediment discharge due to intimate ground contact and the depth of growing media within the Channel Soxx™ system. Growth media used in the Channel Soxx™ also has the ability to bind various contaminants contained in runoff.

### *DESIGN CONSIDERATIONS*

- Channel Soxx™ is used to handle similar flows as those with rip rap or other tools. However, they are not for the bottoms of raging rivers or extremely rough waters. Typically, Channel Soxx™ is applied on 3:1 or steeper grades and should be worked into the slope stabilization plan via the engineer or architect.
- In general, Channel Soxx™ is placed edge to edge and will grow together if installed correctly. Proper installation will achieve a 30cm width per Channel Soxx installed. Depth should be about 75mm.
- The Channel Soxx™ should be installed with the edges of the top of the Channel being under the water flow. It is imperative to get the water flowing on top of the system at the top of the slope. Channel Soxx™ is installed using a special filling device that flattens the Channel Soxx™ into approximately 10cm deep x 30cm wide configurations (see figures below).
- The ends of the Channel Soxx™ should be staked to hold the product in place. Additional stakes should be placed at a minimum of every 3m

### *INSTALLATION & MAINTENANCE CONSIDERATIONS*

- Channel Soxx™ will be used as a form of drainage channel protection on construction sites, which require protection against sediment-laden water or high runoff rates created from construction site configurations.
- Channel Soxx™ will be placed at locations indicated on plans as directed by the Engineer.
- Standard sizes of Channel Soxx™ should be 30cm width products (see figures below) and a depth of about 10cm. In severe flow situations, the Engineer may recommend larger Channel Soxx™.

- Channel Soxx™ shall be constructed of a heavy duty multi-filament, continuous tubular HDPE, knitted, 9.38mm mesh netting material and filled with a growing media product that passes the criteria listed in growing media specs.
- If the Channel Soxx™ becomes clogged with debris and sediment, they shall be maintained so as to assure a proper drainage and water flow into the drainage channel.
- Channel Soxx™ are to be left as a permanent part of the landscape, Channel Soxx™ need to be seeded during time of installation as specified by the Engineer. Seed will not be necessary if installation is temporary.
- The contractor shall maintain Channel Soxx™ in a functional condition at all times and it shall be routinely inspected.

#### Specifications for Growth Media Derived from a Composted Product.

- Growth Media used for Channel Soxx™ shall be weed free and derived from a well-decomposed source of organic matter. The compost shall be produced using an aerobic composting process meeting or exceeding M.O.E. 101, C.C.M.E. Type “A” and Type “AA” regulations, and Compost Quality Alliance Program (C.Q.A) including time and temperature data indicating effective weed seed, pathogen and insect larvae kill. The compost shall be free of any refuse, contaminants or other materials toxic to plant growth. Non-composted products will not be accepted. Test methods for the items below should follow USCC TMECC guidelines for laboratory procedures:
  - PH – 5.0-8.0 in accordance with TMECC 04.11-A, “Electrometric pH Determinations for Compost”
  - Particle size – 99% passing a 25mm sieve, and a minimum of 90% passing a 18.75mm sieve, in accordance with TMECC 02.02-B, “Sample Sieving for Aggregate Size Classification”
  - Moisture content of less than 60% in accordance with standardized test methods for moisture determination.
  - Material shall be relatively free (<1% by dry weight) of inert or foreign man made materials.
  - A sample shall be submitted to the engineer for approval prior to being used and must be a certified Filtrexx filter media which also complies with all local, provincial and federal regulations.
  - Installer is required to be certified as determined by Filtrexx Canada Inc. Certification shall be considered current if appropriate identification is shown during time of bid or at time of application.

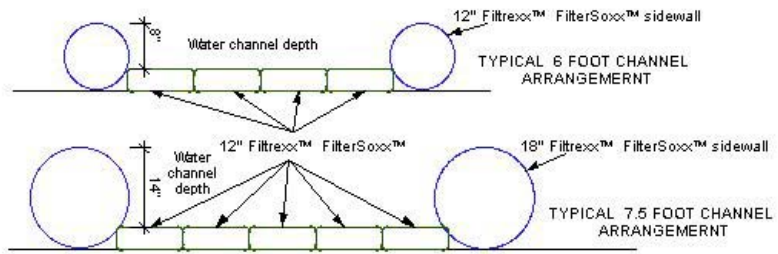

END VIEW

Engineer to specify sidewall Filtrexx™ size and channel depth based on installation requirements.

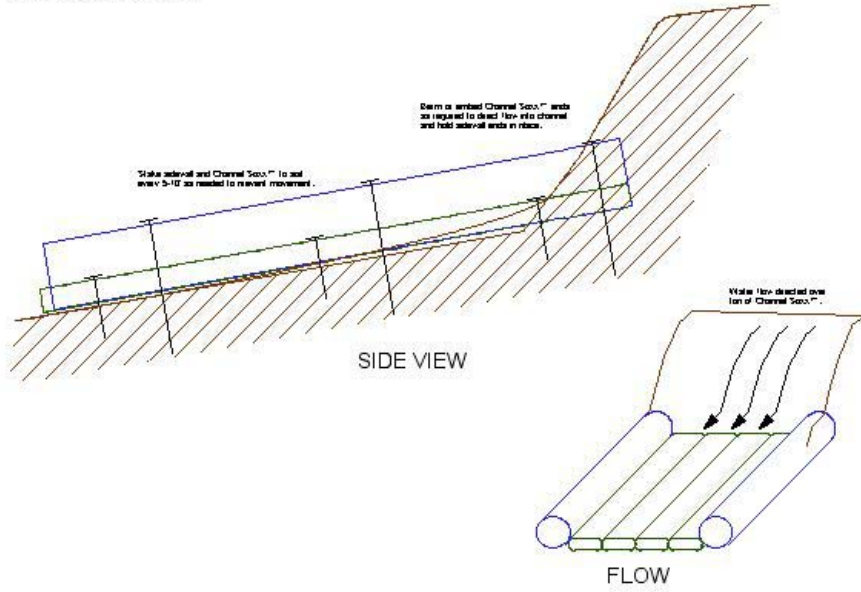

SIDE VIEW

## **SETTLING CONTROLS**

Settling controls allow for a reduction in runoff velocity, resulting in the settlement of suspended soil particles from the sediment laden runoff. Extended detention and/or filtration sediment control measures will be needed to remove finer particles.

Extended detention is the process of allowing the suspended solids to settle, through detaining the sediment laden water for an extended period of time within a settling basin. There is usually a slowly controlled outflow release rate for the temporary sediment pond to allow for the extended detention time.

In keeping with the multi barrier approach, settling controls such as a temporary sediment control pond should not be the only ESC control implemented for a development site. Erosion prevention controls and additional sediment controls should be included in the ESC Plan to ensure effective erosion and sediment controls.

Implementation of the temporary sediment pond at the location of the Ultimate stormwater management facility should be discussed with the governing Conservation Authority, and Plans prepared accordingly.

**Table C3** on the next page lists the settling control measures commonly utilized during the construction process.



**Table C3. Settling Control Practices**

Name	OPSD Reference	Applicability					Applications	Temporary	Permanent	Reference Page
		Slopes	Streams/Rivers	Surface Drainage ways	Table Lands	Borrow/Stockpile				
Ditch/Swale Sediment Trap				√	√		These are placed in surface drains just before water leaves the site, enters a watercourse or a ditch inlet. Can be planned with rock check dams to reduce velocities and flow should pass through stabilized vegetation before entering to water body.	√		C-40
Sediment Traps	219.220 / .240	√		√	√	√	Traps are designed to intercept sediment-laden runoff and to trap suspended sediment. Constructed by excavation or by berming. Traps have limited capacity and must be inspected regularly.	√		C-40
Rock Check Dam	219.210 / .211	√			√		Check dams can be constructed of rock, aggregate-filled sandbags or logs to reduce flow velocities in drainage channels. Regular inspection and maintenance of such structures is essential to their effective operation.	√		C-42
Ditch Chexx		√			√		Continuous tubular knitted, mesh netting filled with filtermedia and placed across ditch areas to reduce velocities and filter sediment.	√		C-46
Filter Berms				√	√		Sediment trapping device using filter media derived from composted materials. Traps sediment by filtering water passing through the berm and allowing water to slow down, creating a settling of solids.	√	√	C-49
Straw/Wood Fibre Logs				√	√		Intended to be utilized on slopes to minimize displacement of sediments, in channels as small ditch checks and to restrict sediment laden flow from inlets and drains.	√		C-53
Straw Bales				√	√		Permeable barriers consist of a line of organic material, implemented along the contours of mild slopes to assist in reducing flow and increase the interception of suspended sediments. Contact the local Conservation for approval to utilize this measure.	√	√	C-55
Sediment Control Ponds		√	√	√			Sediment control ponds reduce flow velocities and encourage sediment deposition. Sediment ponds require maintenance to remove sediment and must be designed by qualified personnel.	√		C-56
Storm Drain Outfall Protection					√		Energy dissipating devices placed at the base of a pipe or channel outlet to prevent scour at these outlets and minimize the potential for downstream systems by reducing the velocity of concentrated flows.	√		C-60
Bulkheads within storm sewers				√	√		They are set at the bottom of storm sewers and about half the height of the sewer. Bulkheads assist in reducing flow velocities to allow for sediment particles to settle out from the construction site runoff. Blocks usually constructed of brick and mortar and usually placed at the downstream end of a maintenance hole for ease of clean out.	√		

## **SEDIMENT TRAPS**

### *DEFINITION & PURPOSE*

A sediment trap is a depression area allowing runoff to pond. The depression area is formed by constructing an earth embankment across a drainage ditch, or by excavating a depression below original grade. The sediment trap consists of a stable spillway outlet. The purpose of the trap is to detain runoff from disturbed areas for a long enough period of time to allow for a majority of the coarser suspended soil particles in the runoff to settle out.

### *APPLICATION*

To be implemented on sites with disturbed drainage areas up to two (2) hectares in size.

### *DESIGN CONSIDERATIONS*

- Provide a minimum of 125 cubic metres of storage volume per hectare of contributing drainage area;
- A stable open channel spillway must be designed by a qualified professional. If the trap is to remain in place for more than one season it should be sized to safely pass the 1 in 100 year storm;
- The lining of the channel can consist of rock or other suitably stable material underlain with filter fabric (270R geotextile or approved equivalent) or self filtering stone. Erosion protection will be required immediately downstream of the spillway;
- Sediment trap may be formed by constructing a berm or by excavating a basin completely or partially;
- The trap should be a minimum of 1.0 metres deep to avoid re-suspension of previously settled out sediment. Trap depths of greater than 2.0 metres should be avoided due to safety concerns. If the maximum 2.0 m depth is unavoidable, the municipality may require a fence around the trap to prevent access to it;
- The basin outlet should be directed with the flow in the downstream direction; and,
- Sediment trap and overflow configurations are illustrated in the figures below.
- Refer to OPSD 219.220 for the Excavated Sediment Trap. A copy of OPSD 219.220 is located on the following page.

### *INSTALLATION & MAINTENANCE CONSIDERATIONS*

- Proper compaction control must be used when constructing the embankment to ensure its stability;
- The spillway installation is critical to prevent failure of the structure during high flows and all specifications provided by the designer must be implemented;
- Sediment traps should be inspected on a weekly basis and after all rainfall and significant snowmelt events. Any damages to the sediment trap(s) should be repaired in 24 hours of the discovery of the damage.; and,
- When sediment accumulates to half the height of the sediment trap it should be removed and disposed of in a controlled area and stabilized. Caution must be used to avoid damaging the embankment or spillway during this maintenance operation.

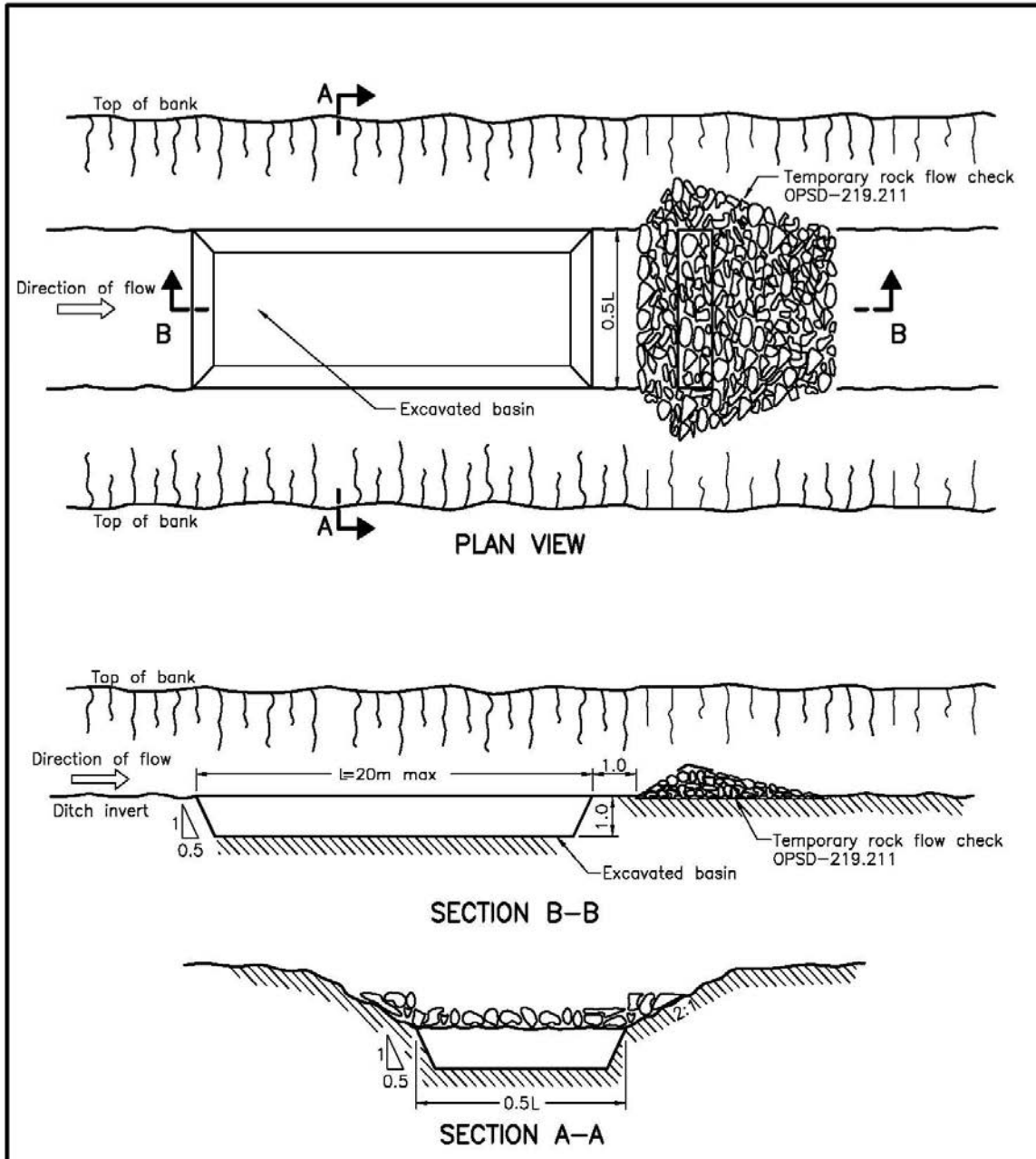

**NOTES:**

- A Ditch cross section upstream or downstream of sediment trap may be flat bottom or 'V' shaped.
- B All dimensions are in millimetres or metres unless otherwise shown.

ONTARIO PROVINCIAL STANDARD DRAWING	1996 02 01   Rev	
<b>EXCAVATED SEDIMENT TRAP</b>	Date _____	
<b>OPSD - 219.220</b>		

## ROCK CHECK DAMS

### *DEFINITION & PURPOSE*

A rock check dam consists of granular material placed temporarily across a ditch, minor stream or drainage way. Its purpose is to reduce the velocity of runoff to reduce the erosion of ditch and drainage way inverts. Rock check dams allow for little ponding and is therefore not very effective in settling out sediment, particularly fine soil particles.

### *APPLICATION*

Rock check dams are applied across intermittent and low flow swales, ditches, and diversion channels. Additional sediment control measures should also be incorporated with rock check dams.

### *DESIGN CONSIDERATIONS*

- Rock is to be placed with a layer of smaller stone under a layer of larger stone. The layers of different stone sizes are to be separated by a non-woven geotextile.
  - ⇒ Bottom layer: should consist of 50 millimetre diameter stones and stacked to 0.45 meters high;
  - ⇒ Middle layer/material: non-woven geotextile; and,
  - ⇒ Top layer: should consist of 150 millimetre diameter stones that extend from the conveyance system invert (i.e. swale invert) to the top of the bottom layer. The top layer should be a minimum 100 millimetres thick and should form a low center spillway. The spillway should be a minimum of 0.3 meters below the top of the channel to prevent erosion flanking.
- The geotextile should be extended along the bottom of the swale/channel on the downstream side and anchored with the second layer of stone to form an underlying “spill apron”.
- The rock is to be piled with a maximum upstream slope of 2:1 and a maximum downstream slope of 4:1.
- Centre height of dam should not exceed 1.0 m. The centres of the dam should be notched to concentrate flow towards the centre (approximately 0.15 m). The outer sides of the dam that transition into the ditch slopes should be at 0.5 m higher than the centre of the dam to avoid any potential for the side slopes of the dam to be undermined.
- A series of check dams should be used for swales/ditches with a significant gradient or slope length.
- Height of subsequent check dams must be equal to the elevation of the base of the previous dam.
- Refer to OPSD 219.210 for the Temporary Rock Flow Check with V-Ditch and OPSD 219.211 for the Temporary Rock Flow Check. A copy of OPSD 219.210 and 219.211 are located on the following pages.

### *INSTALLATION & MAINTENANCE CONSIDERATIONS*

- Sediment monitoring and removal required from the base of the structure when accumulation becomes visible.

- Inspection should take place weekly and after every rainfall and significant snowmelt events to identify any problem areas.
- Repair of the sediment trap should take place within 24 hours of determining the deficiency.

*NOTES*

- Rock check dams do not serve as in-stream sediment traps.
- Rock check dams should only be used in channels or swales that are designed for drainage areas not exceeding 3 ha. These are not appropriate for natural watercourses and should not be used for lined or vegetated channels.

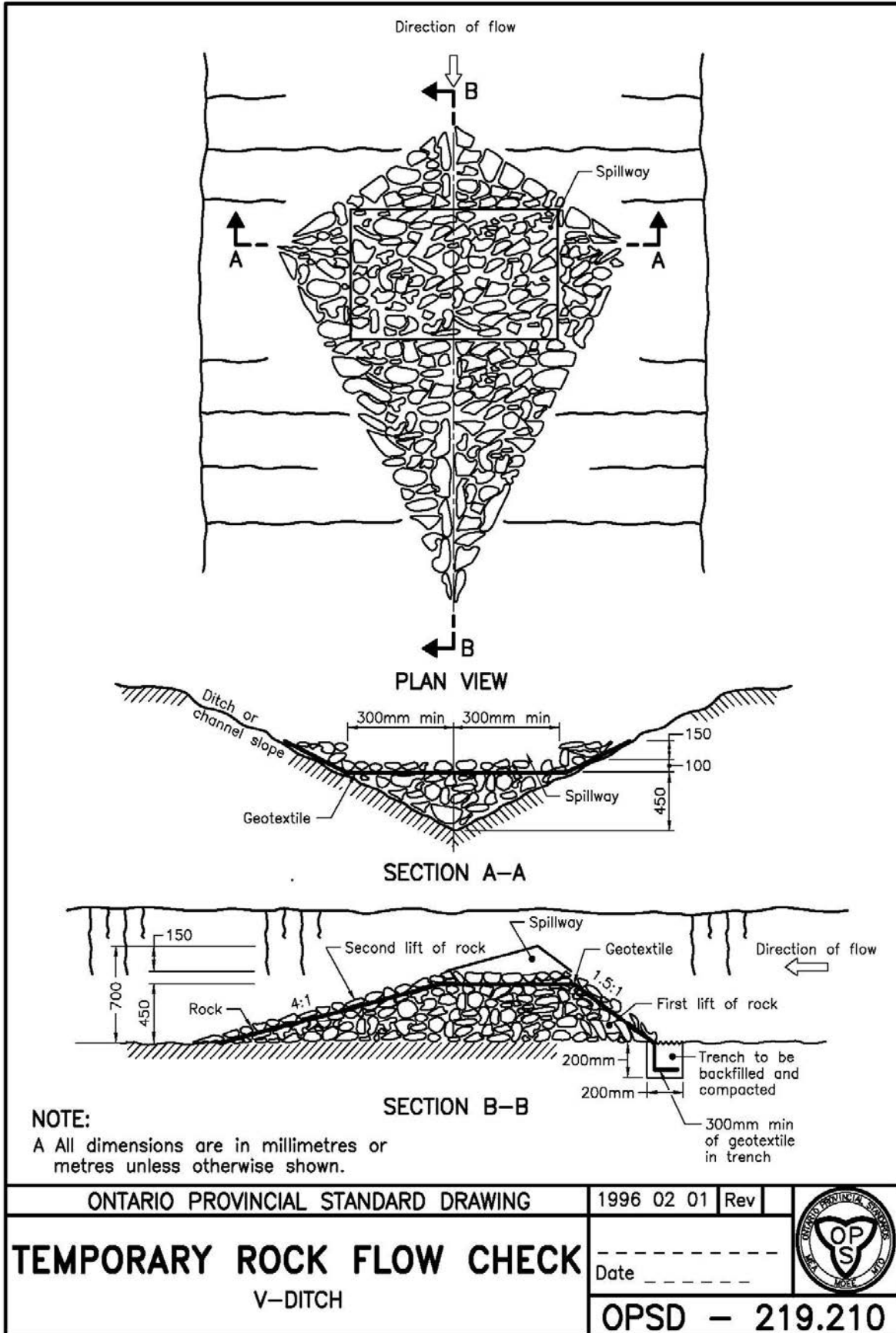

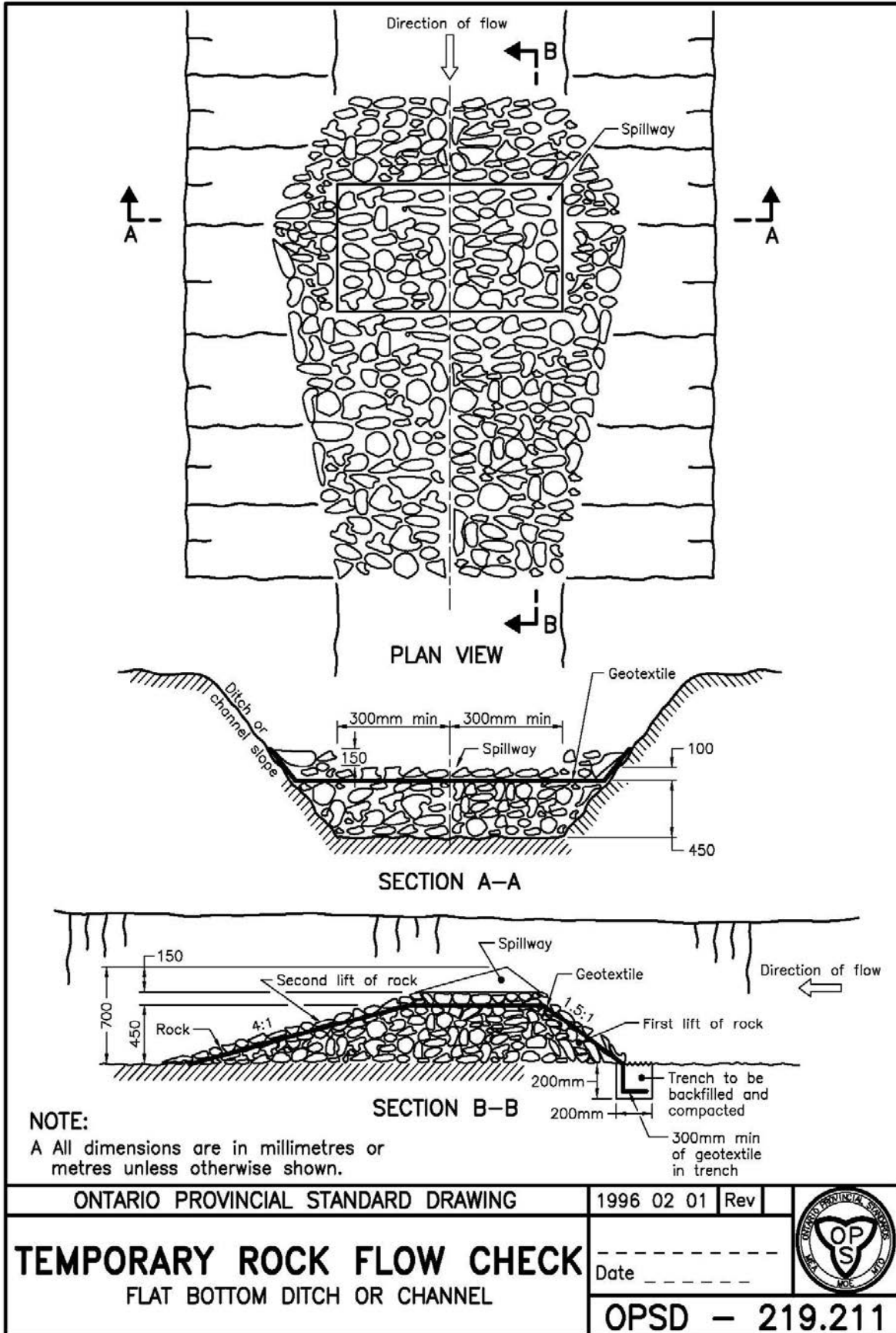

ONTARIO PROVINCIAL STANDARD DRAWING		1996 02 01	Rev	
<b>TEMPORARY ROCK FLOW CHECK</b> FLAT BOTTOM DITCH OR CHANNEL		Date		
		OPSD - 219.211		

## **DITCH CHEXX™**

### *DEFINITION & PURPOSE*

Ditch Chexx™ are made from a filtermedia derived from a composted material contained in a mesh tube of various diameters for varying situations and directional flows. Ditch Chexx™ are used for filtering channel flow of sediment-laden waters generated from construction activities during storm events. Ditch Chexx™ filter and help reduce runoff velocities, creating a settling and filtering effect of sediment laden stormwater runoff. Filter Media used in Ditch Chexx™ also has the ability to bind various contaminants contained in runoff.

### *APPLICATION*

Ditch Chexx™ can be used in place of traditional methods of ditch erosion and sediment control tools, including straw bales, and rock check dams. Ditch Chexx™ can be used in small open channels where it is necessary to slow down the velocity of the stormwater prior to leaving the ditch area. Applications include temporary runoff channels, swales, and other areas that may be used as an integrated approach to overall erosion and sediment control plans for the project.

### *DESIGN CONSIDERATIONS*

- Ditch Chexx™ are not reliable as the only form of erosion and sediment control for an entire project. Ditch Chexx™ are normally 30cm or 45cm in diameter and are limited in the amount of water they can treat due to limited height and width across the channel. Ditch Chexx™ should be used in combination with other tools as an integrated approach.
- In general, Ditch Chexx™ should be installed every 6-23m, depending on the slope and amount of water requiring treatment. In areas of high rainfall, closer spacing is required. In dryer areas, larger spacing between Ditch Chexx™ and smaller diameters may be sufficient.
- In general, the Ditch Chexx™ should be installed with the ends of the materials forming a “U”-shaped figure towards incoming channeled water, so as to create a ponding effect rather than a deflecting, or water shedding, effect. In the event water runs over the Ditch Chexx™ in severe storm events, the water should run over the center of the Ditch Chexx™, not around the ends.
- Minimally, the ends and center of the Ditch Chexx™ should be staked to hold the product in place. Under severe flow situations and longer installations, more stakes may be required at an interval of every 1m.
- Ditch Chexx™ are able to achieve a large ‘footprint’ of ground contact when installed properly. Ditch Chexx™ should be pressed into place to achieve a maximum contact with the ground surface.

### *INSTALLATION & MAINTENANCE CONSIDERATIONS*

- Ditch Chexx™ will be used as a form of drainage channel protection and sediment removal on construction sites, which require protection against sediment laden water.
- Installation of Ditch Chexx™ will ensure that the Ditch Chexx™ exceed the normal drainage area by at least 1.2m on the upslope of both banks. The Ditch Chexx™ will be anchored to the soil using stakes.



- Standard sizes of Ditch Chexx™ for normal protection should be 30cm diameter. In severe flow situations, the Engineer may recommend larger Ditch Chexx™ of 45cm or 60cm. Ditch Chexx™ can be stacked one on top of the other, if additional height is required.
- Ditch Chexx™ shall be constructed of a continuous, tubular, HDPE 9.38mm knitted mesh material and filled with a filtermedia that passes the criteria listed in specification section.
- If the Ditch Chexx™ becomes clogged with debris and sediment, they shall be maintained so as to assure a proper drainage and water flow into the drainage channel.
- For areas where Ditch Chexx™ are to be left as a permanent part of the landscape, Ditch Chexx™ may be seeded during time of manufacture to create a ‘living’ Ditch Chexx™. For seeding options, the Engineer shall specify seed type and seeding rate.
- The installer shall maintain Ditch Chexx™ in a functional condition at all times and it shall be routinely inspected.
- The installer shall remove sediments collected at the base of the Ditch Chexx™ when they reach 1/3 of the exposed height of the Ditch Chexx™, or as directed by the Engineer. Alternatively, another Ditch Chexx™ may be installed behind the first, slightly upslope, to minimize soil disturbance activities.
- The Ditch Chexx™ will be dispersed on site when no longer required, as determined by the Engineer. The netting material will be disposed of in a normal trash container or removed by the installer.

#### Specification for FilterMedia Derived from a Composted Product

- Filter Media- shall be weed free and derived from a well-decomposed source of organic matter. The focus on product selection should be for water flow and movement more than a growing media. The filtermedia shall be produced using an aerobic composting process meeting or exceeding , M.O.E. 101, C.C.M.E. Type “A” and Type “AA” regulations, and Compost Quality Alliance Program (CQA), including time and temperature data indicating effective weed seed, pathogen and insect larvae kill. The filter media shall be free of any refuse, contaminants or other materials toxic to plant growth. Non-composted products will not be accepted. Test methods for the items below should follow USCC TMECC guidelines for laboratory procedures:
  - PH – 5.0-8.0 in accordance with TMECC 04.11-A, “Electrometric pH Determinations for Compost”
  - Particle size – 99% passing a 50mm sieve and a minimum of 70% greater than the 9.38mm sieve, in accordance with TMECC 02.02-B, “Sample Sieving for Aggregate Size Classification”. (In the field, the product commonly requested is between 12.5mm and 50mm particle size.)
  - Moisture content of less than 60% in accordance with standardized test methods for moisture determination.
  - Material shall be relatively free (<1% by dry weight) of inert or foreign man made materials.
  - A sample shall be submitted to the engineer for approval prior to being used and must be a certified Filtrexx filter media which also complies with all local, provincial and federal regulations.

- Installer required to be certified as determined by Filtrexx Canada Inc. Certification shall be considered current if appropriate identification is shown during time of bid or at time of application.

Example of Ditch Chexx™.



## **FILTER BERMS**

### *DEFINITION & PURPOSE*

Filter Berms are sediment trapping devices using filter media derived from composted materials applied with a pneumatic blower device or equivalent. Filter Berms trap sediment by filtering water passing through the berm and allowing water to slow down, creating a settling of solids. Filter Media used in Filter Berms has the ability to bind various contaminants contained in runoff.

### *APPLICATIONS*

Filter berms are to be used in any area requiring sediment or erosion control where runoff is in the form of sheet flow. The use of filter berms apply to areas of high sheet erosion, on steep slopes up to a 2:1 slope, and in other disturbed areas of construction sites requiring sediment control. Filter berms may also be used in sensitive environmental areas, where there is migration of aquatic life, including turtles, salamanders etc.

### *DESIGN CONSIDERATIONS*

Filter berms control erosion by trapping sediment and slowing water that filters through the berm. This will create temporary ponding during heavy rains. It is possible to drive over filter berms during construction, but these areas should be immediately repaired with a rake or shovel. Continued heavy construction traffic will reduce the effectiveness of the berms.

The sedimentation removal process associated with filter berms involves both filtering and deposition from settling. This is different than other methods using only ponding for deposition of sediment. Ponding occurs when water flowing to and through the filter berm accumulates faster than it can flow through the berm. However, installation technique is especially important for them to work effectively.

For most applications, it is important to maintain a 2:1 base to height ratio for the berms to be dependably stable.

- *Level Contour:* Place berms on level contours to assist in dissipating flow into sheet flow rather than concentrated flows. Do not construct berms, which concentrate runoff or channel water. Sheet flow of water should be perpendicular to the berm at impact and relatively non-concentrated.
- *Flat Slopes:* When possible, place berms at a 1.5m or greater distance away from the toe of the slopes in order for the water coming from the slopes to maximize space available for sediment deposit (see figure below). When this 1.5m distance is not available due to construction restrictions, a second berm may be required (see drainage area chart below).
- *Flow around ends:* In order to prevent water flowing around the ends of the berms, the ends of the berm must be constructed pointing upslope so the ends are at a higher elevation.
- *Vegetation:* For permanent areas, seeded berms allow vegetation to be established directly on the berm and immediately in front and back of the berm at a distance of 1.5m. Vegetation on and around the berms will assist in slowing down water for filtration. The option of adding vegetation will be at the discretion of the Engineer. No other soil amendments or fertilizer are required for vegetation establishment.

- Drainage area:

Filter Berm Maximum Drainage Area  
Based on Slope and Slope Length

	Slope	Slope Length (linear meters)	Berm Size Required (Height x width)
0%-2%	Flatter than 50:1	76.2m	0.3 x 0.6m
2%-10%	50:1-10:1	38.1m	0.3 x 0.6m
10%-20%	10:1-5:1	30.48m	0.3 x 0.6m
20%-33%	3:1-2:1	15.24m	0.4 x 0.8m
>50%	>2:1	7.62m	0.46 x 0.9m

(Note: a 0.3m high berm is interchangeable with a 0.3m diameter Siltsoxx)

- Dispersing flow: Sheet flow and runoff should not exceed height of berm capacity in most storm events. If overflow of the berm is a possibility, larger berms should be constructed, or other possible sediment control tools may be used. Alternatively, a second berm may be constructed or used in combination with growth media erosion control blankets to prevent sediment from moving.

### INSTALLATION & MAINTENANCE CONSIDERATIONS

This work shall consist of furnishing, installing, maintaining and dispersing (if needed) a water permeable filter berm to contain soil erosion and sediment by removing soil particles from water moving off site into adjacent waterways or storm water drainage systems.

Filter berms should be inspected weekly and after all rainfall and/or snowmelt events to make sure they hold their shape and are producing adequate flow through. If ponding becomes excessive, berms should be dispersed and reconstructed. For purposes of long-term sediment control objectives, berms can be seeded at the time of installation to create an additional vegetative filtering component.

When construction is completed on site, the berms may be dispersed with a loader, rake, bulldozer or other device to be incorporated in the soil or left on top of the soil for final seeding to occur. No other disposal is required.

- Filter berms will be placed at locations indicated on plans as directed by the Engineer. Berms should be installed parallel to the base of the slope or other affected areas construct a 0.3m high by 0.6m wide berm. In extreme conditions (e.g. 2:1 slopes), a second berm shall be constructed at the top of the slope. (See berm size indications in the drainage chart below)
- If the berm is to be left as a permanent filter or part of the natural landscape the filter media berm may be seeded at time of installation for establishment of permanent vegetation. The Engineer will specify seed requirements.
- Filter berms are not to be used in direct flow situations or in runoff channels. If direct water flow is possible, use DitchChexx™ in similar diameters and stake according to specifications.
- The installer shall remove sediments collected at the base of the berm when they reach 1/3 of the exposed height of the berm, or as directed by the Engineer. Alternatively, an additional berm may be placed upslope of the existing berm in order to minimize sediment disturbance activities.
- The filter berm will be dispersed on site when no longer required, as determined by the Engineer.

### Specifications for Filter Media Derived from Composted Materials

- Filtermedia derived from compost used for Filter Berms shall be weed free and derived from a well decomposed source of organic matter. The filtermedia shall be produced using an aerobic composting process meeting or exceeding M.O.E. 101, C.C.M.E. Type “A” and Type “AA” regulations, and Compost Quality Alliance (C.Q.A) Program including time and temperature data indicating effective weed seed, pathogen and insect larvae kill. The filtermedia shall be free of any refuse, contaminants or other materials toxic to plant growth. Non-composted products will not be accepted. Test methods for the items below should follow USCC TMECC guidelines for laboratory procedures:
  - PH – 5.0-8.0 in accordance with TMECC 04.11-A, “Electrometric pH Determinations for Compost”
  - Particle size – 99% passing a 50mm sieve and a minimum of 70% greater than the 9.38mm sieve, in accordance with TMECC 02.02-B, “Sample Sieving for Aggregate Size Classification”. (In the field, the product commonly requested is between 12.5mm and 50mm particle size).
  - Moisture content of less than 60% in accordance with standardized test methods for moisture determination.
  - Material shall be relatively free (<1% by dry weight) of inert or foreign man made materials.
  - A sample shall be submitted to the engineer for approval prior to being used and must be a certified Filtrexx filter media which also complies with all local, provincial and federal regulations.
  - Installer is required to be certified as determined by Filtrexx Canada Inc. Certification shall be considered current if appropriate identification is shown during time of bid or at time of application.

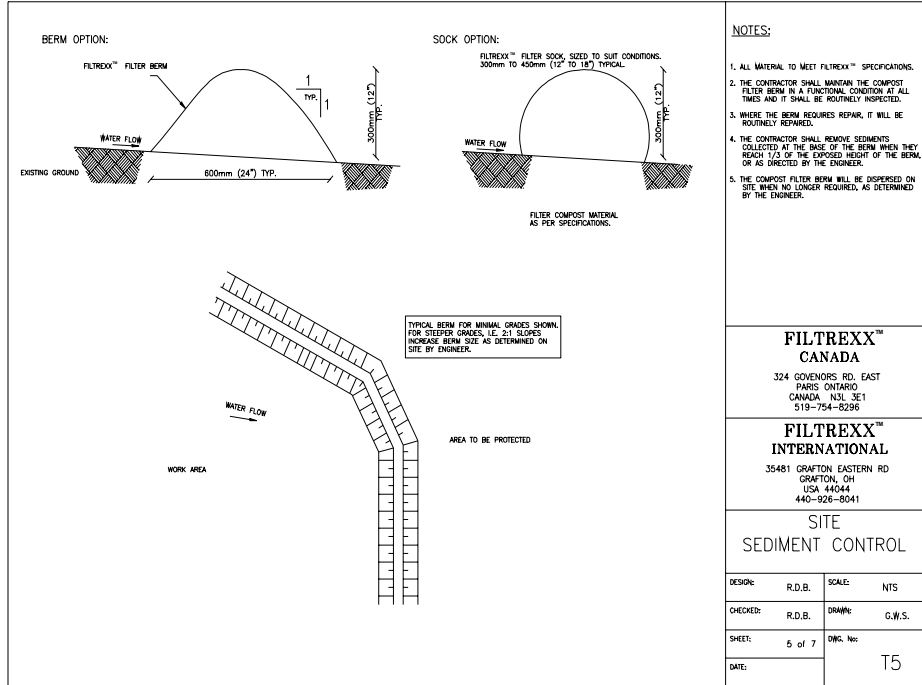

## **STRAW LOGS – WOOD FIBRE LOGS**

### *DEFINITION & PURPOSE*

Permeable barriers consist of a line of organic material, implemented along the contours of mild slopes (< 5 %) to assist in reducing flow and increase the interception of suspended sediments.

Straw logs are in rolled tubular form and are designed to reduce hydraulic energy and filter sediment laden flow in channels and on slopes. The logs are flexible to conform to the soil surface.

### *APPLICATION*

Straw logs are intended to be utilized on slopes to minimize displacement of sediments, in channels as small ditch checks and to restrict sediment laden flow from inlets and drains.

Straw logs must be installed in conjunction with RECP Apron or blanket (Rolled Erosion Control Product) according to standard manufacturer's installation instructions.

The local Conservation Authority must be contacted to confirm the use of straw logs within it's jurisdiction for sediment control.

### *DESIGN CONSIDERATIONS*

- Straw logs consist of a certified 100% agricultural, weed free, straw matrix confined by a tubular (0.50 x 0.50 Heavy Duty) synthetic netting that is closed at ends with Hog Rings or tied. Available in 23cm, 30cm, and 50cm diameters with a standard length of 3m – other sizes are also available.
- Straw logs require a minimum of 0.3m of upstream apron and 0.6m of downstream apron for installation. Subsequent down slope rows of logs should be spaced appropriately for site conditions to minimize acceleration of flow.
- Straw log seams should be offset to ensure continuous filtration.
- Straw logs must be staked with a minimum length stake of 25mm x 25mm x 0.6m (sandy or loose soil may require longer stakes).
- Straw log must maintain intimate contact with ground surface over entire application.

### *INSTALLATION AND MAINTENANCE CONSIDERATIONS*

- Site must be fully prepared (free of debris, rocks etc) to ensure log remains in contact with slope.

### *NOTES*

- Product certified by Western Excelsior Corp.

## EXCEL Straw Logs





## STRAW BALES

### *DEFINITION & PURPOSE*

Permeable barriers consist of a line of organic material, implemented along the contours of mild slopes (< 5 %) to assist in reducing flow and increase the interception of suspended sediments.

Straw bales can be oriented end to end and in multiple layers to form a consistent and continuous permeable barrier to flow.

### *APPLICATION*

Straw bales can be applied across constructed conveyance systems and along the contours of mild to gentle slopes. Straw bales should not be used alone, but should be used in combination with other controls for effective performance.

**The local Conservation Authority must be contacted to confirm the use of straw bales within it's jurisdiction for sediment control.**

### *DESIGN CONSIDERATIONS*

- Straw bales should be firmly butted together and staked with wooden stakes or T-bars. In ditches or swales, a second row of bales should be placed behind the first row, overlapping at the joints.
- To prevent flanking, bales should extend up the channel slopes a minimum of 1 metre above the high flow depth.
- Straw bales can be applied at the base of the slope, as well as the top of the slope for added protection.

### *INSTALLATION AND MAINTENANCE CONSIDERATIONS*

- Following their replacement/removal, straw bales can be broken apart and spread as mulch to promote vegetation establishment.

### *NOTES*

- Straw bales must be applied in combination with other controls (e.g. vegetated buffer strip, silt fence, silt soxx, filter fabric or approved equivalents).

Figures illustrating straw bales.

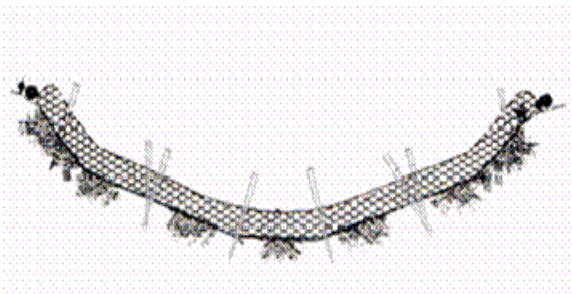

## SEDIMENT CONTROL PONDS/BASINS

### *DEFINITION & PURPOSE*

A sediment control pond/basin is a runoff storage area formed by constructing a compacted earth embankment or by excavating a depression across or at the end of a drainage path. The sediment control pond/basin consists of an outlet structure to control the stormwater release rate. Its purpose is to detain runoff long enough to allow the majority of soil particles to settle out of suspension. Sediment ponds/basins typically serve as an “end of pipe” control, which receive flows from other ESC controls and overland flow during extensive grading operations. (See following figures).

***Incorporating the sediment control pond at the location of the ultimate stormwater management pond must be discussed and approved by the local Conservation Authority.***

### *APPLICATION*

To be implemented on sites with disturbed drainage areas exceeding two (2) hectares in size. Sediment basins are typically capable of removing sediment as small as 4 microns. Location of the pond should be based on topography, the low point of runoff concentration that allows the maximum control of runoff from the disturbed areas.

### *DESIGN CONSIDERATIONS*

- Basin specifications and configurations are detailed in the figures below.
- Sediment ponds should have two components:
  1. Active Storage Volume:  
Should be designed with a minimum of 125 m<sup>3</sup>/hectare contributing drainage area with a minimum 48 hour drawdown time (minimum 75mm diameter orifice), and a minimum 4:1 L:W ratio of the pond; and,
  2. Permanent Pool Volume:
    - i. Minimum 125 m<sup>3</sup> storage volume/hectare drainage; or,
    - ii. Minimum 185 m<sup>3</sup> storage volume/hectare drainage area if L:W ratio is less than 4:1 or the drawdown time for active storage is less than 48 hours.
- ***The local Conservation Authority must be contacted to confirm the appropriate permanent pool volume.***
- A forebay should be provided for the sediment control pond and designed in accordance with the MOE SWM Planning and Design Manual, 2003.
- In addition to the initial sediment forebay, another forebay or silt/turbidity curtain should be constructed within the stormwater management pond and in series to the first forebay. The distance of the second forebay berm or curtain should be approximately half the distance between the initial forebay berm and the pond outlet structure.
- Velocity calculations must be submitted to ensure that settling velocities are achieved.
- A Hickenbottom riser outlet or approved equivalent must be used to release detained flows. The riser pipe must be covered with a layer of smaller clear stone (25 mm - 50mm) over a layer of larger size (150 mm - 200 mm) clear stones (See figure below). A minimum 75 mm diameter orifice is required as part of this outlet structure.

- The basin length to width ratio should be a minimum 4:1. A baffle may be required to increase the flow length to prevent potential short circuiting.
- Maximum 4:1 interior side slopes and maximum 2:1 exterior slopes.
- The basin should be a minimum of 1.0 metre deep to avoid re-suspension of previously settled out sediment and a mean depth of 1.0m to 2.0m and maximum depth of 3.0m.
- An emergency spillway must be designed by a qualified professional and it should be sized to safely pass the 1:100 Year storm event. Supporting calculations, reports and drawings must be provided. The lining of the spillway can consist of riprap or other suitably stable material underlain with filter fabric. Erosion protection will be required immediately downstream of the spillway.
- Sediment basins have a high trapping efficiency, fewer maintenance requirements and can function through more phases of construction. However, on-site and conveyance erosion and sediment control measures must be implemented with a proposed sediment control pond.

### *INSTALLATION & MAINTENANCE CONSIDERATIONS*

- Sediment ponds/basins must be constructed prior to any construction activities except for topsoil stripping and grading operations associated with the construction of the temporary ESC pond.
- Proper compaction control must be used when constructing the embankment to ensure its stability.
- Pond banks must be stabilized with vegetation once the excavation of the pond is complete.
- The emergency spillway installation is critical to preventing failure of the structure during high flows and all specifications provided by the designer must be followed.
- ***Sediment accumulation in the ponds must be measured a minimum of once every six (6) months. The pond will require cleaning when sediment accumulation reaches 50% of the forebay design capacity.***
- Sediment pond embankments, outlet, and spillway should be inspected weekly and after each rainfall and significant snowmelt events.
- In the case where the temporary sediment pond is in the location of the ultimate pond, and the construction of the subdivision is complete, the accumulated sediment within the pond must be removed and the permanent pool storage must be restored to the design level.

### *NOTES*

- At-source and conveyance ESC measures must be used in addition to sediment ponds to minimize the amount of sediment entering the sediment pond. Vegetative filter strips (minimum of 10 m length) are recommended at the outlet of the pond.

## Plan View of Sediment Control Pond

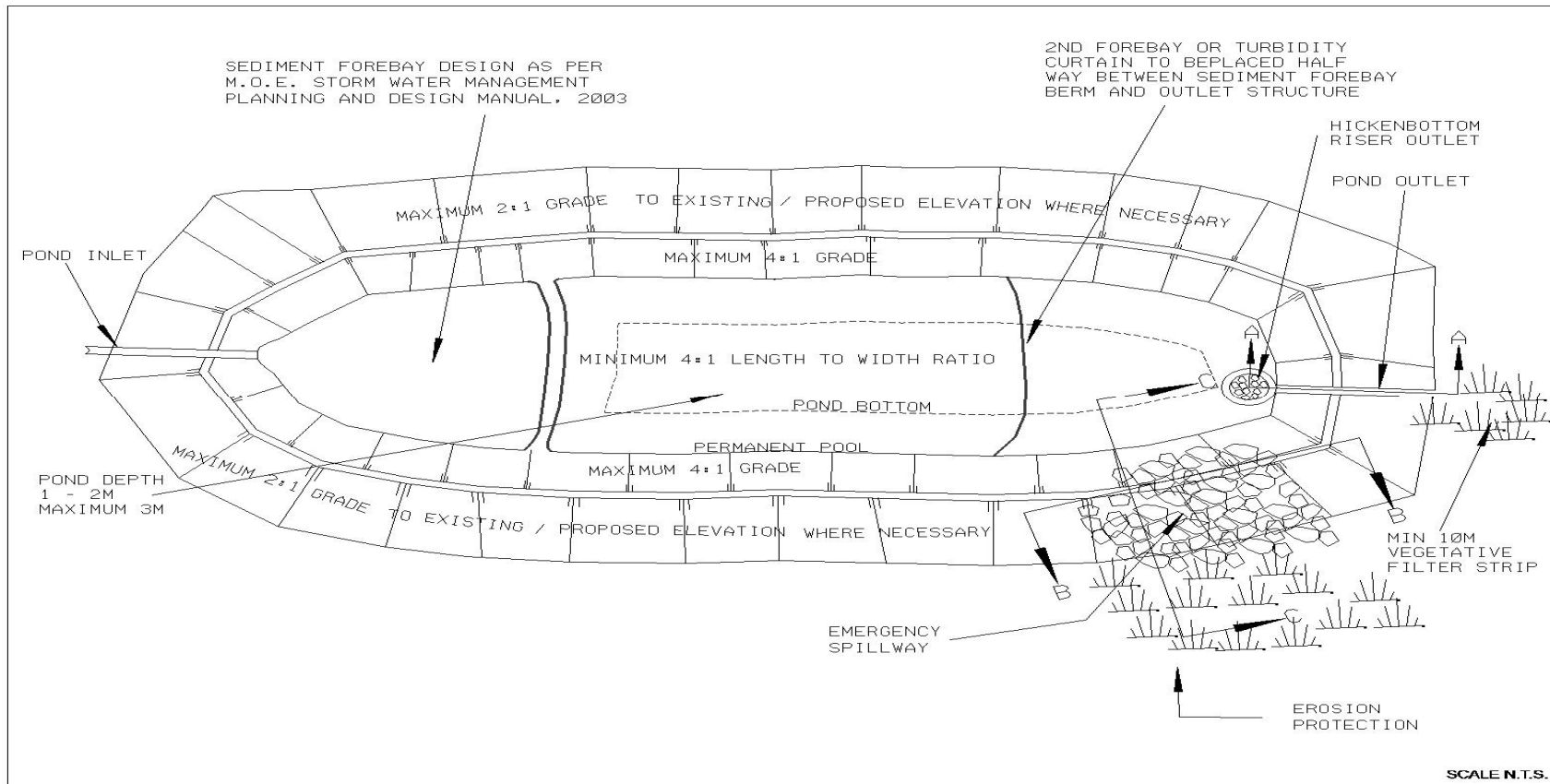

### Notes:

1. ***Pond side slopes to be stabilized immediately;***
2. Minimum 48 Hour drawdown time with minimum 75mm diameter orifice;
3. Active Storage Volume:  
Should be designed with a minimum of 125 m<sup>3</sup>/hectare contributing drainage area with a minimum 48 hour drawdown time (minimum 75mm diameter orifice) and minimum 4:1 L:W pond ratio; and,
4. Permanent Pool Volume:
  - i. Minimum 125 m<sup>3</sup>/hectare drainage area; or
  - ii. Minimum 185 m<sup>3</sup>/hectare drainage area if L:W ratio is less than 4:1 or the drawdown time for the active storage is less than 48 hours.

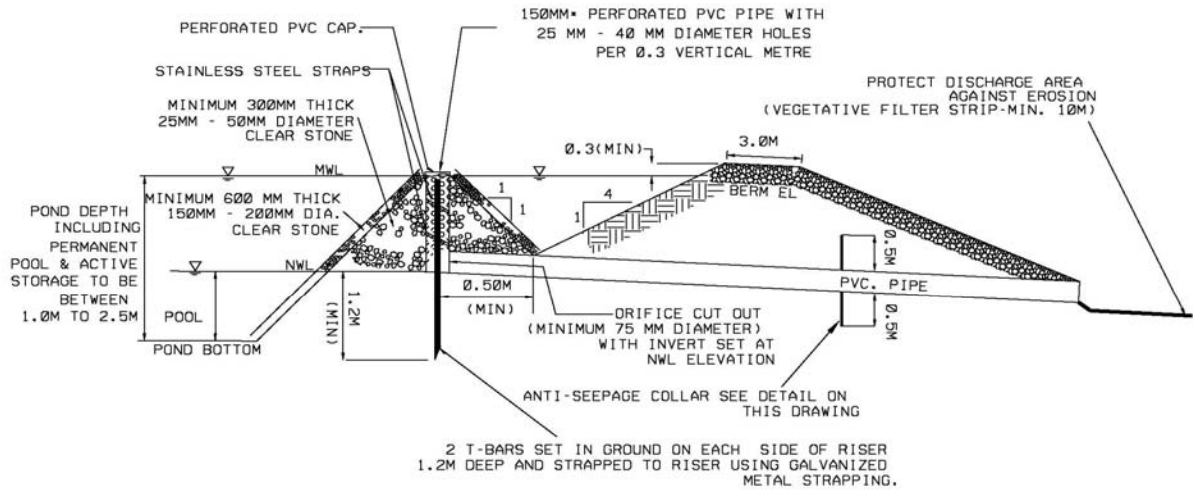

**SECTION A-A**

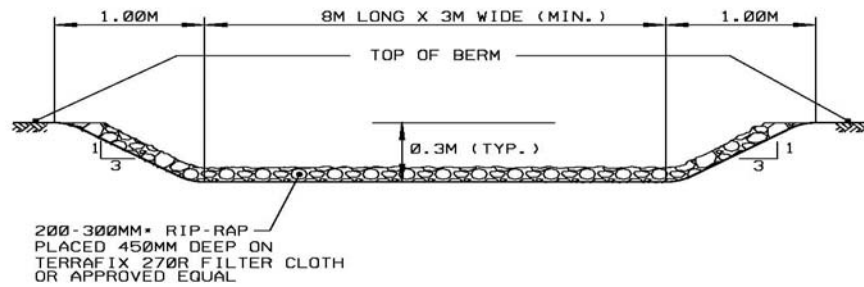

**SECTION B-B  
EMERGENCY WEIR**

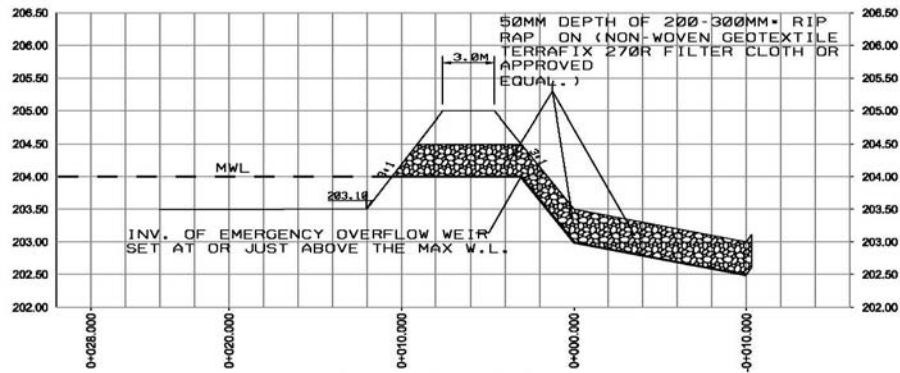

**SECTION C-C  
EMERGENCY WEIR PROFILE**

## STORM DRAIN OUTFALL PROTECTION

### *DEFINITION & PURPOSE*

Storm drain outfall protection consists of structurally lined aprons or other acceptable energy dissipating devices placed at the base of pipe or channel outlets. The outfall protection prevents scour at these outlets and minimizes the potential for downstream erosion by reducing the velocity of concentrated flows. (See figure below)

### *APPLICATION*

Outfall protection should be applied at the base of any stormwater outfall structure including, drainage tiles, stormwater facility outlets, and piped or channel conveyance systems. Storm drain outfalls are applied to areas with concentrated flows.

### *DESIGN CONSIDERATIONS*

- Outfall designs are encouraged to blend in with the environment by using natural materials such as native vegetation, and armour stone where possible. These should be placed in as natural a configuration as possible while still retaining their function;
- Most outfalls require some minimal amount of riprap stone to prevent scour of the receiving channel. Riprap stone must be underlain with a geotextile (or graded aggregate filter), covered with a stone base, and be sized to resist the tractive forces of the flow from the outfall as well as the lateral flow of the receiving channel. Typically the minimum diameter of riprap stone should be 300 mm;
- Outfall pipes and structures must be aligned so that lateral flows in the receiving channel do not erode in the vicinity of the exposed structure;
- Velocities greater than 3.0 m/s may require structural stilling basins, chute blocks or other structural measures to reduce velocities and erosion/scour impacts; and,
- In many cases the receiving channel is a grass lined ditch. The typical threshold velocity before a well-grassed channel begins to erode is 1.2 m/s. Any storm drain outfall protection in this situation must limit velocities to this threshold maximum.

### *INSTALLATION & MAINTENANCE CONSIDERATIONS*

- Installation of outfall structures must follow specifications regarding riprap stone size, geotextile etc., in order to prevent failure of the measure; and,
- Outfall protection must be in place prior to any conveyance of runoff through the outfall structure.

Figures illustrating a storm drain outfall protection from Sediment & Erosion Control on Construction Sites – Field Guide (University of Virgin Islands, 2003)

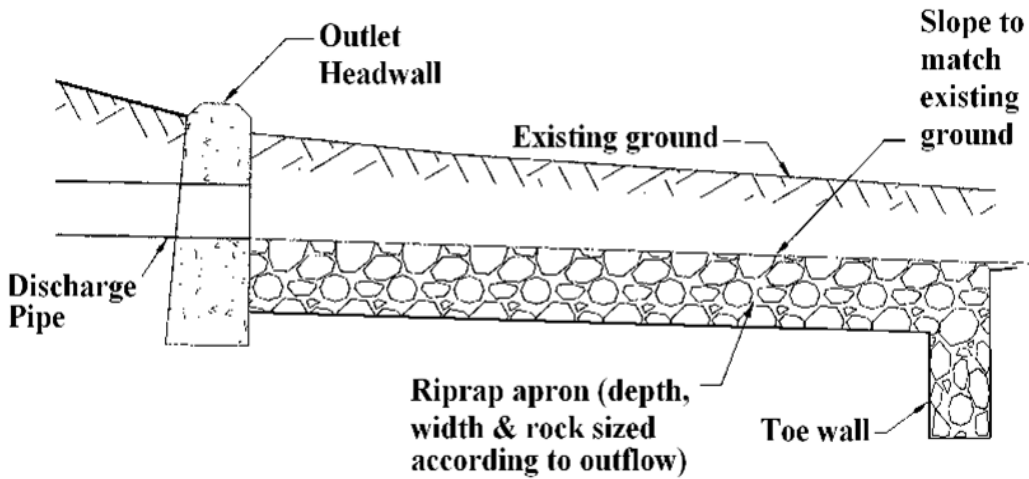
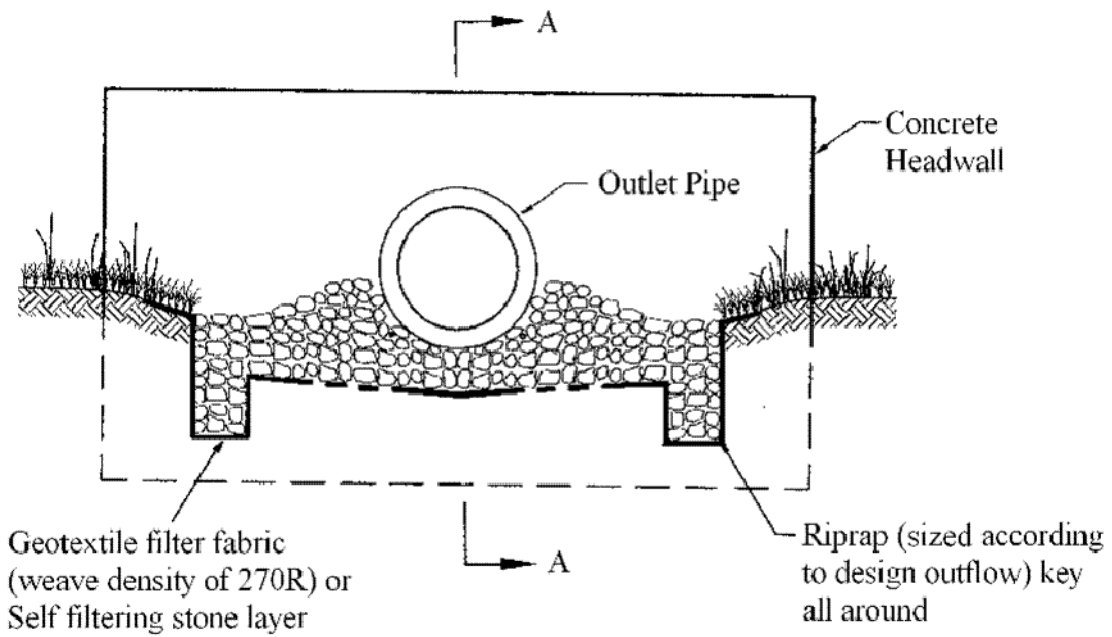

## **FILTRATION CONTROLS**

Filtration is the process in which sediment laden water passes through a porous media (e.g. geotextile, sand) consisting of small voids to trap the suspended sediment. The mechanism that makes each mitigation method effective must be understood when considering appropriate application of ESC measures. The number of barriers that may be required to trap sediment before it reaches the aquatic ecosystem will also determine the effectiveness of the mitigation methods.

**Table C4** below, lists the filtration control measures commonly utilized during the construction process.

**Table C4. Filtration Control Practices**

Name	Applicability						Applications	Temporary	Permanent	Reference Page
	Slopes	Streams/Rivers	Surface Drainage ways	Table Lands	Borrow/Stockpile	Adjacent Property				
Storm Drain Inlet Protection			√	√			Sediment control barrier consisting of either a filter fabric around the catchbasin inlet with crushed stone over the grate or filter fabric inserted inside the catchbasin.	√		C-63
InletSoxx Inlet Protection			√	√			Continuous tubular, knitted, mesh, netting filled with filtermedia and placed around inlets and drains to filter contaminants from water while also creating a sediment control barrier.	√		C-64
Sediment Bags			√	√			Geotextile material constructed into a rectangular configuration. Sediment laden runoff/discharge is pumped into the sediment bag where the suspended sediment is filtered out	√		C-67
Filter Rings			√	√			Single, multiple or stackable rings made of continuous tubular, knitted, mesh, netting, filled with a filtermedia, that provides filtration of contaminants and removes sediment when de-watering or as a concrete vehicle wash-out areas	√		C-68



## **STORM DRAIN INLET PROTECTION**

### *DEFINITION & PURPOSE*

Storm drain inlet protection consists of a sediment control barrier either around or in the catchbasin inlet. The inlet protection filters runoff before it is released to the sewer system. Drain/sewer inlet protection reduces the amount of sediment entering the storm drainage system prior to the permanent stabilization of disturbed areas.

### *APPLICATION*

Storm drain inlet controls are implemented to existing frame and grate catchbasins that receive runoff from drainage areas of 1 hectare or less.

### *DESIGN CONSIDERATIONS*

- The local Conservation Authority and municipality should be contacted to confirm use of this sediment control measure.
- Inlet protection generally provides limited sediment removal and should not be used as the principle, means of sediment control.
- All storm inlets which are operable during construction must be protected to limit sediment from entering the conveyance system.
- Refer to Inletsoxx™ for inlet protection for additional details.

## **INLETSOXX™ FOR INLET PROTECTION**

### *DEFINITION & PURPOSE*

Inletsoxx™ are used as a storm drain inlet protection by providing filtration of water and physical barrier that reduces the rate at which sediment-laden water can enter the storm drain. Inlet protection allows construction to continue while protecting storm systems from sediment overloads. Inletsoxx™ offer unique 3 way filtration, unavailable in most other types of erosion and sediment control devices, by including physical (settling of solids), chemical (some binding of metals and nutrients) and biological (some destruction of harmful substances) filtration from the unique filter media blend contained in the netting materials.

### *APPLICATIONS*

This work shall consist of furnishing, installing, maintaining and dispersing (if needed) a water permeable filtermedia filled inletsoxx™ to contain soil erosion and sediment by removing soil particles from water moving off site into adjacent waterways or storm water drainage systems. Inletsoxx™ will be used as a form of inlet protection for operational storm drainage systems. Inlet protection using Inletsoxx™ is not considered to be a primary means of sediment control and should be used within an overall integrated erosion and sediment control program. The blocking of the storm drains by the use of Inletsoxx™ should be considered in the overall site planning, especially where ponding water will create disturbances.

### *DESIGN CONSIDERATIONS*

- Inletsoxx™ shall either be made on site or delivered to the jobsite using Inletsoxx™ materials in a 5 mil monofilament or heavy duty multifilament continuous, tubular, HDPE 9.38mm knitted mesh netting material, filled with filtermedia passing the specifications for filter media derived from a composted product.
- Inletsoxx™ netting materials are available only from Filtrexx Canada Inc. and are the only Certified mesh materials accepted. Standard colour coding systems include Yellow and Black 20cm, Orange and Black 30cm, or Red and Black 45cm striped mesh netting with 9.38mm mesh openings for inlet protection.

#### Specifications FilterMedia Derived from a Composted Product

- Filtermedia used for Inletsoxx™ shall be weed free and derived from a well-decomposed source of organic matter. The filtermedia shall be produced using an aerobic composting process meeting or exceeding, M.O.E. 101, C.C.M.E. Type “A” and “AA” regulations, and Compost Quality Alliance Program (CQA), including time and temperature data indicating effective weed seed, pathogen and insect larvae kill. The filtermedia shall be free of any refuse, contaminants or other materials toxic to plant growth. Non-composted products will not be accepted. Test methods for the items below should follow USCC TMECC guidelines for laboratory procedures:
  - PH – 5.0-8.0 in accordance with TMECC 04.11-A, “Electrometric pH Determinations for Compost”
  - Particle size – 99% passing a 50mm sieve and a minimum of 70% greater than the 9.38mm sieve, in accordance with TMECC 02.02-B, “Sample Sieving for Aggregate Size Classification”. (In the field, the product commonly requested is between 12.5mm and 50mm particle size).

- Moisture content of less than 60% in accordance with standardized test methods for moisture determination.
- Material shall be relatively free (<1% by dry weight) of inert or foreign man made materials.
- A sample shall be submitted to the engineer for approval prior to being used and must be a certified Filtrexx filter media which also complies with all local, provincial and federal regulations.

### *INSTALLATION & MAINTENANCE CONSIDERATIONS*

- Inletsoxx™ will be used as a form of inlet protection on construction sites that require protection against sediment-laden water after storm drains become operational.
- Inletsoxx™ will be placed at locations indicated on plans as directed by the Engineer. Inletsoxx™ should be installed in a pattern that allows complete protection of the inlet area.
- Installation of Inletsoxx™ will ensure a minimal overlap of at least one foot on either side of the opening being protected. The Inletsoxx™ will be anchored to the soil behind the curb using staples, stakes or other devices capable of holding the Inletsoxx™ in place.
- Standard sizes of Inletsoxx™ for inlet protection will be 20cm diameter products. In severe flow situations, larger Inletsoxx™ may be recommended by the Engineer.
- Inletsoxx™ shall be constructed of 5 mil monofilament or heavy duty multifilament continuous, tubular, HDPE 9.38mm knitted mesh netting material and filled with a filter media product that passes the criteria listed in filtermedia specs
- ***If the Inletsoxx™ becomes clogged with debris and sediment, they shall be maintained so as to assure proper drainage and water flow into the storm drain. In severe storm events, overflow of the Inletsoxx™ may be acceptable in order to keep the area from flooding.***
- The Inletsoxx™ shall be positioned so as to provide a complete physical barrier to the drain itself, allowing sediment to collect on the outside of the Inletsoxx™. See attached schematic for Inletsoxx™ Installation.
- For drains and inlets that have only curb cuts, without street grates, a spacer is required in order to keep the Inletsoxx™ away from the drain opening. This spacer can be 2x4 bracing or simply standard concrete block. Use at least one spacer for every 1.2m of curb drain opening.
- The Installer shall maintain Inletsoxx™ in a functional condition at all times and it shall be routinely inspected.
- The Installer shall remove sediments collected at the base of the Inletsoxx™ when they reach 1/3 of the exposed height of the Inletsoxx™, or as directed by the Engineer.
- The Inletsoxx™ will be dispersed on site when no longer required, as determined by the Engineer. The mesh netting material will be disposed of in normal trash containers or removed by the contractor.
- Regular maintenance includes lifting the Inletsoxx™ and cleaning under them as sediment collects.

- Installer is responsible for establishing a working erosion control system and may, with approval of the Engineer, work outside the minimum construction requirements as needed.
- Installer is required to be certified determined by Filtrexx Canada Inc. Certification shall be considered current if appropriate identification is shown during time of bid or at time of application.



## SEDIMENT BAGS

### *DEFINITION & PURPOSE*

Sediment bags consist of UV stabilized, geotextile material sewn into a rectangular bag structure and are used to filter out suspended sediment from dewatering discharge. For smaller sites, sediment bags are often a more economic and effective method of filtering sediment laden waters than sediment basins or ponds. (See figure below)

### *APPLICATION*

Sediment control for the dewatering of sediment laden runoff from a construction area. Sediment bags are usually utilized as part of the ESC measures for in-stream works or when dewatering is required for a construction site. Sediment laden water from the construction site must be treated prior to entering the watercourse.

### *DESIGN CONSIDERATIONS*

- Only sediment laden water should be pumped to the sediment bag.
- ***Sediment bags are manufactured in various sizes (typically with a standard width and varying length) and are pre-sealed on all sides except for a small opening on one end, adequately sized for a dewatering hose;***
- Refer to manufacturer's specifications for capacity and sizing details as well as proper installation (i.e. clamping procedure); and,
- Sediment bag should be located on a grassed area a minimum of 30m (coldwater creeks) and 10m (warmwater creeks) away from the receiving waterbody. If a suitable grassed location is not available/possible, the filter bag will need to be placed on top of a rock pad and surrounded with sediment fencing or approved equivalent.

### *INSTALLATION & MAINTENANCE*

- The sediment bag must be securely clamped to the outside of the discharge hose to form a secure seal; and,
- The bag must be routinely monitored for efficiency (i.e. outflow) and deficiencies in the bag and hose clamp, and replaced or repaired accordingly.

Example of a sediment bag from Sediment Filter Bag – Pennsylvania Groundwater Association Inc.



## **FILTER RINGS™**

### *DEFINITION & PURPOSE*

Filter Rings™ are to be used for temporary filtration in situations that allow space for separation of water from solids in a passive manner. Filter Rings™ are a scalable system for filtering a number of contaminants from stormwater, sump water, and other situations requiring filtration prior to offsite discharge. Scaleable filtration is available via sizes in diameter, changing filtration rate of material, increasing ring diameter or adding additional Filter Rings™. Filter media used in the Filter Ring™ also has the ability to bind various contaminants contained in the runoff.

### *APPLICATION*

Use Filter Rings™ in areas where dredging slurry or high water content effluent create problems with water quality. This might include pump around situations in stream bank construction projects, overflow situations and other temporary pumping projects. It is imperative to have enough space on site to allow water to percolate through the FilterRing™ and drain away, leaving the sediment or filtrate behind (e.g. concrete truck washout area).

### *DESIGN CONSIDERATION*

- Filter Rings™ are designed to be used outdoors and are subject to ambient weather conditions. Additional rainfall may reduce speed and effectiveness. During project design, flow through rates should be selected that match design goals for the project.
- See specifications. Filter Rings™ are friendly in design because if the flow rates are higher or lower than expected, new ones may be constructed larger or smaller in diameter to accommodate the difference. If more than one ring is required to slow filtration water, leave a minimum of .3m spacing between Filter Rings™.
- In general, the Filter Rings™ are installed in a circular pattern. However, depending on the site conditions, many other shapes may be used, including a partially open horseshoe or half circle.
- The ends of the Filter Rings™ should be overlapped and staked (see figures below). In areas of poor ground contact, additional stakes should be added every 0.6 -1.5m. On pavement or concrete applications, Filter Rings™ should be depressed when installed in order to maximize ground contact and footprint.
- Filter Rings™ are a passive filtration device and operate based on a constant or reducing flow through rate. Care must be taken to not under estimate the amount of water and effluent going into the ring so that the ring size has an adequate filtration capacity.

### *INSTALLATION & MAINTENANCE CONSIDERATIONS*

- Filter Rings™ will be used as a form of drainage channel protection on construction sites, which require protection against sediment-laden water.
- Filter Rings™ will be placed at locations indicated on plans as directed by the Engineer or Conservation Authority.
- Installation of Filter Rings™ will ensure that the Filter Rings™ exceed the normal drainage area by at least 1.2m on the upslope of both banks. The Filter Rings™ will be anchored to the soil using stakes where required.

- Standard sizes of Filter Rings™ for inlet protection should be 30cm diameter products. In severe flow situations, the Engineer may recommend larger Filter Rings™ or can be stacked one on top of the other, if additional height is required.
- Filter Rings™ shall be constructed of a HDPE 9.38mm tubular knitted mesh material and filled with a filtermedia product that passes the criteria listed in specification section.
- If the Filter Rings™ become clogged with debris and sediment, they shall be maintained so as to assure a proper drainage and water flow into the drainage channel.
- The contractor shall maintain Filter Rings™ in a functional condition at all times and it shall be routinely inspected.
- If the Filter Rings™ requires repair, it will be routinely repaired.
- The contractor shall remove sediments collected by the Filter Rings™ when they become 80% full, or as directed by the Engineer.
- The Filter Rings™ will be dispersed on site when no longer required, as determined by the Engineer. The netting material will be disposed of in normal trash containers or removed by the installer.
- For materials that are filtered and contain hazardous or toxic compounds, additional disposal requirements will be directed by the Engineer.
- For Filter Rings™ made with biodegradable netting materials, no disposal of netting will be needed.

Specification for FilterMedia Derived From a Composted Product:

- Filter Media- shall be weed free and derived from a well-decomposed source of organic matter. The focus on product selection should be for water flow thru rate and filtration. The filtermedia shall be produced using an aerobic composting process meeting or exceeding M.O.E. 101, C.C.M.E. Type “A” and Type “AA” regulations, and Compost Quality Alliance program (CQA) including time and temperature data indicating effective weed seed, pathogen and insect larvae kill. The filter media shall be free of any refuse, contaminants or other materials toxic to plant growth. Non-composted products will not be accepted. Test methods for the items below should follow USCC TMECC guidelines for laboratory procedures:
  - PH – 5.0-8.0 in accordance with TMECC 04.11-A, “Electrometric pH Determinations for Compost”
  - Particle size – 99% passing a 50mm sieve and a minimum of 70% greater than the 9.38mm sieve, in accordance with TMECC 02.02-B, “Sample Sieving for Aggregate Size Classification”. (In the field, the product commonly requested is between 12.5mm and 50mm particle size.)
  - Moisture content of less than 60% in accordance with standardized test methods for moisture determination.
  - Material shall be relatively free (<1% by dry weight) of inert or foreign man made materials.
  - A sample shall be submitted to the engineer for approval prior to being used and must be a certified Filtrex filter media which also complies with all local, provincial and federal regulations.



- Installer is required to certify as determined by Filtrexx Canada Inc. Certification shall be considered current if appropriate identification is shown during time of bid or at time of application.

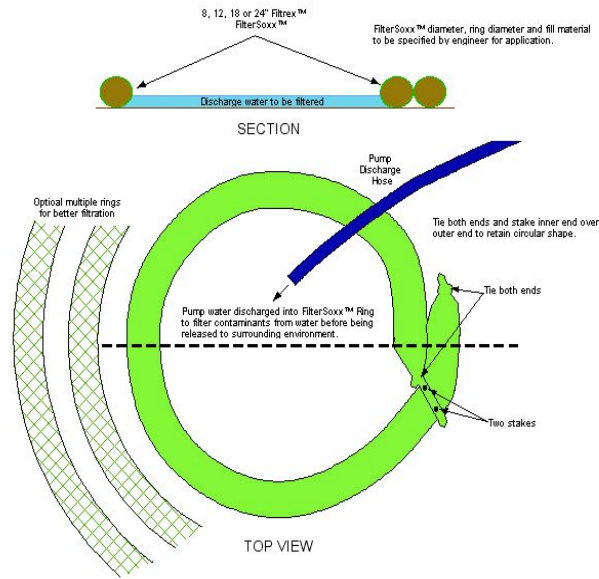

Example of Filtrexx™ Filter Ring™





---

# **APPENDIX D**

---

**SEED MIX GUIDELINES  
APRIL 2005**



# SEED MIX GUIDELINES

APRIL 2005

The GTA CAs require seed mixes to restore and stabilize disturbed soils within valley corridors and associated buffers. Unacceptable mixes can undermine the ecological integrity of valleys and other adjacent natural areas when:

- The mix is not suited to site conditions and fails to stabilize soils; sedimentation of watercourses ensues; and/or
- Aggressive alien species invade and dominate over native species. Invasive exotic species can limit the regeneration of indigenous vegetation, restrict native biodiversity and alter the nature of the ecosite.

The following guidelines are recommended when using seed mixes:

1. Seed mixes must contain native species that are suitable to the local soil, moisture, and lighting conditions. Species should be compatible and complementary to the existing vegetation communities. Some suppliers offer mixtures that are suited to various conditions, including a slope stabilization mix, meadow mix, and wetland mix. When selecting species, consideration should be given to the soil fertility and texture of the site as these are important factors in controlling the invasion of aggressive exotics since nutrient-rich, clayey, or loamy disturbed soils favour these species. Less fertile soils can sometimes support more sensitive species less tolerant of competition.
2. Attached is a list of herbaceous species that indicates whether a species is exotic or native within the GTA CAs jurisdiction. Please note the caveats indicated below. General conditions where specific species may be appropriate are indicated. Species labeled 'Problem Exotics' are generally not permitted, because they can be invasive. Species labeled 'Acceptable Exotics' are short-lived species and can be used as a nurse crop to complement native mixes, thus ensuring cover during the first year following application. If the species cannot be found in this reference, it is likely exotic and not acceptable.
3. Proposed percentages for each species in the mix should be provided. Attempt to provide between 30-50 per cent "Acceptable Exotic" species in the seed mix.
4. All disturbed areas should be seeded as soon as possible following the completion of works. Erosion controls must remain in place until seeding has sufficiently stabilized the site (i.e. more than 80 per cent cover). Works occurring during the winter months should specify interim soil stabilization measures to secure the site during the spring freshet.
5. If possible, seeds should be derived from locally adapted sources within the bioregion.
6. Seeding should not be executed during the drought-prone season (i.e. June through August), unless adequate irrigation can be supplied.
7. In general, a minimum of 15 cm of topsoil should be applied to disturbed areas prior to seeding applications. Topsoil and mulch should be carefully selected, as they can contain seeds or tubers of invasive exotics, such as creeping thistle and Manitoba maple.
8. In instances where seedbank salvage operations are employed, stockpiled soil should be stabilized over winter using a tackifier or mulch.

*NB:* This document is dated April 2005 and is consistent with current policies adopted by the GTA CAs. These guidelines are not meant to be exhaustive but present the typical requirements of the GTA CAs and are subject to change.

### *SEED MIX SPECIES LIST CAVEATS*

Attached is the list of suitable species for seed mixes within the GTA CAs jurisdiction, based upon several general site criteria. Please note that:

1. This is a working list of species that may be appropriate for seed mixes in the GTA CAs jurisdiction, and may be subject to additions, subtractions, or other changes.
2. The species on this list will be subject to availability. Some of these species are not available in seed mixes at this time.
3. Many of the more common species can be directly collected as seed heads from roadsides and wetlands, such as tall goldenrod, and do not need to be grown for harvest. Rare native successional plants (which have largely been replaced by the exotics) need to be propagated first, to produce a seed source that can be harvested.
4. Site conditions are assumed to be open, sunny, newly disturbed, but distinguished according to soil and moisture considerations. Note that the clay/loam is very different from clay barren. The former is rich, heavy soil (not pure clay and often with topsoil) that grows in fast with weedy species, and is by far the most common situation one would encounter. This category represents soil that is typical of natural forest soil in the TRCA region and tree planting should be considered. Clay barren is exposed subsoil that supports a very thin growth of plants, including however, some rare species that cannot compete with more tolerant species, such as tall goldenrod.
5. Note that a few woody plants such as paper birch have been included. These have small, storable seeds that can be easily thrown into a seed mix, and tend also to be tricky to transplant, so seeding might be better than using nursery stock, or at least as an adjunct to direct planting.

**TABLE D1: Seed Mix Summary List.**

April 2005		Dry	Clay	Clay Loam	Wetland /	Special	Acceptable	Problem	Native
		Sandy	Barren /	(generally)	(storm water)	Prairie &	Exotics	Exotics	Exotic
Scientific name	Common Name	Sites	Subsoil	(fertile sites)		Coastal	(short-lived)		Exotic/Invasive
<i>Achillea millefolium ssp. lanulosum</i>	woolly yarrow	x	x	x					Native
<i>Acorus americanus (A. calamus misapplied)</i>	sweet flag				x				Native
<i>Agrostis scabra</i>	ticklegrass				x				Native
<i>Alisma plantago-aquatica (A. triviale)</i>	water-plantain				x				Native
<i>Alopecurus aequalis</i>	short-awned foxtail				x				Native
<i>Ammophila breviligulata</i>	marram or beach grass					x			Native
<i>Amphicarpaea bracteata</i>	hog-peanut			x	x				Native
<i>Anaphalis margaritacea</i>	pearly everlasting	x							Native
<i>Andropogon gerardii</i>	big bluestem	x							Native
<i>Anemone canadensis</i>	Canada anemone			x	x				Native
<i>Anemone virginiana (inc. vs. alba, cylindroidea, riparia)</i>	common thimbleweed		x	x					Native
<i>Angelica atropurpurea</i>	angelica				x				Native
<i>Antennaria neglecta</i>	field pussytoes	x	x						Native
<i>Apocynum androsaemifolium</i>	spreading dogbane	x		x					Native
<i>Apocynum cannabinum (inc. var. hypericifolium)</i>	Indian-hemp dogbane			x	x				Native
<i>Arabis glabra</i>	tower mustard	x				x			Native
<i>Artemisia campestris ssp. caudata</i>	beach wormwood					x			Native
<i>Asclepias incarnata ssp. incarnata</i>	swamp milkweed				x				Native
<i>Asclepias syriaca</i>	common milkweed	x		x					Native
<i>Aster cordifolius</i>	heart-leaved aster		x	x					Native
<i>Aster ericoides ssp. ericoides (Virgulus ericoides)</i>	heath aster		x	x					Native
<i>Aster lanceolatus ssp. lanceolatus</i>	panicked or tall white aster			x	x				Native
<i>Aster lateriflorus</i>	calico or one-sided aster			x					Native
<i>Aster novae-angliae (Virgulus novae-angliae)</i>	New England aster			x					Native
<i>Aster oolentangiensis (A. azureus)</i>	sky-blue or azure aster	x				x			Native
<i>Aster puniceus var. puniceus</i>	swamp or purple-stemmed aster				x				Native
<i>Aster umbellatus var. umbellatus</i>	flat-topped aster			x	x				Native
<i>Aster urophyllus (A. sagittifolius)</i>	arrow-leaved aster	x							Native
<i>Astragalus canadensis</i>	Canada milk-vetch	x		x					Native
<i>Beckmannia syzigachne</i>	slough grass				x				Native
<i>Betula papyrifera</i>	paper or white birch	x		x					Native
<i>Bidens cernuus</i>	nodding bur-marigold				x				Native
<i>Bidens tripartitus (inc. B. connatus, B. comosus)</i>	three-parted beggar's ticks				x				Native
<i>Bromus latiglumis</i>	eared or tall brome				x				Native
<i>Calamagrostis canadensis</i>	Canada blue joint				x				Native

April 2005		Dry	Clay	Clay Loam	Wetland /	Special	Acceptable	Problem	Native
		Sandy	Barren /	(generally)	(storm water)	Prairie &	Exotics	Exotics	Exotic
Scientific name	Common Name	Sites	Subsoil	(fertile sites)		Coastal	(short-lived)		Exotic/Invasive
<i>Calystegia sepium</i> (incl. <i>ssp. americanum</i> , <i>angulatum</i> , <i>erraticum</i> )	hedge bindweed			x					Native
<i>Campanula aparinoides</i>	marsh bellflower				x				Native
<i>Campanula rotundifolia</i>	harebell	x				x			Native
<i>Carex alopecoidea</i>	foxtail or brown-headed wood sedge				x				Native
<i>Carex aquatilis</i>	water or Goodenough's sedge				x				Native
<i>Carex atherodes</i>	awned sedge				x				Native
<i>Carex aurea</i>	golden-fruited sedge		x		x				Native
<i>Carex bebbii</i>	Bebb's sedge			x	x				Native
<i>Carex blanda</i> ( <i>C. laxiflora</i> var. <i>blanda</i> )	common wood sedge		x	x					Native
<i>Carex brevior</i>	short-fruited sedge	x				x			Native
<i>Carex crinita</i>	fringed sedge				x				Native
<i>Carex cristatella</i>	crested sedge			x	x				Native
<i>Carex cryptolepis</i>	small yellow sedge		x						Native
<i>Carex eburnea</i>	bristle-leaved sedge		x						Native
<i>Carex flava</i>	yellow sedge		x						Native
<i>Carex granularis</i>	meadow sedge		x	x					Native
<i>Carex hystericina</i> ( <i>C. hystericina</i> )	porcupine sedge				x				Native
<i>Carex lacustris</i>	lake-bank sedge				x				Native
<i>Carex merriitt-fernaldii</i>	Fernald's sedge	x							Native
<i>Carex molesta</i>	troublesome sedge				x				Native
<i>Carex muhlenbergii</i> var. <i>muhlenbergii</i>	Muhlenberg's sedge	x				x			Native
<i>Carex pallescens</i>	pale sedge		x		x				Native
<i>Carex pellita</i> ( <i>C. lanuginosa</i> ; <i>C. filiformis</i> var. <i>lanuginosa</i> )	woolly sedge			x	x				Native
<i>Carex projecta</i>	necklace or loose-headed oval sedge				x				Native
<i>Carex pseudo-cyperus</i>	pseudocyperus sedge				x				Native
<i>Carex siccata</i> ( <i>C. foenea</i> )	sand-bank, hillside, or hay sedge	x				x			Native
<i>Carex stipata</i>	awl-fruited sedge				x				Native
<i>Carex stricta</i>	tussock sedge				x				Native
<i>Carex sychnocephala</i>	dense long-beaked sedge				x				Native
<i>Carex tribuloides</i>	blunt broom sedge				x				Native
<i>Carex trichocarpa</i>	hairy-fruited sedge				x				Native
<i>Carex vulpinoidea</i>	fox sedge			x	x				Native
<i>Ceanothus americanus</i>	New Jersey tea	x				x			Native
<i>Chelone glabra</i>	turtlehead				x				Native
<i>Chenopodium capitatum</i>	strawberry-blite	x							Native
<i>Chenopodium simplex</i> ( <i>C. hybridum</i> ; <i>C. gigantospermum</i> )	maple-leaved goosefoot	x		x	x				Native

April 2005		Dry	Clay	Clay Loam	Wetland /	Special	Acceptable	Problem	Native
		Sandy	Barren /	(generally)	(storm water)	Prairie &	Exotics	Exotics	Exotic
Scientific name	Common Name	Sites	Subsoil	(fertile sites)		Coastal	(short-lived)		Exotic/Invasive
<i>Clematis virginiana</i>	virgin's bower			x	x				Native
<i>Clinopodium vulgare (Satureja vulgaris)</i>	dogmint or wild basil	x		x					Native
<i>Comptonia peregrina</i>	sweet-fern	x				x			Native
<i>Corydalis aurea ssp. aurea</i>	golden corydalis	x							Native
<i>Crataegus macracantha (C. succulenta var. macracantha)</i>	long-spined hawthorn	x		x					Native
<i>Crataegus pedicellata</i>	scarlet or pedicelled hawthorn			x					Native
<i>Crataegus pringlei</i>	Pringle's hawthorn			x					Native
<i>Crataegus punctata</i>	dotted hawthorn			x	x				Native
<i>Crataegus submollis</i>	Emerson's hawthorn			x					Native
<i>Crataegus succulenta</i>	long-spined or succulent hawthorn			x					Native
<i>Cyperus lupulinus (C. filiculmis)(incl. ssp. macilentus)</i>	slender umbrella-sedge or galingale					x			Native
<i>Danthonia spicata</i>	poverty oat grass	x	x						Native
<i>Desmodium canadense</i>	showy tick-trefoil	x			x				Native
<i>Echinocystis lobata</i>	wild cucumber			x	x				Native
<i>Eleocharis erythropoda (E. calva; E. palustris v. calva)</i>	creeping or red-stemmed spike-rush				x				Native
<i>Eleocharis obtusa</i>	blunt spike-rush				x				Native
<i>Elymus canadensis</i>	Canada wild rye	x							Native
<i>Elymus riparius</i>	riverbank wild rye				x				Native
<i>Elymus virginicus var. virginicus</i>	Virginia wild rye				x				Native
<i>Epilobium angustifolium</i>	fire-weed			x					Native
<i>Epilobium ciliatum ssp. ciliatum</i>	sticky willow-herb				x				Native
<i>Epilobium coloratum</i>	purple-leaved willow-herb				x				Native
<i>Equisetum arvense</i>	field or common horsetail		x	x	x				Native
<i>Erigeron annuus</i>	annual or daisy fleabane	x	x	x					Native
<i>Erigeron philadelphicus ssp. philadelphicus</i>	Philadelphia fleabane			x					Native
<i>Erigeron pulchellus</i>	Robin's plantain	x							Native
<i>Erigeron strigosus (E. annuus ssp. strigosus)</i>	rough fleabane	x	x	x					Native
<i>Eupatorium maculatum ssp. maculatum</i>	spotted Joe-Pye weed				x				Native
<i>Eupatorium perfoliatum</i>	boneset				x				Native
<i>Eupatorium rugosum</i>	white snakeroot			x					Native
<i>Euthamia graminifolia (Solidago graminifolia)</i>	grass- or narrow-leaved goldenrod			x	x				Native
<i>Fragaria virginiana (incl. ssp. glauca &amp; virginiana)</i>	wild or common strawberry	x	x	x					Native
<i>Galium palustre</i>	marsh bedstraw				x				Native
<i>Galium triflorum</i>	sweet-scented bedstraw			x	x				Native
<i>Geum aleppicum (G. strictum)</i>	yellow avens			x	x				Native
<i>Geum canadense</i>	white avens			x					Native

April 2005		Dry	Clay	Clay Loam	Wetland /	Special	Acceptable	Problem	Native
		Sandy	Barren /	(generally)	(storm water)	Prairie &	Exotics	Exotics	Exotic
Scientific name	Common Name	Sites	Subsoil	(fertile sites)		Coastal	(short-lived)		Exotic/Invasive
<i>Glyceria grandis</i>	tall manna grass				x				Native
<i>Glyceria septentrionalis</i>	eastern manna grass				x				Native
<i>Glyceria striata</i> (incl. vars. <i>striata</i> & <i>stricta</i> )	fowl manna grass				x				Native
<i>Gnaphalium macounii</i>	viscid cudweed	x							Native
<i>Gnaphalium obtusifolium</i>	fragrant cudweed	x							Native
<i>Hackelia virginiana</i>	Virginia stickseed	x		x					Native
<i>Hedeoma hispidum</i>	rough pennyroyal	x							Native
<i>Hedeoma pulegioides</i>	American pennyroyal	x							Native
<i>Helianthemum bicknellii</i>	Bicknell's frostweed					x			Native
<i>Helianthemum canadense</i>	frostweed					x			Native
<i>Helianthus divaricatus</i>	woodland sunflower	x				x			Native
<i>Hieracium kalmii</i> ( <i>H. canadense</i> )	Canada hawkweed	x				x			Native
<i>Hypericum ascyron</i>	great St. Johnswort				x				Native
<i>Impatiens capensis</i> ( <i>I. biflora</i> )	orange touch-me-not (spotted jewelweed)				x				Native
<i>Iris versicolor</i>	blue flag				x				Native
<i>Juncus articulatus</i>	jointed rush		x		x				Native
<i>Juncus balticus</i>	Baltic rush					x			Native
<i>Juncus bufonius</i>	toad rush		x	x	x				Native
<i>Juncus dudleyi</i>	Dudley's rush			x	x				Native
<i>Juncus effusus</i> ssp. <i>solutus</i>	soft rush				x				Native
<i>Juncus tenuis</i>	path rush			x					Native
<i>Juncus torreyi</i>	Torrey's rush				x				Native
<i>Juniperus communis</i>	common juniper	x	x						Native
<i>Juniperus virginiana</i>	red cedar	x	x						Native
<i>Lactuca biennis</i>	tall blue lettuce			x					Native
<i>Lactuca canadensis</i>	wild lettuce			x					Native
<i>Lathyrus palustris</i>	marsh vetchling				x				Native
<i>Leersia oryzoides</i>	rice cut grass				x				Native
<i>Lepidium virginicum</i>	Virginia pepper-grass	x	x	x					Native
<i>Lespedeza capitata</i>	round-headed bush-clover	x				x			Native
<i>Liatris cylindracea</i>	cylindric blazing-star					x			Native
<i>Liatris spicata</i>	spike blazing-star					x			Native
<i>Lilium michiganense</i>	Michigan or Turk's cap lily			x	x				Native
<i>Lindernia dubia</i> var. <i>dubia</i>	false pimpernel				x				Native
<i>Lobelia inflata</i>	Indian tobacco	x							Native
<i>Lobelia siphilitica</i>	great blue lobelia				x				Native
<i>Lycopus americanus</i>	American or cut-leaved water-horehound				x				Native
<i>Lycopus uniflorus</i>	northern water-horehound or bugleweed				x				Native



April 2005		Dry	Clay	Clay Loam	Wetland /	Special	Acceptable	Problem	Native
		Sandy	Barren /	(generally)	(storm water)	Prairie &	Exotics	Exotics	Exotic
Scientific name	Common Name	Sites	Subsoil	(fertile sites)		Coastal	(short-lived)		Exotic/Invasive
<i>Lysimachia ciliata</i>	fringed loosestrife				x				Native
<i>Maianthemum stellatum (Smilacina stellata)</i>	starry false Solomon's seal					x			Native
<i>Mentha arvensis ssp. borealis</i>	wild mint			x	x				Native
<i>Mimulus ringens</i>	square-stemmed monkey-flower				x				Native
<i>Monarda fistulosa</i>	wild bergamot	x		x					Native
<i>Muhlenbergia frondosa</i>	wire-stemmed or leafy muhly grass			x	x				Native
<i>Muhlenbergia mexicana var. mexicana</i>	common muhly grass		x	x	x				Native
<i>Myosotis laxa</i>	smaller forget-me-not				x				Native
<i>Oenothera biennis</i>	common or hairy evening-primrose	x		x					Native
<i>Panicum acuminatum (P. implicatum; P. lanuginosum)</i>	hairy panic grass	x	x						Native
<i>Panicum capillare</i>	panic or witch grass			x	x				Native
<i>Panicum virgatum</i>	switch grass					x			Native
<i>Penstemon digitalis</i>	foxglove beard-tongue		x	x		x			Native
<i>Penstemon hirsutus</i>	hairy beard-tongue	x				x			Native
<i>Penthorum sedoides</i>	ditch stonewort				x				Native
<i>Plantago rugelii</i>	red-stemmed or Rugel's plantain		x	x					Native
<i>Poa compressa</i>	Canada or flat-stemmed bluegrass						x		Native?
<i>Poa palustris</i>	fowl meadow-grass				x				Native
<i>Polygonum cilinode</i>	fringed black bindweed	x		x		x			Native
<i>Polygonum scandens</i>	climbing false buckwheat	x		x	x	x			Native
<i>Potentilla arguta var. arguta</i>	tall or prairie cinquefoil					x			Native
<i>Potentilla paradoxa</i>	bushy cinquefoil					x			Native
<i>Ranunculus sceleratus</i>	cursed crowfoot				x				Native
<i>Rorippa palustris ssp. fernaldiana (R. islandica var. fernaldiana)</i>	Fernald's marsh cress				x				Native
<i>Rorippa palustris ssp. hispida (R. islandica var. hispida)</i>	hispid marsh cress				x				Native
<i>Rosa blanda</i>	smooth wild rose	x	x						Native
<i>Rubus allegheniensis</i>	common blackberry			x					Native
<i>Rubus flagellaris</i>	northern dewberry	x							Native
<i>Rubus idaeus ssp. melanolasius (R. strigosus)</i>	wild red raspberry			x					Native
<i>Rubus occidentalis</i>	wild black raspberry			x					Native
<i>Rudbeckia hirta (R. serotina)</i>	black-eyed Susan	x	x	x		x			Native
<i>Rudbeckia laciniata</i>	cut-leaved or green-headed coneflower			x	x				Native
<i>Rumex acetosella ssp. acetosella</i>	sheep sorrel	x							Native
<i>Rumex orbiculatus</i>	great water dock				x				Native

April 2005		Dry	Clay	Clay Loam	Wetland /	Special	Acceptable	Problem	Native
		Sandy	Barren /	(generally)	(storm water)	Prairie &	Exotics	Exotics	Exotic
Scientific name	Common Name	Sites	Subsoil	(fertile sites)		Coastal	(short-lived)		Exotic/Invasive
<i>Rumex verticillatus</i>	swamp dock				x				Native
<i>Sagittaria latifolia</i>	common arrowhead				x				Native
<i>Schizachyrium scoparium (Andropogon scoparius)</i>	little bluestem					x			Native
<i>Scirpus acutus</i>	hard-stemmed bulrush				x				Native
<i>Scirpus atrovirens</i>	black-fruited or dark green bulrush				x				Native
<i>Scirpus cyperinus</i>	woolly bulrush or wool-grass				x				Native
<i>Scirpus fluviatilis</i>	river bulrush				x				Native
<i>Scirpus microcarpus (S. rubrotinctus)</i>	barber-pole sedge or bulrush				x				Native
<i>Scirpus pendulus</i>	drooping, nodding, or red bulrush		x		x				Native
<i>Scirpus pungens (S. americanus)</i>	three-square or chairmaker's rush				x				Native
<i>Scirpus validus</i>	soft-stemmed bulrush				x				Native
<i>Scutellaria galericulata (S. epilobiifolia)</i>	common skullcap				x				Native
<i>Scutellaria lateriflora</i>	mad-dog skullcap				x				Native
<i>Silene antirrhina</i>	sleepy catchfly	x				x			Native
<i>Sisyrinchium montanum</i>	blue-eyed grass		x						Native
<i>Solidago altissima</i>	tall goldenrod			x					Native
<i>Solidago bicolor</i>	silver-rod or white goldenrod	x							Native
<i>Solidago canadensis var. canadensis</i>	Canada goldenrod			x					Native
<i>Solidago gigantea</i>	late goldenrod			x	x				Native
<i>Solidago hispida</i>	hairy goldenrod	x							Native
<i>Solidago juncea</i>	early goldenrod	x	x						Native
<i>Solidago nemoralis ssp. nemoralis</i>	gray goldenrod	x	x						Native
<i>Solidago rugosa ssp. rugosa</i>	rough-stemmed goldenrod			x	x				Native
<i>Solidago squarrosa</i>	stout goldenrod	x				x			Native
<i>Sorghastrum nutans</i>	Indian grass					x			Native
<i>Sparganium eurycarpum</i>	giant or great bur-reed				x				Native
<i>Spartina pectinata</i>	prairie cord grass				x	x			Native
<i>Sporobolus cryptandrus</i>	sand dropseed	x				x			Native
<i>Stellaria longifolia</i>	long-leaved chickweed				x				Native
<i>Thalictrum pubescens (T. polygamum)</i>	tall meadow rue				x				Native
<i>Typha latifolia</i>	broad-leaved cattail				x				Native
<i>Verbena hastata</i>	blue vervain				x				Native
<i>Verbena stricta</i>	hoary vervain	x				x			Native
<i>Verbena urticifolia</i>	white vervain			x	x				Native
<i>Veronica americana</i>	American speedwell or brooklime				x				Native
<i>Vicia americana</i>	American vetch	x							Native
<i>Agrostis stolonifera (A. alba var. palustris)</i>	creeping bent grass						x		Exotic?

April 2005		Dry	Clay	Clay Loam	Wetland /	Special	Acceptable	Problem	Native
		Sandy	Barren /	(generally)	(storm water)	Prairie &	Exotics	Exotics	Exotic
Scientific name	Common Name	Sites	Subsoil	(fertile sites)		Coastal	(short-lived)		Exotic/Invasive
<i>Atriplex patula</i> ( <i>A. patula</i> var. <i>hastata</i> )	halberd-leaved orache or spearscale						x		Exotic?
<i>Atriplex prostrata</i> ( <i>A. patula</i> )	spreading orache						x		Exotic?
<i>Avena sativa</i>	oats						x		Exotic
<i>Cyperus esculentus</i>	yellow nut-sedge or chufa						x		Exotic?
<i>Fagopyrum esculentum</i> ( <i>F. sagittatum</i> )	buckwheat						x		Exotic
<i>Helianthus annuus</i> (incl. <i>spps. annuus</i> & <i>lenticularis</i> )	common sunflower						x		Exotic
<i>Hordeum hystrix</i>	barley						x		Exotic
<i>Hordeum jubatum</i> ssp. <i>jubatum</i>	squirrel-tail barley						x		Exotic
<i>Lolium perenne</i> (inc. var. <i>aristatum</i> )	perennial rye						x		Exotic
<i>Panicum miliaceum</i>	millet						x		Exotic
<i>Polygonum achoreum</i>	striate knotweed						x		Exotic
<i>Portulaca oleracea</i>	purslane						x		Exotic
<i>Secale cereale</i>	rye						x		Exotic
<i>Sporobolus neglectus</i>	overlooked dropseed	x	x						Exotic?
<i>Sporobolus vaginiflorus</i>	ensheathed dropseed	x	x						Exotic?
<i>Triticum aestivum</i>	wheat						x		Exotic
<i>Agrostis gigantea</i>	<b>Red top</b>							x	<b>Exotic/Invasive</b>
<i>Bromus inermis</i> ssp. <i>inermis</i>	<b>smooth brome grass</b>							x	<b>Exotic/Invasive</b>
<i>Carex spicata</i>	<b>spiked or European meadow sedge</b>							x	<b>Exotic/Invasive</b>
<i>Chrysanthemum leucanthemum</i>	<b>ox-eye daisy</b>							x	<b>Exotic/Invasive</b>
<i>Convallaria majalis</i>	<b>lily-of-the-valley</b>							x	<b>Exotic/Invasive</b>
<i>Convolvulus arvensis</i>	<b>field bindweed</b>							x	<b>Exotic/Invasive</b>
<i>Coronilla varia</i>	<b>crown vetch</b>							x	<b>Exotic/Invasive</b>
<i>Dactylis glomerata</i>	<b>orchard grass</b>							x	<b>Exotic/Invasive</b>
<i>Elymus repens</i> ( <i>Agropyron repens</i> ; <i>Elytrigia repens</i> )	<b>quack grass</b>							x	<b>Exotic/Invasive</b>
<i>Festuca arundinacea</i> ( <i>F. elatior</i> ssp. <i>arundinacea</i> )	<b>tall fescue</b>							x	<b>Exotic/Invasive</b>
<i>Festuca pratensis</i> ( <i>F. elatior</i> var. <i>pratensis</i> )	<b>meadow fescue</b>							x	<b>Exotic/Invasive</b>
<i>Festuca rubra</i>	<b>(creeping) red fescue</b>							x	<b>Exotic/Invasive</b>
<i>Festuca trachyphylla</i> ( <i>F. longifolia</i> ; <i>F. brevipila</i> ; <i>F. ovina</i> )	<b>hard or sheep fescue</b>							x	<b>Exotic/Invasive</b>
<i>Glechoma hederacea</i>	<b>creeping Charlie or ground-ivy</b>							x	<b>Exotic/Invasive</b>
<i>Glyceria maxima</i>	<b>giant or rough manna grass</b>							x	<b>Exotic/Invasive</b>
<i>Hemerocallis fulva</i>	<b>orange day-lily</b>							x	<b>Exotic/Invasive</b>
<i>Hesperis matronalis</i>	<b>dame's rocket</b>							x	<b>Exotic/Invasive</b>
<i>Iris pseudacorus</i>	<b>yellow flag</b>							x	<b>Exotic/Invasive</b>
<i>Iris virginica</i>	<b>southern blue flag</b>							x	<b>Exotic/Invasive</b>
<i>Juncus compressus</i>	<b>round-fruited or</b>							x	<b>Exotic/Invasive</b>

	compressed rush								
April 2005		Dry	Clay	Clay Loam	Wetland /	Special	Acceptable	Problem	Native
		Sandy	Barren /	(generally)	(storm water)	Prairie &	Exotics	Exotics	Exotic
Scientific name	Common Name	Sites	Subsoil	(fertile sites)		Coastal	(short-lived)		Exotic/Invasive
<i>Linum perenne</i>	perennial flax							x	Exotic/Invasive
<i>Linum usitatissimum</i>	common flax							x	Exotic/Invasive
<i>Lotus corniculatus</i>	bird's foot trefoil							x	Exotic/Invasive
<i>Lycopus europaeus</i>	European water-horehound or bugleweed							x	Exotic/Invasive
<i>Medicago lupulina</i>	black medick							x	Exotic/Invasive
<i>Medicago sativa ssp. falcata</i>	alfalfa							x	Exotic/Invasive
<i>Medicago sativa ssp. sativa</i>	alfalfa							x	Exotic/Invasive
<i>Melilotus alba</i>	white sweet clover							x	Exotic/Invasive
<i>Melilotus officinalis</i>	yellow sweet clover							x	Exotic/Invasive
<i>Miscanthus sacchariflorus</i>	eulalia or Amur silver grass							x	Exotic/Invasive
<i>Myosotis scorpioides</i>	true or European forget-me-not							x	Exotic/Invasive
<i>Phalaris arundinacea</i>	reed canary grass							x	Exotic/Invasive
<i>Phleum pratense</i>	timothy grass							x	Exotic/Invasive
<i>Phragmites australis (P. communis)</i>	common, giant, or great reed							x	Exotic/Invasive
<i>Poa pratensis ssp. pratensis</i>	Kentucky blue grass							x	Exotic/Invasive
<i>Polygonum convolvulus</i>	black bindweed							x	Exotic/Invasive
<i>Setaria faberi</i>	giant foxtail							x	Exotic/Invasive
<i>Setaria glauca (S. pumila)</i>	yellow foxtail							x	Exotic/Invasive
<i>Setaria italica</i>	foxtail millet							x	Exotic/Invasive
<i>Setaria verticillata var. verticillata</i>	bristly foxtail							x	Exotic/Invasive
<i>Setaria viridis</i>	green foxtail							x	Exotic/Invasive
<i>Trifolium arvense</i>	rabbit-foot clover							x	Exotic/Invasive
<i>Trifolium aureum (T. agrarium)</i>	hop-clover							x	Exotic/Invasive
<i>Trifolium campestre</i>	large hop-clover							x	Exotic/Invasive
<i>Trifolium hybridum</i>	alsike clover							x	Exotic/Invasive
<i>Trifolium incarnatum</i>	crimson clover							x	Exotic/Invasive
<i>Trifolium medium</i>	zig-zag clover							x	Exotic/Invasive
<i>Trifolium pratense</i>	red clover							x	Exotic/Invasive
<i>Trifolium repens</i>	white clover							x	Exotic/Invasive
<i>Vicia cracca</i>	cow, tufted, or bird vetch							x	Exotic/Invasive
<i>Vicia sativa ssp. nigra (V. angustifolia)</i>	common vetch							x	Exotic/Invasive

---

# **APPENDIX E**

---

## **IN-STREAM CONTROL PRACTICES**



## IN-STREAM CONTROL PRACTICES

It is preferred that in-stream construction activities be avoided if at all possible. If in-stream works are necessary, it is essential that erosion and sedimentation be prevented and the associated impacts mitigated through the careful design and effective implementation of ESC measures. Often the best approach for in-stream protection is restricting the work area to as small a footprint as possible and employ controls to isolate the work area from the rest of the water body. Effective in-stream practices serve to trap sediment suspended in work area water before it leaves the site for decommissioning.

All in-stream construction activities should adhere to MNR's Fisheries Construction Timing Guidelines based on watercourse species classifications (e.g. MNR, Maple District, Fisheries Management Plan, 1989-2000). More recent watershed based Fisheries Watershed Plans provide more recent information on construction timing windows. Please be advised that a mixture of both coldwater and warmwater species may be encountered in a watercourse. In this case, the construction timing will be a combination of the warmwater and coldwater construction timing window. The presence of reddsides dace in a watercourse will also follow the warmwater/coldwater timing window combination. Local Conservation Authority or Ministry of Natural Resources staff should be consulted for site specific classifications and designated construction timing windows.

A general guideline for Maple District in-stream construction windows is listed in Table E1, below:

**Table E1 : MNR's Fisheries Construction Timing Guideline (MNR, 1989)**

Creek Classification	Construction Permitted *
WARMWATER CREEK (supports or contributes to warm water fisheries)	July 1 to March 31
COLDWATER CREEK (supports or contributes to coldwater fisheries)	June 15 to September 15
WARMWATER/COLDWATER SPECIES (both encountered in a watercourse and/or evidence of Redside Dace)	July 1 to September 15

**\* Contact the local CA to confirm the construction timing window for a specific watercourse. The Fisheries Management Plan for the Watershed and GIS thermal layers may be utilized to confirm these timing windows.**

Although there are many in-stream ESC measures that exist, Table E2 provides a list of common in-stream erosion and sediment control practices.

<b>Table E2: In-Stream Erosion and Sediment Control Practices</b>			
<b>In-Stream</b>	<b>OPSD Reference</b>	<b>Comments</b>	<b>Reference Page</b>
Auguring and Directional Drilling		Auguring consists of an excavated pit on either side of the watercourse. One pit acts as a launch point and the other as receiving point for one of the many boring techniques used to tunnel under a watercourse or other structure(s). Directional drilling utilizes machinery to drill pole type bits to tunnel through the ground. The machinery should be located outside the riparian zone.	
Sediment/Turbidity Curtains	219,260/.261	Consists of geotextile material vertically suspended in water to enclose an in-water work area and contain sediment transport to a limited area within the disturbed water body. Implemented around construction activities undertaken in-water. The sediment curtains act as a filter baffle and isolate/protect an important or sensitive in-water feature.	E-3
Temporary Stream Crossings via Culvert(s)		Consists of a raised gravel embankment constructed across a watercourse stream for use by construction vehicles. Water conveyance through the embankment is provided via culvert(s) incorporated within the gravel. Temporary crossings are intended to allow access to both sides of a watercourse at a stable concentrated point thereby limiting disruption and erosion impacts at multiple points along the watercourse.	E-6
<b>Construction in the Dry</b>	Dry Flume/By-Pass Pumping	Isolate work area by blocking the flow upstream and downstream with stone and impermeable sheeting, pea gravel bags or aqua dam. Sediment laden flow can be pumped around the site and released to a splashed pad and filter bag for treatment. A flume (CSP culvert) may be used in combination with a pumping system to assist in conveying flow. If dewatering of work area is necessary, a filter bag or sediment pond should be considered to treat discharge. Flumes may not be suitable for sensitive streams.	
	Cofferdam	A sealed structural barrier surrounding the work area adjacent to or within a watercourse channel. The cofferdam constricts the flow to the remainder of the channel (maximum 50% reduction in channel width). Material such as jersey barriers, stone and impermeable sheeting, and pea gravel bags can be utilized to create the cofferdam. Dewatering operations may be utilized to provide a dry work area.	E-8
	Temporary By-Pass or Full Diversion	By pass or full diversion may be necessary where the flume or cofferdam methods are not applicable. Construct by-pass or full diversion, leaving inlet and outlet plugged with clean rock filled material. Place filter cloth liner or approved equivalent and rip rap in channel to prevent erosion. The temporary channel must be excavated beyond the working area. For the by-pass/diversion method, a channel with a capacity to convey minimum 2 year flow should be designed.	E-10
	Site Dewatering	The removal of water within the immediate construction area to facilitate working in the dry. Discharge from dewatering must be dispersed from a riprap splash pad or constructed sediment trap through the vegetated area. The splash pad or constructed sediment trap must be set at a minimum of 30 m (coldwater creeks) and 10m (warmwater creeks) from the stream bank watercourse or sealed container.	E-12



## **SEDIMENT/TURBIDITY CURTAIN**

### *DEFINITION & PURPOSE*

Sediment or turbidity curtains consist of geotextile material that is vertically suspended in water to enclose an in-water work area. This allows for sediment transport containment to a limited area within the disturbed water body.

### *APPLICATION*

Sediment/turbidity curtains are usually implemented around construction activities requiring in-water works such as dredging or filling activities undertaken without site isolation and dewatering. They are applied to isolate and protect an important or sensitive in-water feature.

Sediment/turbidity curtains are not appropriate for use perpendicular to flowing water, margins of large rivers and on lakes/ponds.

### *DESIGN CONSIDERATIONS*

- Reduces the movement of water out of the contained work area and allow sediment to settle out of suspension;
- Geotextile curtains are suspended with floatation/buoy devices and are affixed to the base of the water body with anchors and physically secured in location with cable or rope mooring;
- Sediment curtains are produced in varying lengths typically between 30 and 100 m.
- Anchors may vary for different bed types – mud bottoms vs. sandy bottoms. Refer to manufacturer’s instructions for appropriate application and configuration.
- Refer to OPSD 219.260 and 219.261 for the Turbidity Curtain. A copy of OPSD 219.260 and 219.261 are located below.

### *INSTALLATION & MAINTENANCE*

- Curtain should be positioned at least five (5) metres outside of the perimeter of the area of disturbance.
- Floatation device should provide greater than 50 mm of freeboard.
- Curtains should be overlapped by at least 75 mm at the ends and should be sewn or threaded to form a continuous barrier.

### *NOTES*

- Proper and careful removal of the curtain following the completion of construction activities is highly important as physical disruption of the curtain may result in the re-suspension of sediment in the water column. Refer to manufacturer’s instructions for proper removal procedures.

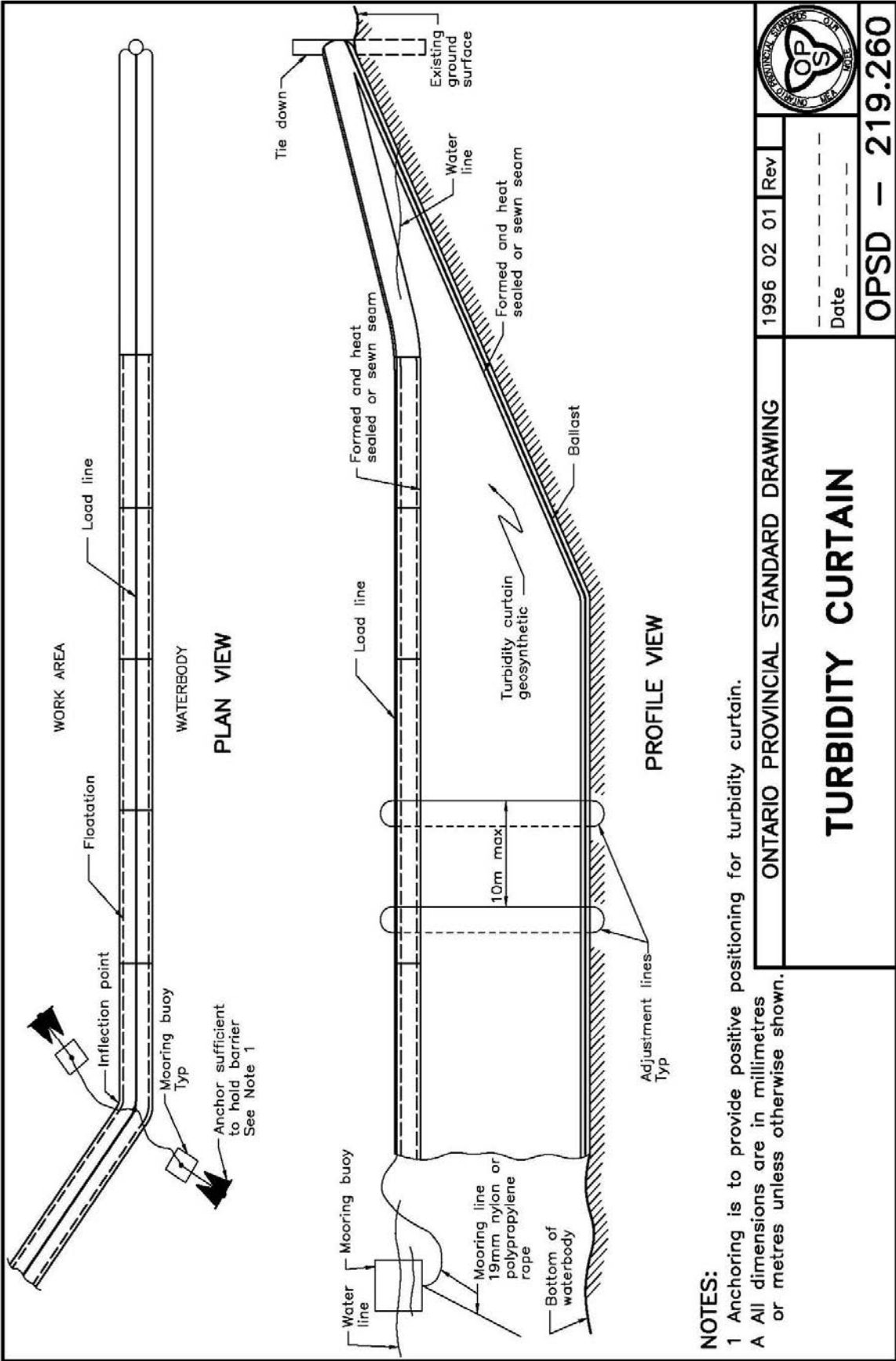

1996 02 01	Rev
---	Date

OPSD - 219.260

ONTARIO PROVINCIAL STANDARD DRAWING

# TURBIDITY CURTAIN

**NOTES:**

- 1 Anchoring is to provide positive positioning for turbidity curtain.
- A All dimensions are in millimetres or metres unless otherwise shown.

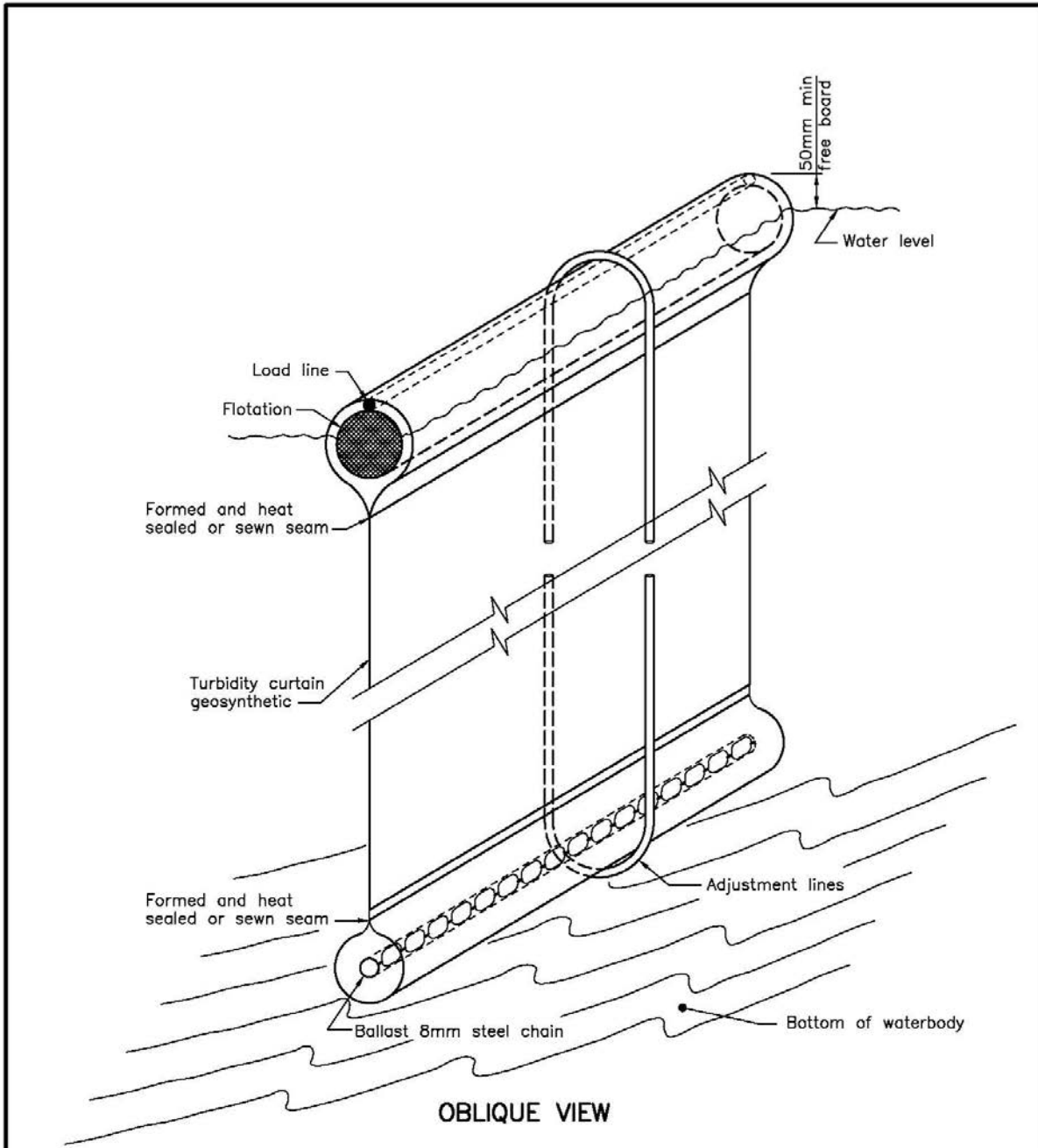

**NOTE:**

A All dimensions are in millimetres or metres unless otherwise shown.

ONTARIO PROVINCIAL STANDARD DRAWING		1996 02 01	Rev	
<b>TURBIDITY CURTAIN</b> SEAM DETAIL		Date _____		
		<b>OPSD - 219.261</b>		

## **TEMPORARY STREAM CROSSINGS VIA CULVERT(S)**

### *DEFINITION, PURPOSE & APPLICATION*

A temporary crossing consists of a raised gravel embankment constructed across a watercourse stream for use by construction vehicles. Water conveyance through the embankment is provided by culvert(s) incorporated within the gravel. Temporary crossings are intended to allow access to both sides of a watercourse at a stable concentrated point thereby limiting disruption and erosion impacts at multiple points along the watercourse.

### *DESIGN CONSIDERATIONS*

- The culvert capacity should be designed for a one in five (5) year return period storm;
- Geotextile filter fabric (270R weave density or equivalent) should be placed at the base of the channel beneath the culvert(s) and road. The geotextile must be removed with the removal of the culvert;
- Gravel such as crushed limestone or clear stone should be washed free of sediment;
- Fish presence and habitat considerations may require that the culvert be constructed in the dry – refer to the de-watering techniques;
- Culverts should be placed so they are 15% to 30% submerged during normal flow periods to provide for fish passage. However, the local Conservation Authority must be contacted to confirm the proposed alignment of the culvert;
- The outlet velocities from the culvert(s) will need to be reviewed for the provision of fish passage under high flows.
- Culverts must be long enough to establish stable fill slopes and prevent blockage, due to slope failures;
- When two culverts are required one culvert should be counter-sunk to convey low flows; and,
- A rock check dam may be required downstream of the crossing to reduce water velocities and associated erosion impacts.
- Refer to OPSD 221.040 for Temporary Water body Crossing, Fill and Culvert. A copy of OPSD 221.040 is located below.

### *INSTALLATION & MAINTENANCE CONSIDERATIONS*

- Construction in a stream should be sequenced to begin at the downstream point and work progressively upstream;
- Crossings should be inspected after every rainfall and any debris accumulation in front of culverts removed and any localized slope failures or erosion control failures repaired immediately; and,
- All materials used in the construction of temporary crossing are to be removed cautiously and completely from the watercourse following completion of equipment crossing and the channel restored to pre-existing conditions or better.

### *NOTES:*

- Use of a structure such as a baley bridge is an alternative to the use of culverts for in-stream crossings.
- Extending the structure for temporary crossing from bank to bank will avoid in-stream disturbance.

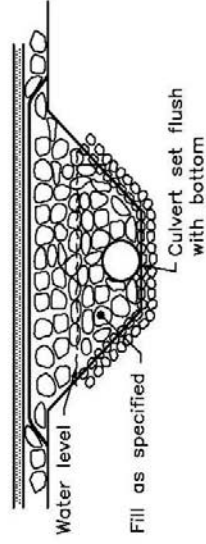
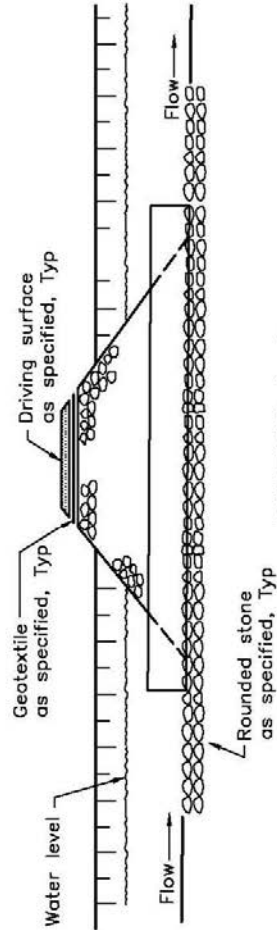
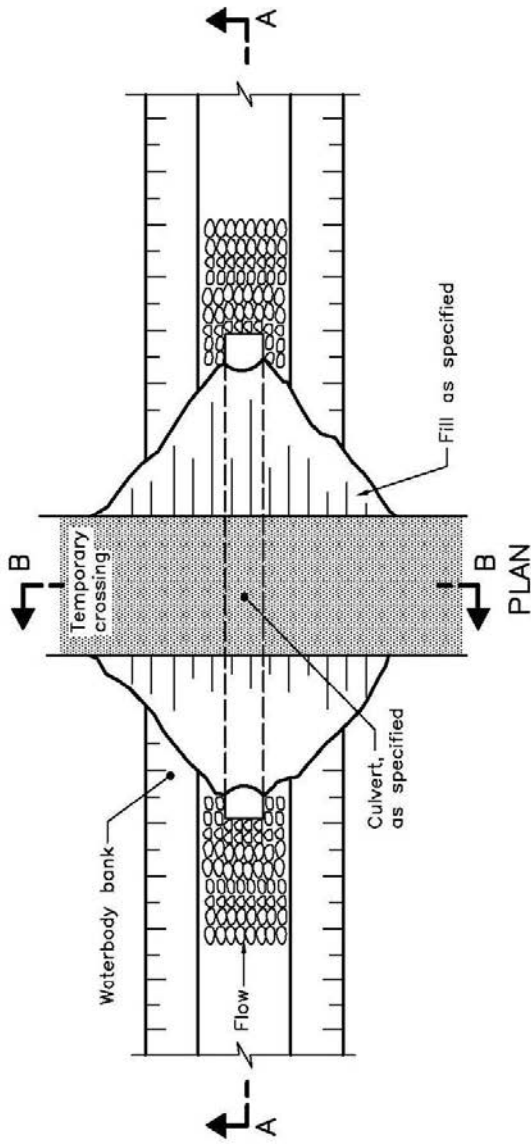

**NOTE:**

- A Approaches to the temporary crossing shall be clearly marked
- B Schematic only.

ONTARIO PROVINCIAL STANDARD DRAWING

TEMPORARY WATERBODY CROSSING  
**FILL AND CULVERT**

Nov 2000 Rev 0



OPSD - 221.040

## **COFFERDAMS**

### *DEFINITION & APPLICATION*

A cofferdam consists of a temporary dam used to isolate areas adjacent to or sections of a watercourse channel. The isolated area is to be dewatered which allows for construction to be conducted in dry conditions.

### *DESIGN CONSIDERATIONS*

- Cofferdam configurations and design details are provided in the figure below.
- Cofferdam may be constructed of pea-gravel bags, pre-cast concrete jersey barriers, sheet piling or other suitable waterproof alternatives such as an aqua dam;
- A waterproof membrane is required over the jersey barriers and may be required over the pea-gravel bags. The waterproof membrane must be keyed in under the barrier to minimize leakage;
- Pea-gravel bag dams should consist of a double line wall with a layer of impermeable liner secured between;
- The isolated work area must be dewatered according the procedures detailed in the Dewatering section;
- Dams designed to block the entire channel width will need to divert water according to the procedures detailed in Site Dewatering and Water Diversions section, or through the construction of a Temporary Stream Diversion.
- The width of the cofferdam relative to the stream channel should not be so large as to produce velocities which cause erosion of the stream bank or invert. Velocities are also a concern for the passage of fish;
- When more than 1/3 of a stream is isolated, the impact to the local channel section should be assessed by qualified personnel; and,
- The height of the cofferdam should be sufficient to prevent overtopping by a minimum of the 5 Year storm.

### *INSTALLATION & MAINTENANCE CONSIDERATIONS*

- Equipment used in constructing a cofferdam should work off the shoreline to avoid disturbing bottom sediment;
- Any required erosion protection must be placed as soon as the cofferdam is in place;
- All sediment laden water pumped from behind the cofferdam must be directed through a sediment trap or other suitable control measure prior to re-entering the stream;
- Stranded aquatic life, including fish, crayfish, amphibians, etc. should be removed by a qualified biologist as water is being pumped. Aquatic species should be transferred live in a container of clean water to upstream areas away from the work area. A fish collection permit will be required from MNR;
- Cofferdams must be removed carefully to minimize disturbance of bottom sediment. The disturbed area must be stabilized and restored immediately; and,
- No fuel or other hazardous materials should be stored behind a cofferdam. If high flows

are expected all equipment must be removed from behind the cofferdam and placed well back from the stream.

Figure illustrating coffer dams from Keeping Soil on Construction sites (HRCA & HCA, 1994).

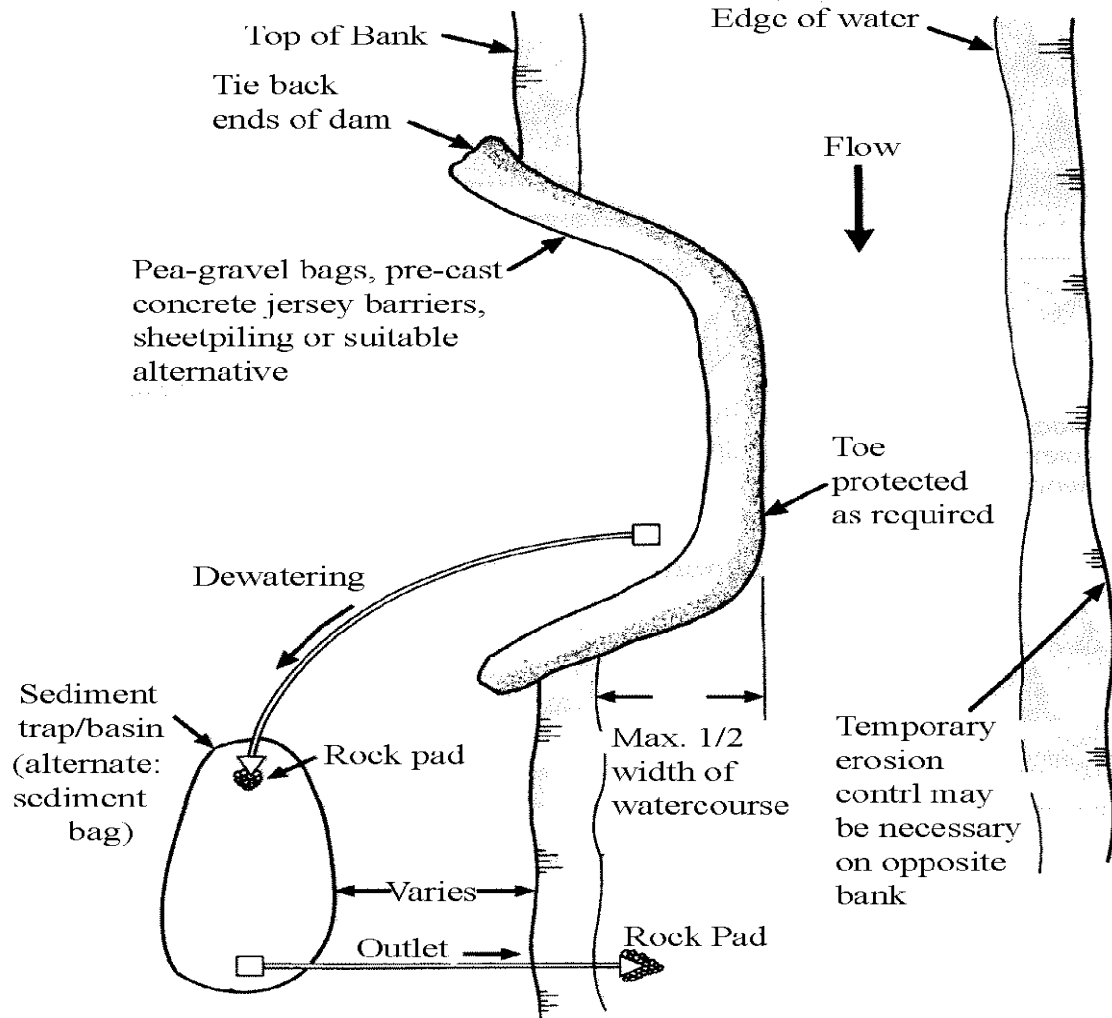

## **TEMPORARY STREAM BY-PASS OR FULL DIVERSION**

### *DEFINITION & APPLICATION*

A stream diversion relocates an existing channel temporarily and conveys water around construction activities. This can significantly reduce sediment movement downstream during construction.

### *DESIGN CONSIDERATIONS*

- Stream diversions should be utilized only when absolutely necessary and limited to as short a section as possible to minimize the impact on the natural environment;
- A temporary diversion should be sized to convey the same flow as the existing channel or structure. As a minimum the diversion must be sized to convey the 2 Year storm; and,
- Diversions must be protected from erosion with suitably sized riprap stone, erosion netting/blankets/matting, or established vegetation prior to receiving flows.
- Refer to OPSD 221.030 for Temporary Channel or Culvert Outside Watercourse. A copy of OPSD 221.030 is located below.

### *INSTALLATION & MAINTENANCE CONSIDERATIONS*

- Construction of a stream diversion must be sequenced to begin at the downstream point and work progressively upstream;
- Any soil removed to construct the diversion must be stored or disposed of away from the creek with proper sediment control measures in place such as sediment control fencing as a minimum;
- Diversions should be inspected weekly and after every rainfall and significant snowmelt event. Any localized slope failures or erosion control failures must be repaired within 48 hours of inspection;
- Decommissioning of a stream diversion must be sequenced to begin at the downstream point and work upstream; and,
- If water diversion pumping is to continue after normal working hours, a technician should be assigned to monitor and ensure that the system is functioning properly at all times.



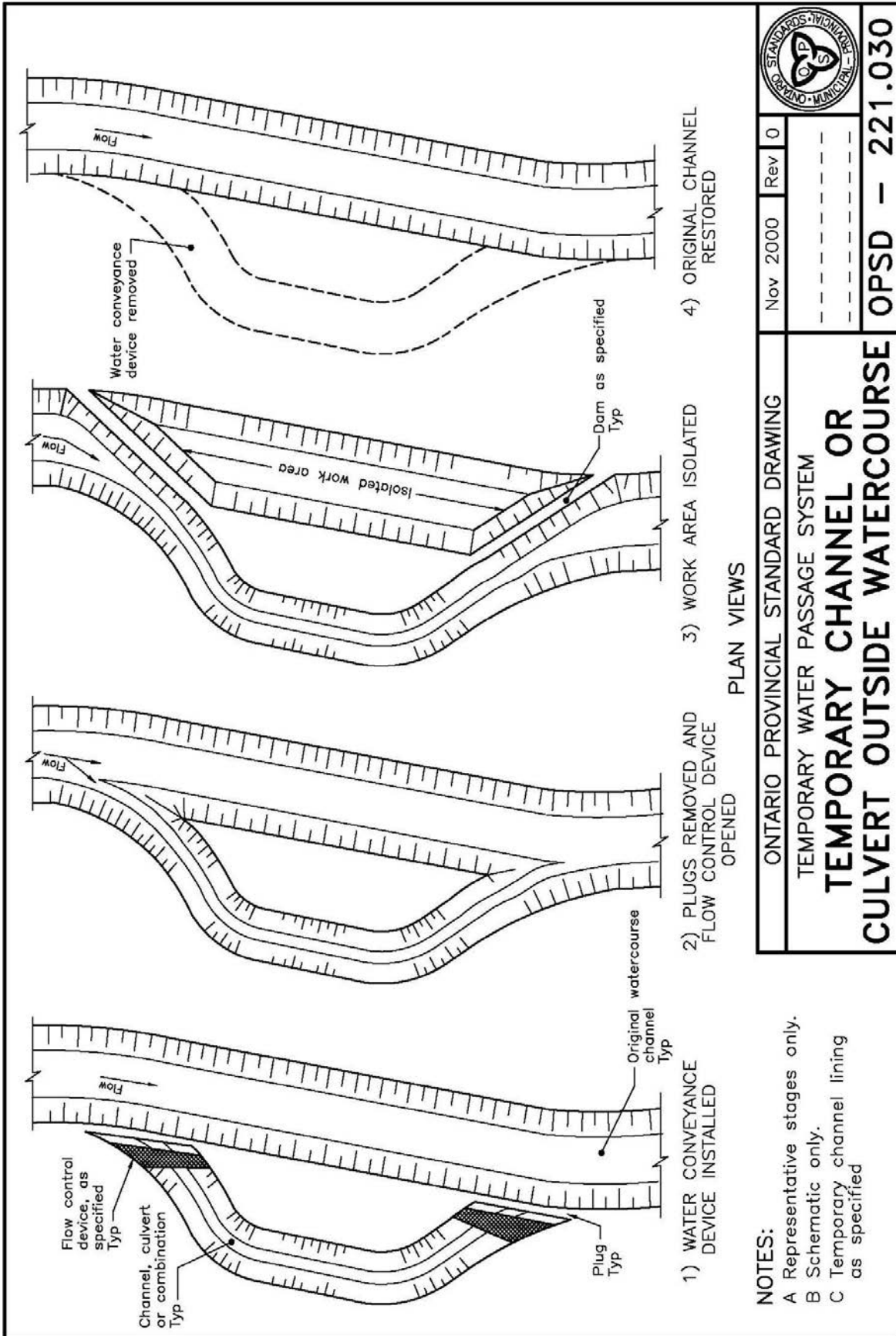

- 1) WATER CONVEYANCE DEVICE INSTALLED
- 2) PLUGS REMOVED AND FLOW CONTROL DEVICE OPENED
- 3) WORK AREA ISOLATED
- 4) ORIGINAL CHANNEL RESTORED

PLAN VIEWS

NOTES:  
 A Representative stages only.  
 B Schematic only.  
 C Temporary channel lining as specified

 ONTARIO PROVINCIAL STANDARD DRAWING		Nov 2000    Rev 0
TEMPORARY WATER PASSAGE SYSTEM <b>TEMPORARY CHANNEL OR          CULVERT OUTSIDE WATERCOURSE</b>		
		<b>OPSD - 221.030</b>

## **SITE DE-WATERING AND WATER DIVERSIONS**

### *DEFINITION & APPLICATION*

In the case that construction activities require that work be carried out within the watercourse (e.g. culvert or bridge crossing construction, retaining wall construction, erosion protection works), the work area must be dewatered to provide for construction in dry conditions. The sediment laden water pumped from the work area must be discharged to an appropriate sediment control measure for treatment before re-release to the stream. In addition, projects that dam and block flow across an entire channel section require that flows be pumped from upstream to downstream of the work area with minimum disruption to normal water levels and water quality.

### *DESIGN CONSIDERATIONS*

#### *SITE DEWATERING:*

- Refer to the figure below for dewatering details;
- The inlet pump head must be wrapped in filter fabric, situated on a bed of rip-rap within the watercourse. As an alternative to screening, a pile of clear stone may be placed over the pump to completely cover the pump head. Pumps must not entrain fish or other aquatic species;
- Outlet pump must discharge to a sediment bag or sediment trap/basin;
- Discharge from the sediment bag is to be released at a vegetated location. If unavailable, the sediment bag is to be placed over a flow dissipating structure;
- Sediment trap or basin should be protected with sediment fence installed around its perimeter; and,
- Dewatering to a well vegetated, grassed area may be permitted provided that the pump outlet head is located at least 15 meters from the receiving water body.

#### *WATER DIVERSIONS:*

- Refer to the figure below for water diversion details;
- Inlet pump head must be wrapped in filter fabric, covered with a small gauge screen (i.e. small size opening), and situated on a bed of rip-rap. As an alternative to screening, a pile of clear stone may be placed completely cover the pump; and,
- Outlet pump head to be situated on the downstream side of the area either directly within the channel or a minimum of 15 meters away from the watercourse either on a rock pad or in a well vegetated area.

### *INSTALLATION & MAINTENANCE*

- Regular inspection and cleaning of sediment controls such as sediment removal and/or filter bag replacement;
- For water diversions, a back up pump must be kept on site at all times during pumping activities;

- Water diversions/dewatering discharge must be monitored continuously for effectiveness;
- Water released to creek bank areas should be monitored for signs of erosion (i.e. sediment content of receiving stream); and,
- If water diversion pumping is to continue after normal working hours, a technician should be assigned to monitor and ensure that the system is functioning properly at all times.

Figures illustrating site dewatering and water diversions from Keeping Soil on Construction Sites (HRCA & HCA, 1994).

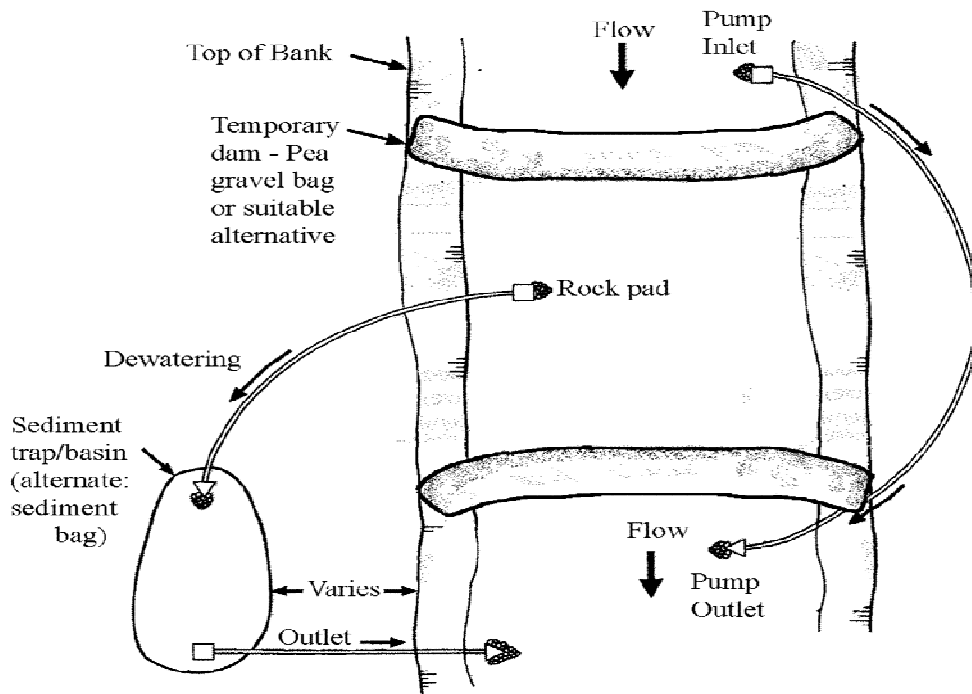



---

## **APPENDIX F**

---

**EROSION AND SEDIMENT CONTROL  
INSPECTION REPORT  
(SAMPLE)**





Erosion and Sediment Control Measure <small>(list measures that appear/should appear on ESC Plan)</small>	ESC Measure Effective			Maintenance of ESC Measure(s) required			Recommended Time for Clean-up of Measure	Inspector's Comments <small>(include location of ESC measure to be repaired)</small>	Action(s) Required
	Yes	No	N/A	Yes	No	N/A			
Silt Soxx with Compost Material								Sediment accumulation reaches 50% of Soxx height.	
Mud Mat									
Vehicle Wheel washer									
Storm Drain Outfall Protection									
<b>Sediment Control Practices - Sediment Controls:</b>									
Ditch/Swale Sediment Traps								Sediment accumulation reaches 50% of the sediment trap height.	
Sediment Traps								Sediment accumulation reaches 50% of the sediment trap height.	
Rock Check Dams								Sediment accumulation reaches 50% of the rock check dam height.	
Sediment Control Ponds/Basins								Sediment accumulation reaches 50% of the forebay design volume.	
Bulkhead within Storm Sewers									
<b>Sediment Control Practices - Filtration Controls:</b>									
Drain Inlet Protection								Refer to manufacturer's instructions to confirm clean-up time.	
Sediment Bag								Refer to manufacturer's instructions to confirm clean-up time.	
<b>In-Stream Controls:</b>									
Auguring and Directional Drilling									
Sediment/Turbidity Curtains									
Temporary Stream Crossings via Culvert(s)									
Dry Flume									
Cofferdam									
By-pass or Full Diversion									
Dewatering									



Erosion and Sediment Control Measure <small>(list measures that appear/should appear on ESC Plan)</small>	ESC Measure Effective			Maintenance of ESC Measure(s) required			Recommended Time for Clean-up of Measure	Inspector's Comments <small>(include location of ESC measure to be repaired)</small>	Action(s) Required
	Yes	No	N/A	Yes	No	N/A			
<b>General Concerns:</b>									
Are offsite/downstream properties/waterways protected?									
Have all deficiencies been repaired immediately after being reported?									
Does ESC Plan require revision?									
Photo inventory provided?									

Inspector's Signature: \_\_\_\_\_